

beko

Dryer

User Manual

Mašina za sušenje

Priručnik za korisnika



BM3T38239WBB

EN / SB

2960314097_EN/21-08-24.(11:02)



Dear Customer,

Please read this guide prior to use this product!

Thank you for choosing Beko product. We would like you to achieve the optimal efficiency from this high quality product which has been manufactured with state of the art technology. Please make sure you read and understand this guide and supplementary documentation fully before use.

Observe all warnings and information herein. Therefore you can protect both yourself and your product against potential damages.

Keep the manual. Include this guide with the unit if you hand it over to someone else.

Symbols and Remarks

The following symbols are used in the user guide:



Danger that may cause death or injury



Read the manual



Important information or useful usage tips



Warning against hot surfaces



Warning against electric shock



Warning against UV Radiation hazard



Warning against scalding



The product's packaging is made of recyclable materials, in accordance with the National Environment Legislation.



Warning against fire

NOTICE Danger that may cause material damage on the product or surrounding area

This product was manufactured using the latest technology in environmentally friendly conditions.

Table Of Contents

| | |
|---|-----------|
| 1 Safety Instructions | 5 |
| 1.1 Intended use | 5 |
| 1.2 Safety of children, vulnerable persons and pets | 5 |
| 1.3 Electrical Safety | 6 |
| 1.4 Transporting safety | 7 |
| 1.5 Installing safety | 7 |
| 1.6 Usage safety | 9 |
| 1.7 Maintenance and cleaning safety | 10 |
| 1.8 Lighting safety | 11 |
| 2 Environmental instructions..... | 12 |
| 2.1 Compliance with the WEEE Regulations and Waste Disposal | 12 |
| 2.2 Packaging information | 12 |
| 2.3 Standard conformity and test information / EU declaration of conformity | 12 |
| 3 Your drying machine | 13 |
| 3.1 Technical specifications | 13 |
| 3.2 General appearance | 14 |
| 3.3 Scope of delivery | 14 |
| 4 Installation | 15 |
| 4.1 Right place for installation | 15 |
| 4.2 Removing the shipping safety group | 15 |
| 4.3 Water connection | 16 |
| 4.4 Adjusting the stands | 16 |
| 4.5 Moving the drying machine | 16 |
| 4.6 Warning regarding the noise | 16 |
| 4.7 Replacing the lighting bulb..... | 16 |
| 5 Preparation | 17 |
| 5.1 Laundry suitable for drying in drying machine | 17 |
| 5.2 Laundry not suitable for drying in drying machine | 17 |
| 5.3 Preparing the laundry to be dried..... | 17 |
| 5.4 What to do for energy saving | 17 |
| 5.5 Correct load capacity | 18 |

| | |
|---|-----------|
| 6 Running the product | 19 |
| 6.1 Control Panel..... | 19 |
| 6.2 Symbols | 19 |
| 6.3 Preparation of drying machine | 20 |
| 6.4 Program selection and consumption chart..... | 21 |
| 6.5 Auxiliary functions..... | 23 |
| 6.6 Warning indicators..... | 23 |
| 6.7 Starting the program..... | 24 |
| 6.8 Child Lock | 24 |
| 6.9 Changing the program after it is started..... | 24 |
| 6.10 Cancelling the program..... | 25 |
| 6.11 End of program | 25 |
| 6.12 Odour feature | 25 |
| 6.13 SteamCure Odour and Wrinkle Removal Function | 25 |
| 7 Maintenance and cleaning | 27 |
| 7.1 Lint filters (internal and external filters) / Cleaning of the Interior Surface of the Loading Door | 27 |
| 7.2 Cleaning the sensor | 28 |
| 7.3 Emptying the water tank..... | 29 |
| 7.4 Cleaning the condenser..... | 29 |
| 8 Troubleshooting | 31 |

1 Safety Instructions

This section includes the safety instructions necessary to prevent the risk of personal injury or material damage.

- Our company shall not be held responsible for damages that may occur if these instructions are not observed.
- Installation and repair operations shall always be performed by Authorized Service.
- Use original spare parts and accessories only.
- Do not repair or replace any component of the product unless it is clearly specified in the operation manual.
- Do not modify the product.



1.1 Intended use

- Product is designed only for household use. It is not intended for commercial use.
- The product is not designed for outdoor use.
- Do not install or operate the product where freezing is a possibility and/or vulnerable to external elements. Water frozen in the pump or the hoses may cause damages
- Product can only be used to dry and ventilate laundry which are washed with water and drying machine safe.



1.2 Safety of children, vulnerable persons and pets

- This product may be used by children aged 8 years and older and persons with underdeveloped physical, sensory or mental capabilities or lack of experience and knowledge if they have been given supervision or instruction concerning use of the appliance in a the product safe way and the hazards involved. Children should not tamper with the device. Cleaning and maintenance should not be carried out by children unless they are supervised.
- Children under 3 years old shall be kept away from the product unless supervised.

- Electrical products are dangerous for children and pets. Children and pets shall not play with the product, climb on or get inside the product.
- Keep the product door closed even when not operated. Children or pets could be locked inside the product and suffocate.
- Cleaning and user maintenance operations must not be performed by children unless supervised.
- Keep the packaging materials away from children. Risk of injury and suffocation.
- Keep all additives used with the product away from children.
- Before disposing of the product, cut the power cord and destroy the loading door.



1.3 Electrical Safety

- The product must not be plugged in during installation, maintenance, cleaning, repair and transporting operations.
- If the power the cord is damaged, it shall be replaced by authorized service to avoid any risk that may occur.
- Do not tuck the power cord under the product or to the rear of the product. Do not put heavy items on the power cord. Power cord shall not be kinked, pinched and shall not come in contact with any heat source.
- Do not use an extension cord, multi-plug or adaptor to operate your product.
- The product shall not be powered via an external switch such as a timer or shall not be connected to a circuit that is regularly opened and closed with a tool.
- The plug shall be easily accessible. If this is not possible, a mechanism that meets the electrical legislation and that disconnects all terminals from the mains (fuse, switch, main switch, etc.) shall be available on the electrical installation.
- Do not touch the plug with wet hands.
- When unplugging the appliance, don't hold the power cord, but the plug.



1.4 Transporting safety

- Unplug the product prior to transport, empty the water tank and if any, remove the water drain connections.
- This product is heavy, do not handle it by yourself.
- Take required precautions for the product against falling and tipping. Do not crash or drop the product when transporting.
- Do not use the extruding parts of the product (such as the loading door) to move the product.
- Move the product in upright position. If it cannot be moved upright, transport via tilting to the right side when viewed from the front.



1.5 Installing safety

- To prepare the product ready for installation, ensure that the electrical installation and water drain is proper by checking the information in the user manual. If it is not suitable for installation, call a qualified electrician and plumber to arrange the utilities as necessary. These operations shall be undertaken by the customer.
- Check for any damage on the product before installing it. Do not have the product installed if it is damaged.
- Do not remove the adjustable stand.
- Place the product on a level and hard surface and balance with the adjustable legs.
- The gap between the product and the floor shall not be reduced via materials such as rugs, pieces of wood and bands. The ventilation holes under the base of the product shall not be clogged with a rug.
- The product shall be installed not to clog the ventilation holes.
- Install the product in an environment free of dust with good ventilation.
- Do not install the product in close proximity to flammable and explosive materials and do not keep flammable and explosive materials near the product when it is in operation.

- The product shall not be installed against a door, sliding door where the product loading door cannot be completely opened, or behind a hinged door where the product hinge is faced against the door's hinges.
- Install the product where periodic maintenance and cleaning can be done with ease.
- Place the product with its back surface to the wall (for heater models).
- After placing the product, ensure that the back wall does not come in contact with any extrusion (a water tap, electrical outlet etc.).
- Place the product with at least 1 cm space between the product and the furniture edges.
- Follow the flue connection rules specified in the guide (for models with flue).
- The exhaust air shall not be directed to flue which is used to exhaust the smoke of devices that consume gas or other fuels (for models with flue).
- The ventilation hose shall not be connected to a heating stove or a chimney flue (for models with flue).
- Plug the product to a grounded outlet protected with an appropriate fuse in align with the specified type and current rates. Have an expert electrician set grounding equipment. Do not use the product without a grounding conforming with regional/national regulations.
- Plug the product in a grounded socket that conforms with the voltage, current and frequency values specified in the type label.
- Do not plug the product to loose, broken, dirty, greasy sockets or sockets that has come out their seats or sockets with a risk of water contact.
- The new hose sets supplied with the product shall be used. Do not re-use the old hose sets. Do not make attachments to the hoses.
- Place the power cord and hoses not cause a risk of tripping over.
- To use the product on top of a washing machine, a fixing aperture shall be used between two products. Fixing aperture shall be mounted by the authorised service.
- When the product is placed on the washing machine, their combined weight when full could be around 180 kg. Place the products on a sturdy floor that can carry adequate amount of load.

- Washing machine cannot be placed on top of the drying machine.

| Installation Table for Washing Machine and Tumble Dryer | |
|---|---|
| Stacking Kit Type | Depth Size (TD=Tumble Dryer, WM: Washing Machine) |
| Plastic - 54/60cm w or w/o belt | 60cm TD --> WM \geq 50cm / 54cm TD --> WM>45cm |
| Plastic - 46cm w or w/o belt | 46cm TD --> WM \geq 54cm |
| With Shelf - 60cm | 60cm TD --> WM \geq 50cm |
| With Shelf - 54cm | 54cm TD --> WM>45cm |



1.6 Usage safety

- The maximum weight of dry laundry prior to washing is specified in “Technical Specifications” section.
- Do not place the unwashed items in the drying machine.
- Items that are soiled with materials such as cooking oils, acetone, alcohol, petrol, kerosene, stain removers, turpentine, wax or wax removers shall be washed in hot water with more amount of detergent prior to drying with the drying machine.
- If chemicals are utilized for cleaning, the drying machine shall not be used.
- Rubber foam (latex foam), shower bonnets, water resistant textiles, rubber supported materials and clothes, pillows with rubber foam pads shall not be dried in a drying machine.
- The items with hair spray, hair product residue or similar materials shall not be dried in a drying machine.
- Empty the pockets of the clothes and remove items such as matches and lighters.
- If all items cannot be removed rapidly and cannot be placed where heat can dissipate, do not stop the drying machine before drying cycle completed.
- The last part of the drying machine cycle is conducted without heating (cooling cycle) in order to ensure that the items are kept at a temperature that will not harm the items.

- Laundry softeners or similar products shall be used in align with the laundry softener instructions.
- Do not use the drying machine without the fibre filter.
- Do not allow fibre accumulation around the drying machine.
- To prevent back draft of gas in the room from the devices that consume other fuels, including open fire, appropriate ventilation shall be provided (for models with flue).
- Do not operate the product together with heaters such as gas heater and a chimney. It may cause the flue to catch fire. (for models with flue)
- Do not lean or sit on the loading door when it is open, the product may tip over.
- Do not get on the product.
- Do not place a source of flame (candles, cigarettes, etc.) on the product or in the vicinity of it. Do not keep flammable/explosive materials.
- Do not touch the drum as it revolves.
- The back wall of the product will be hot during operation. Do not touch the back side of the product during drying or after the drying process is completed. (For models with heating)
- Do not touch the inner surface of the drum while adding or removing clothes during a continuing program. The drum surface is hot.
- Do not press the buttons with sharp objects such as forks, knives, with your nails etc.
- Do not operate the faulty or damaged product. Unplug the product (or shut down the connected fuse) and call the authorized service.
- Unplug the product when not in use.
- Do not place the dryer in the rain or severely wet areas.



1.7 Maintenance and cleaning safety

- Do not wash the product by spraying or pouring water on it. Do not use a pressure cleaner, steam cleaner, hose or pressurised gun to clean the product.

- Do not use sharp or abrasive tools to clean the product.
- Do not use materials such as household cleaning agents, soaps, detergents, gas, gasoline, alcohol, wax, etc. to clean the product.
- The fibre filter shall be regularly cleaned. After each drying cycle, clean the fibre filter and the inner surface of the loading door.
- Clean the fibre accumulation on the fins of the evaporator behind the filter drawer with a vacuum cleaner. You can clean by hand, provided you wear protective gloves. Do not try to clean with bare hands. Evaporator fins may damage your hands. (For products with heat pump)
- Due to fire and explosion hazard, do not use solutions, cleaning materials, steel wool or similar materials and tools to clean sensors.
- Clean the flue. (for models with flue)
- Do not drink the condensed water.



1.8 Lighting safety

- Contact an authorized service when you need to replace the LED/bulb using for lighting (for products with lighting).

2 Environmental instructions

2.1 Compliance with the WEEE Regulations and Waste Disposal



This product does not contain the dangerous and prohibited materials indicated in the “Regulation on The Control of Waste Electrical and Electronic Equipment” published by Ministry of Environment and Urbanisation of Republic of Turkey. Complies WEEE Regulations. This product was manufactured from recyclable and reusable high quality parts and materials. Therefore, do not dispose of this product with other domestic wastes at the end of its life cycle. Take it to a collection point for electrical and electronic equipment. You can ask your local administration about these collection points. You can help protect the environment and natural resources by delivering the used products for recycling.



Also R290 is a flammable refrigerant. Therefore ensure that the system and pipes are not damaged during operation and transportation.

Keep the product from heat sources, otherwise it may catch fire if damaged.

Do not dispose of the product by throwing it into fire.

2.2 Packaging information

The product’s packaging is made of recyclable materials, in accordance with the National Legislation. Do not dispose the packaging waste with the household waste or other wastes, dispose it to the packaging collection areas specified by local authorities.

2.3 Standard conformity and test information / EU declaration of conformity



The development, manufacturing and sales phases of this product is conducted in conformity with the safety rules specified in all related instructions of the European Union.

3 Your drying machine

3.1 Technical specifications

EN

| | |
|-------------------------|--------------------|
| Height (Min. / Max.) | 84,6 cm / 86,6 cm* |
| Width | 59,8 cm |
| Depth | 54,5 cm |
| Capacity (max.) | 8 kg** |
| Net weight (\pm %10) | 42 kg |
| Voltage | See type label*** |
| Rated power input | |
| Model code | |

* Min. height: Height with the adjustable stand closed.

Max. height: Height with the adjustable stand opened at maximum height.

** Weight of dry laundry before washing.

*** Data plate is under the door on the drying machine.



In order to increase the drying machine's quality, the technical specifications may be changed without prior notice.

Figures in this manual are schematic and may not exactly match the product.





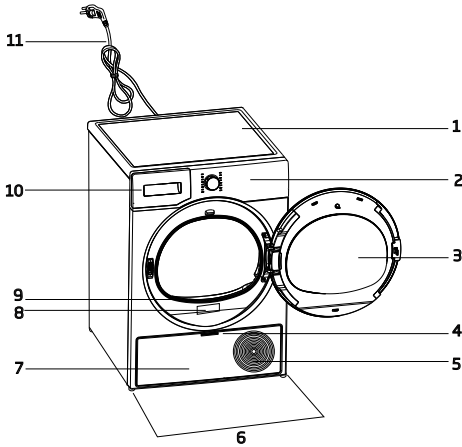



The values provided with the drying machine or its accompanying documents are laboratory readings in accordance with the respective standards. These values may differ depending on the use and ambient conditions.

3.2 General appearance

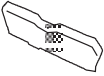

- 1. Top panel
- 2. Control panel
- 3. Loading door
- 4. Toe board handle
- 5. Ventilation grids
- 6. Adjustable feet
- 7. Toe board
- 8. Rating plate
- 9. Lint filter
- 10. Water tank drawer
- 11. Power cord

3.3 Scope of delivery

| | | | |
|---|--------------------------------|---|-------------------------|
|  | 1. Water discharge hose* |  | 6. Water filling cap* |
|  | 2. Filter drawer spare sponge* |  | 7. Pure Water* |
|  | 3. User Manual |  | 8. Odour Capsule Group* |
|  | 4. Drying basket* |  | 9. Brush* |
|  | 5. Drying basket user manual* |  | 10. Filter cloth* |

*Optional - may not be included, depends on model.

4 Installation



Read the "Safety Instructions" first!

Before consulting the nearest Authorized Service for installing the drying machine, see the information in the user guide and make sure the electric and water utilities are as required. If not, call an electrician and plumber to arrange the utilities as necessary.



It is customer's responsibility to prepare the location the drying machine shall be placed on and also have power and waste water installation prepared.



Check for any damage on the drying machine before installing it. If drying machine is damaged, do not get it installed. Damaged products cause a risk for your safety. Wait 12 hours prior to operating the drying machine.

NOTICE

The product includes a cooling agent and if the product is operated right after its transported, it may get damaged. After each time the product is moved, it shall be left to rest for 12 hours.

- Once the drying machine is installed, the connections must stay stable. After placing the drying machine, ensure that the back wall does not come in contact with any extrusion (a water tap, electrical outlet etc.).
- Place the drying machine with at least 1 cm space between the product and the furniture edges.
- Your drying machine is suitable to be operated between +5°C to +35°C. If operated outside this temperature range, your drying machine's operation may be compromised and get damaged.
- The drying machine shall not be placed with the back side against a wall.



Do not place the drying machine on its power cord.

*** Ignore following warning if your product's system does not contains R290.**



Dryer contains R290 refrigerant.* R290 is an environment-friendly, but flammable refrigerant.* Ensure that the air inlet of the dryer is open and it is well-ventilated.* Keep potential flame sources away from the dryer.*

4.1 Right place for installation

- Install the drying machine on a flat and stable surface.
- Dryer machine is heavy. Do not move it by yourself.
- Operate the drying machine in an environment free of dust with good ventilation.
- The gap between the drying machine and the floor shall not be reduced via materials such as rugs, pieces of wood and bands.
- Do not block the ventilation grilles of the drying machine.
- There shall not be doors that can be locked, sliding doors or hinged doors near the installation environment of the drying machine that may block the loading door to be opened.

4.2 Removing the shipping safety group

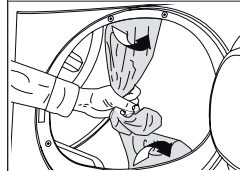

Remove the shipping safety group prior to first use the product.

NOTICE

Do not leave an accessory or any parts of the shipping safety group inside the drum.

4.3 Water connection

Instead of periodically draining the water accumulated in the water tank, you can discharge via the water discharge hose supplied with the drying machine.

Connecting the water drainage hose

| | |
|---|--|
| | <p>1-2 Remove the hose behind the drying machine by pulling it manually from where it is attached. Do not use a tool to remove the hose.</p> |
| <p>3 Insert one end of the water discharge hose supplied with the drying machine to where you have removed the hose on the drying machine.</p> <p>4 Fix the other end of the water discharge hose to directly waste water drainage or a sink.</p> | |

| | |
|----------------------|--|
| <p>NOTICE</p> | <p>The water discharge hose shall be fixed at maximum 80 cm height. Ensure that the water discharge hose do not get kinked, collapsed or pressed on between the discharge and the drying machine. Hose shall be connected not to be disconnected from its location. Leaked water may cause damage. Do not extend the water drainage hose. Check whether the water runs at an appropriate flow. The drainage line shall not be closed or clogged.</p> |
|----------------------|--|

| | |
|--|--|
| | <p>If an accessory package is provided with your product, check the detailed instructions.</p> |
|--|--|

4.4 Adjusting the stands

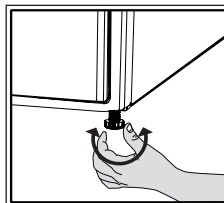

Until the drying machine stands level and sturdy, adjust the stands by turning them left and right.

4.5 Moving the drying machine

- Drain the water in the drying machine completely.
- If the product is connected via direct discharge, remove the hose connections.



The drying machine is recommended to be moved in upright position. Otherwise, tilt it to the right side when viewed from the front and move the drying machine. Wait 12 hours prior to operating the drying machine.

4.6 Warning regarding the noise

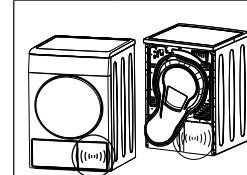

As the product is operated, metallic noises may come from the compressor from time to time, it is normal.



When the product is operated, the accumulated water is pumped to the water tank. It is normal to hear pumping sounds from the appliance during this operation.

4.7 Replacing the lighting bulb

If your drying machine has drum lighting lamp; Consult the authorized service to replace the bulb/LED used in lighting your drying machine. The bulb in this product is not suitable for home lighting. The intended use of this lamp is to ensure safely loading the laundry to the drying machine. The lamps used in this appliance is resistant to heavy physical conditions such as temperatures over 50°C.

5 Preparation



Read the "Safety Instructions" first!

5.1 Laundry suitable for drying in drying machine

NOTICE

Laundry that are not drying machine safe may damage the appliance and the laundry during drying. Follow the instructions on the labels on the laundry to be dried. Only dry the laundry with "drying machine safe" written on their labels.



Do not dry with dryer

5.2 Laundry not suitable for drying in drying machine

NOTICE

Undergarments with metal supports shall not be dried in drying machine. If these metal supports get loose and ripped from the garment, it may damage the machine.
Delicate embroidery textiles, cotton and silk garments, garments manufactured from delicate and valuable textiles, non breathing garments and tulle curtains shall not be dried in drying machine.

5.3 Preparing the laundry to be dried

NOTICE

Items such as coins, metal parts, needles, nails, screws, stones etc. may damage the drum group of the product or may cause functional operation issues. Therefore check all laundry that will be loaded to the product.

Dry the laundry with metal accessories such as zippers by turning them inside out.
Close the zippers, hooks and clasps, button up the covers' buttons, tie textile belts and apron belts.

5.4 What to do for energy saving

- Use the highest possible wringing option as you wash the laundry. Therefore you can reduce the drying period and reduce energy consumption. Sort the laundry based on their types and thickness. Dry same types of laundry together. For instance kitchen towels and table cloths dry faster than bathroom towels.
- Follow the recommendations in the user manual for program selection.
- During drying do not open the loading door unless necessary. If you are required to open the loading door, do not keep it open for too long.
- Do not add wet laundry as the drying machine operates.
- Clean the Fibre Filter before and after each drying session.
- For condensation models, be sure to clean the condenser at least once a month or after each 30 drying sessions.
- Make sure the filters are clean. Refer to maintenance and cleaning for details.
- For models with flue, follow the flue connection rules specified in the guides and clean the flue.
- During drying session, properly ventilate the environment in which the drying machine is in.
- On models with heat pump, check the condenser at least every six months and clean it if it is dirty.

- If you are using environment friendly filter, you are not required to clean the filter after every cycle. When the environment friendly icon is lit on the screen, change the filter cloth.

5.5 Correct load capacity

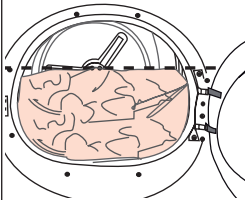
| NOTICE | |
|--|--|
|  | <p>If the laundry in the product exceed maximum load capacity, it may not operate as intended and may cause material damage or damage the product. For each program, follow the maximum load capacity.</p> |

The weights below are provided as examples.

| Laundry | Approx. weight (g)* | Laundry | Approx. weight (g)* |
|------------------------------|---------------------|-----------------------|---------------------|
| Cotton bedding (double size) | 1500 | Cotton dress | 500 |
| Bedding (single size) | 1000 | Dress | 350 |
| Bed sheet (double size) | 500 | Denim | 700 |
| Bed sheet (single size) | 350 | Handkerchief (10 pcs) | 100 |
| Large table cloth | 700 | T-Shirt | 125 |
| Small table cloth | 250 | Blouse | 150 |
| Tea napkin | 100 | Cotton shirt | 300 |
| Bath towel | 700 | Shirt | 200 |
| Hand towel | 350 | | |

*Weight of dry laundry before washing.

6 Running the product

6.1 Control Panel

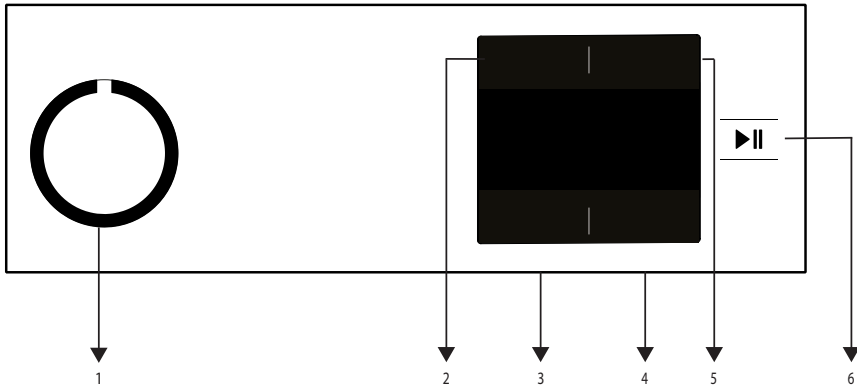

1. On/Off/Programme selection button.
2. Low temperature selection button.
3. Dryness level and Wrinkle prevention selection button.
4. End time and Child lock selection button.
5. Timer program and the audible warning selection button.
6. Start / Standby button.

6.2 Symbols

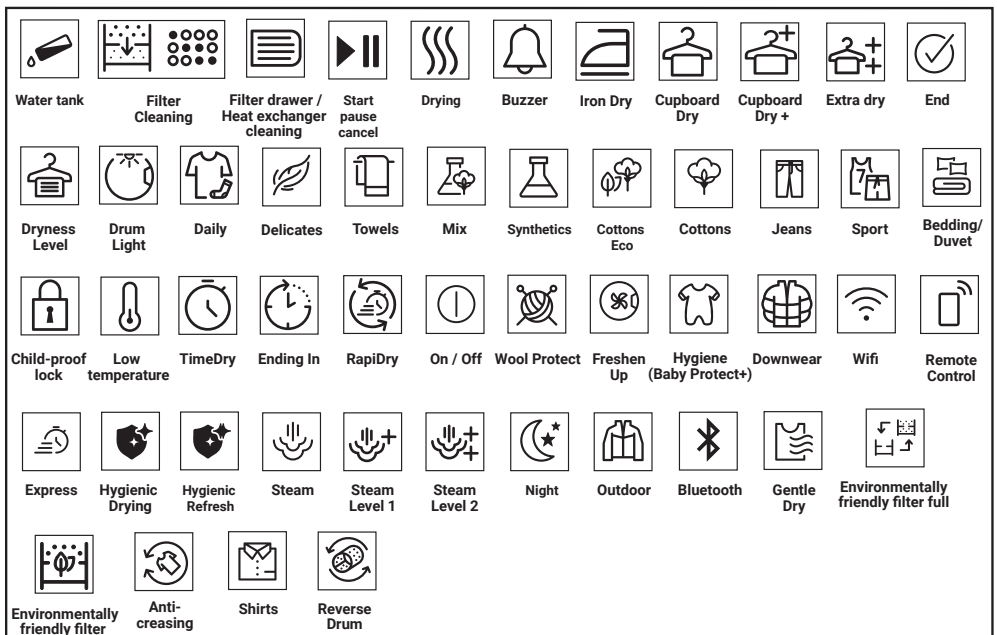

6.3 Preparation of drying machine

- Plug the drying machine.
- Open the loading door.
- Place the laundry to the drying machine without jamming them.
- Push and close the loading door.

NOTICE

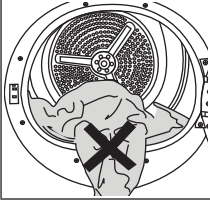

Ensure that no laundry is jammed to the loading door. Do not close the loading door with force.



- Select the desired program by using On/Off/Program Selection button, the machine will turn on.



Selecting the program with the On/Off/Program Selection button does not mean that the program started. Press Start / Stand-by button to start the program.

6.4 Program selection and consumption chart

| EN | | | | |
|--------------------------|--|---------------|-------------------------------------|-----------------------|
| Programmes | Programme Description | Capacity (kg) | Spin speed in washing machine (rpm) | Drying Time (minutes) |
| Cottons | You can dry your heat-resistant cotton textiles with this programme. A drying setting suitable for the thickness of the products to be dried and the desired level of dryness should be selected. | 8 | 1000 | 200 |
| Cottons Eco | It dries single layer, casual cotton textiles in the most economical way. | 8 | 1000 | 197 |
| Cottons Iron dry | You may dry your cotton laundry to be ironed in this program to have them slightly damp for ease of ironing. (Shirt, T-shirt, tablecloth, etc.) | 8 | 1000 | 160 |
| Synthetics | You can dry all your synthetic textiles with this programme. A drying setting suitable for the level of dryness you desire should be selected. | 4 | 800 | 75 |
| Mix | Use this programme to dry non-pigmenting synthetic and cotton laundry items together. Sports and fitness clothes may be dried with this program. | 4 | 1000 | 125 |
| Towels | Drying towels such as kitchen towel, bath towel and hand towel. | 5 | 1000 | 170 |
| Outdoor/Sports | Use it to dry your clothes made of synthetics, cotton or mixed fabrics or waterproof products such as functional jacket, raincoat etc. Turn them inside out prior to drying. | 2 | 1000 | 130 |
| Freshen Up | It only ventilates for 10-160 minutes without giving hot air. You can ventilate the cotton and linen clothes that have been enclosed for a long time with this program to remove their odour. | - | - | - |
| Time Program / Steamcure | You may select from time programmes between 10 and 160 minutes to achieve the desired drying level at low temperature. In this programme, tumble drier's operation lasts for the set time independently from the dryness of laundry. SteamCure is a refreshing function making ironing easier on less worn clothes and reducing odours (cigarette, food etc.) due to medium air. | - | - | - |
| Gentle Care | You may dry your delicate laundry or laundry with hand wash symbol (silk blouses, thin underwear, etc.) at low temperature in this program. | 2 | 1200 | 45 |
| Bedding | Dry 1 cotton or synthetic duvet cover set by closing the button / zipper. | 2 | 1000 | 121 |
| Down Wear | Turn clothes such as down coats, jackets inside out for drying. | - | 800 | 119 |

| Jeans | You may dry denim pants, skirts, shirts or jackets in this program. | 4 | 1200 | 130 |
|---|---|-------------------------------------|--|------------------------------|
| Shirts | It dries the shirts in a more sensitive manner, and causes less creasing and easier ironing. | 1,5 | 1200 | 50 |
| Hygienic Drying | It is the programme that you can dry your washed products you want to provide with extra hygiene (baby clothes, underwear, towels, etc.). It provides high hygiene for your textiles via heat effect. | 5 | 800 | 185 |
| Xpress Super Short | Use this program to have 2 shirts ready for ironing. | 0,5 | 1200 | 30 |
| Energy consumption values | | | | |
| Programmes | Capacity (kg) | Spin speed in washing machine (rpm) | Approximate amount of remaining humidity | Energy consumption value kWh |
| Cottons Eco* | 8 | 1000 | 60% | 1,84 |
| Cottons Iron dry | 8 | 1000 | 60% | 1,60 |
| Synthetics Cupboard Dry | 4 | 800 | 40% | 0,75 |
|  | "Cottons Eco programme" used at full and partial load is the standard drying programme to which the information in the label and the fiche relates, that this programme is suitable for drying normal wet Cottons laundry and that it is the most efficient programme in terms of energy consumption for Cottons. | | | |
|  | "If you regularly dry the 8 Kg maximum load of Cottons we suggest to connect the drain hose to prevent the dryer stopping mid-cycle in order to empty the tank" (see Section "Connection to the drain") | | | |

* : Energy Label Standard Program according to AS/NZS 2442. Consumption values may vary from the values in the chart depending on laundry type, spinning speed, ambient conditions and voltage levels.



Allergy UK is the trademark of the British Allergy Foundation. The Seal of Approval has been created to guide people requesting an advice that the product significantly reduces

the amount of the allergens in an environment where allergic people are present or the product restricts/reduces/eliminates the allergens. The purpose is to provide evidence that the products have been scientifically tested or analysed to yield measurable results.

6.5 Auxiliary functions Dryness level

Dryness level button is used for adjusting to desired dryness. Program time may change depending on the selection.



You can activate this function only prior to start of program.

Wrinkle prevention

You can turn the wrinkle prevention function on or off by pressing the end time button for 3 seconds. If you will not take the laundry out immediately after the program has completed, you may use Wrinkle prevention function to prevent wrinkling of your laundry.

Audible warning

Drying machine makes an audible warning when the program is completed. Press the "Audible Warning" button if you do not want audible warning. When you press the audible warning button, the light goes off and it does not sound when the program is completed.

Low Temperature

You can activate this function only prior to operation of program. If you want to dry your laundry at a lower temperature, you can activate this function. Once activated, the program will be extended.



You can select this function before the program starts or after the program starts.

End time

You can delay the end time of the program up to 24 hours with end time function.

1. Open the loading door and place the laundry.
2. Select the drying program.
3. Press the End Time selection button and set the delay time you wish. End time LED turns on. (When pressed and hold the button, End Time proceeds non-stop).
4. Press the Start / Stand-by button. End Time countdown begins. The ":" sign in the middle of displayed delay time flashes.



You can add or remove laundry within end time. Displayed time is the sum of normal drying time and end time. End Time LED turns off at the end of countdown, the drying starts and the drying LED turns on.

Changing the end time

If you want to change the duration during the countdown:

Pause the program and Turn the On/Off/ Program Selection button and cancel the program. Select the desired program and repeat the End Time selection.

Canceling the end time function

If you want to cancel the end time countdown and start the program immediately:

Pause the program and Turn the On/Off/ Program Selection button and cancel the program. Select the desired program and press the "Start/Pause" button.

6.6 Warning indicators



Warning indicators may vary depending on the model of your drying machine.

Filter cleaning

When the program is completed, the warning indicator for filter cleaning turns on.

Water tank

If the water tank fills up while the program continues, the warning indicator starts flashing and the machine goes into stand-by. In this case, empty the water tank and start the program by pressing the Start / Stand-by button. Warning indicator turns off and program resumes.

Cleaning of filter drawer/ heat exchanger

Warning symbol flashes periodically to remind that filter drawer must be cleaned.

6.7 Starting the program

Press the Start/Stand-by button to start the program.

Start/Stand-by and Drying indicators turn on to show that program started.

6.8 Child Lock

The drying machine has a child lock which prevents the program flow from being interrupted when the buttons are pressed during a program. When the Child Lock is activated, all buttons on the panel except the On/Off/Program Selection button are deactivated.

Press the End Time button for 3 seconds in order to activate the child lock. The child lock has to be deactivated to be able to start a new program after the current program is finished or to be able to interfere with the program. To deactivate the child lock, keep the same buttons pressed for 3 seconds.

| | |
|--|--|
|  | When the child lock is activated, the child lock warning indicator on the screen turns on. |
|--|--|

When the child lock is active:

The drying machine runs, or in stand-by state the indicator symbols will not change upon changing the position of the program selection button.

| | |
|--|--|
|  | When the drying machine is operated and the child lock is active, if the program selection button is turned, a double beeping noise will be heard. If the child lock is deactivated before the program selection button is turned to its original place, the program will be terminated since the program selection button is displaced. |
|--|--|

6.9 Changing the program after it is started

You can change the program you selected to dry your laundry with a different program after the drying machine starts running.

- For example, Pause the program and turn the On/Off/Program Selection button to select the Extra Dry program in order to select the Extra Dry program instead of Ironing Dryness.
- Press the Start/Stand-by button to start the program.

Adding and removing clothes during stand-by

If you want to add or remove clothes to/from the drying machine after the drying program starts:

- Press the Start/Stand-by button to put the drying machine in Stand-by state. The drying operation stops.
- Open the loading door while in Stand-by state, and close the door after you remove or add laundry.
- Press the Start/Stand-by button to start the program.

| | |
|---|---|
|  | Adding laundry after the drying operation starts may cause the dried laundry inside the drying machine to mix with wet laundry and leave the laundry damp at the end of operation. Adding or removing laundry during drying may be repeated as many times as you wish. But this operation continuously interrupts the drying operation, and thus increases program duration and energy consumption. So, it is recommended to add laundry before the program starts. If a new program is selected by turning the program selection button while the drying machine is in stand-by, the running program terminates. |
|---|---|



Do not touch the inner surface of the drum while adding or removing clothes during a continuing program. The drum surface is hot.

6.10 Cancelling the program

If you want to cancel the program and terminate the drying operation for any reason after the drying machine starts running, turn the On/Off/Program Selection button after pressing the Start / Standby selection button; and the program terminates.



The inside of the drying machine shall be extremely hot when you cancel the program during machine operation, so run the refreshing program to allow it to cool down.

6.11 End of program

When the program ends, the LED's of End/Wrinkle Prevention and Fibre Filter Cleaning Warning on the program follow-up indicator turn on. Loading door can be opened and drying machine is ready for another operation.

Turn the On/Off/Program Selection button to On/Off position in order to turn off the drying machine.



If the Wrinkle Prevention mode is active and the laundry is not removed after the program is completed, the wrinkle prevention function activates for 2 hours to prevent the laundry inside the machine to get wrinkled. The program tumbles the laundry with 10-minute intervals to prevent them from wrinkling.

6.12 Odour feature

If your drying machine has odour feature, read the ProScent manual to use this feature.

6.13 SteamCure Odour and Wrinkle Removal Function

SteamCure is a refresher function that helps ironing the dry clothes that worn very little and aims to reduce airborne (cigarettes, food, etc.) odours.

It is recommended to wash the clothes to remove odours that can be absorbed by them such as perfumes, deodorants and sweat.

Do not dry products that includes sharp or hard accessories and leather.

Filling the water tank

1 blue wing in the machine performs the process of watering the laundry.

If the wing is on top, you can manually rotate the drum to the lower position and fill the water.

Before using the Steamcure program, the water in the filling container at max. Level must be filled manually into the wing.

To remove wrinkles, tap or drinking water should be used.

A few drops of water that may overflow from the wing during filling will not cause any problem.

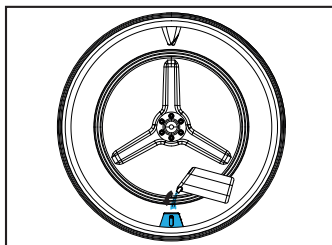
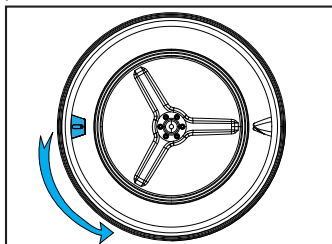



Additives or descaling agents should not be used.
Chemicals that can be dissolved with liquid chemicals and liquids should not be used.

Starting the Program

The wing should be brought to the lower position and should be filled with water up to the marked area with the filling container. The SteamCure program must be selected.

When you select the program, the screen time will appear as 10 minutes. The time program is set to the desired time by pressing the selection button and the Start/Standy-By button is pressed.

For an effective odour removal,

it is recommended to operate 1-6 pieces of dry clothing for 50 minutes.

This function does not clean clothes, it reduces the odours and wrinkles and allows you to wear them again.

7 Maintenance and cleaning



Read the "Safety Instructions" first!

7.1 Lint filters (internal and external filters) / Cleaning of the Interior Surface of the Loading Door

The hair and fibres that are separated from the laundry during drying process is collected by the Lint filter.



After each drying cycle, clean the lint filter and the inner surface of the loading door.

NOTICE

Your drying machine has 2 lint filters with one placed inside the other. Do not operate the product without the lint filters.

To clean the lint filter:

- Open the loading door.
- Hold the first part (inner filter) of the two part lint filter and remove it by pulling it upwards.

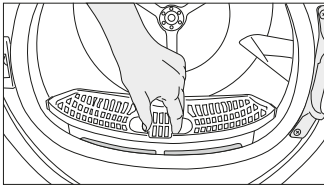

- Remove the second part (outer filter) by pulling it upwards.

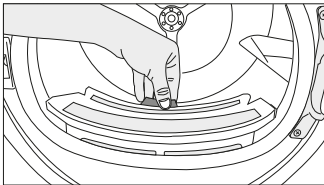

Ensure that hair, fibre and cotton balls do not fall into the slot where the filters are installed.

- Open both of the lint filters (outer and inner) and remove the fibres with your hands or with the brush on the air deflector. You can clean the hair in the filters with a vacuum cleaner.

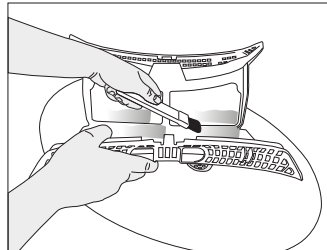
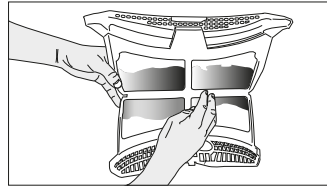
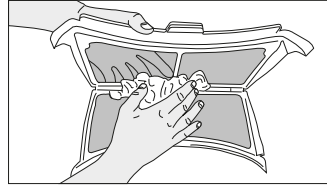

- Clean both filters under water running in reverse direction of fibre accumulation or with a soft brush. Dry the filter before placing it back.

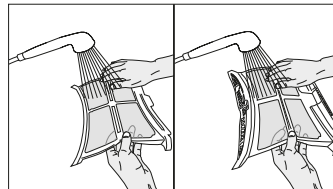



- Insert the lint filters on one another and place it back in its place.



- Clean the inner surface of the loading door and the gasket with a soft damp cloth or the brush on the air deflector.

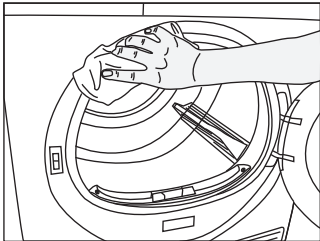
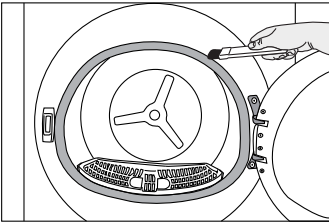
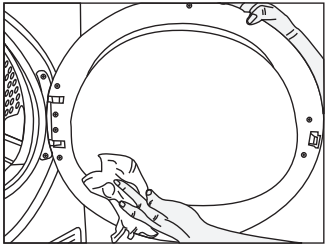

7.2 Cleaning the sensor

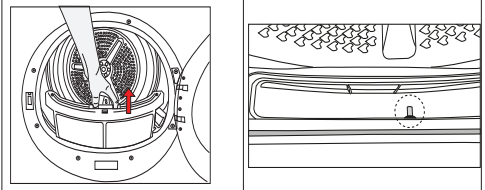

- There are temperature sensor in the dryer that detect whether the laundry is dry or not.

To clean the sensors:

- Open the loading door of the dryer.
- Remove the lint filter by pulling it up.
- Clean the sensor with your hand if any fluff accumulation on it.



Clean the metal surfaces of the sensor 4 times a year.
Do not use metal tools to clean the sensors' metal surfaces.



Due to fire and explosion hazard, do not use solutions, cleaning materials or similar tools to clean sensors.

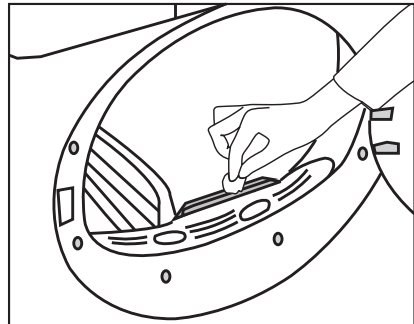

7.3 Emptying the water tank

During drying, the moisture is removed from the laundry and condensed, then the water is accumulated in the water tank. Empty the water tank after each drying session.

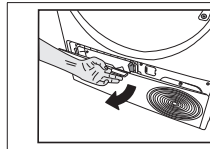

Open the toe board by pulling its button.

| | |
|--|--|
|  | <p>Condensed water is not potable water! Do not remove the water tank as a program is running!</p> |
|--|--|

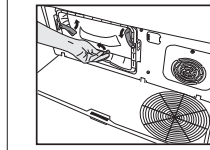

Move the latches to open the air deflector lid.

If you do not empty the water tank, during the next drying sessions the machine will stop operating due to the water tank being full and a Water Tank warning icon will blink. In this case empty the water tank and to continue drying operation, press the Start / Stand-by button.

To drain the water tank:

Pull the water tank out from its drawer carefully.

Drain the water in the tank.

Remove the water tank in the drawer or the kickplate carefully.

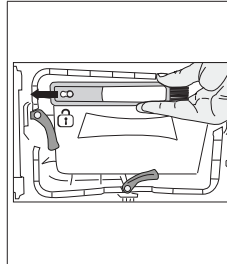

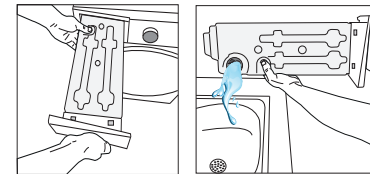

Pull the brush to the left to remove it. You can use the cleaning brush to clean filter, condensing metal surface and accumulated fibre on the door.



If fibre is accumulated in the funnel on the water tank, remove it under running water.

Place back the water tank.

| | |
|---|---|
|  | <p>The cleaning brush is inside the documentation bag. Get your brush from the documentation bag and insert it to its place on the air deflector to store it.</p> |
|---|---|

| | |
|--|--|
|  | <p>If direct discharge option is used, water tank is not required to be drained.</p> |
|--|--|

7.4 Cleaning the condenser

The hair and the fibre that are not collected by the lint filter accumulates on the metal surface of the condenser behind the air deflector. These fibres shall be cleaned regularly.

If the condenser cleaning icon blinks, check the metal surface. If there is any fibre, clean it. It must be checked at least every 6 months.

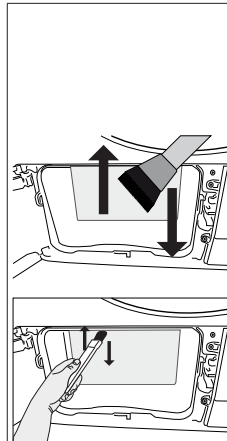

Clean the fibre on the metal surface of the condenser with damp cloth or the brush on the air deflector in up - down direction. Do not clean with left - right direction since it will damage the metal plates of the condenser.

You can use a vacuum cleaner with a brush for cleaning. If the vacuum cleaner does not have a brush, it is not recommended to be used for condenser cleaning.

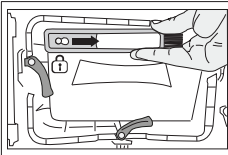

After cleaning the filter, door and the condenser, drag the brush to the right and lock it in its place.

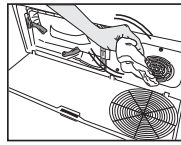

If you see fibre accumulation on the fan cover and the toe board, remove with a cloth.

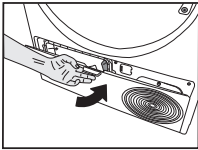

After the cleaning process is completed, place the air deflector cover to its place, move the latches to close it and close the toe board.

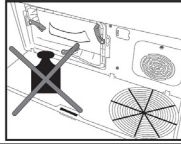

Do not have weight on the toe board when it is open.

NOTICE

Do not use abrasive materials or steel wool to clean the drum.



You can clean by hand, provided you wear protective gloves. Do not try to clean with bare hands. The condenser fins may damage your hands. Cleaning from left to right may damage the condenser fins. This may lead to drying issues.

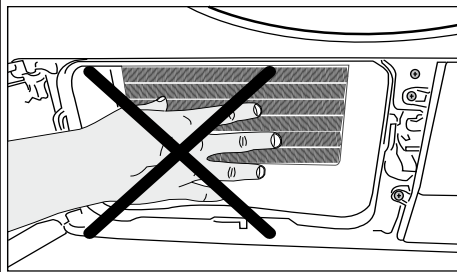

When the air deflector cover is removed, it is normal to have water at the plastic section in front of the condenser.

8 Troubleshooting

The drying operation takes too long.

Fibre filter (interior and exterior filters) pores may be clogged. >>> Wash the fibre filters with warm water and dry them

The front side of the condenser may be clogged. >>> Clean the front side of the condenser.

The ventilation grills in front of the machine may be closed. >>> Remove any object in front of the ventilation grills that blocks ventilation.

Ventilation may be insufficient due to the very small area where the machine is installed. >>> Open the door or windows to prevent the room temperature from rising too much.

If there is a humidity sensor;

Limescale may have accumulated on the humidity sensor. >>> Clean the humidity sensor.

The machine may be overloaded with laundry. >>> Do not load the drying machine excessively.

The laundry may not have been spun enough.. >>> Spin at a higher speed in the washing machine.

The laundry comes out damp after drying.

The program suitable for the laundry type may not be used. >>> Check the care labels on the laundry and select a program ideal for the kind of laundry or use additional time programs.

Fibre filter (interior and exterior filters) pores may be clogged. >>> Wash the filters with warm water and dry them
The front side of the condenser may be clogged. >>> Clean the front of the condenser.

The machine may be overloaded with laundry. >>> Do not load the drying machine excessively.

The laundry may not have been spun enough.. >>> Spin at a higher speed in the washing machine.

The dryer does not turn on, or the program cannot be started. The dryer does not turn on when set.

The power plug may not be plugged in. >>> Make sure the power plug is plugged in.

The loading door may be left open. >>> Make sure that the loading door is properly closed.

The program may not have been set or the Start / Pause button may not have been pressed. >>> Make sure that the program is set and it is not in Standby position.

Child lock may be activated. >>> Turn off the child lock.

The program was interrupted for no reason.

Loading door might not be closed properly. >>> Make sure that the loading door is properly closed.

There might be a power outage. >>> Press the Start / Standby / Cancel button to start the program.

Water tank may be full. >>> Empty the water tank.

Laundry shrunk, matted or spoiled.

The program suitable for the type of laundry may not have been used. >>> Select a program suitable for the type of laundry by checking the care labels on the laundry.

Water is flowing from the loading door.

Fibres might have gathered on the inner surfaces of the loading door and on the surfaces of the loading door gasket.
>>> Clean the inner surfaces of the loading door and the loading door gasket surfaces.

The loading door opens by itself.

The loading door might not be closed properly. >>> Push the loading door until the closing sound is heard.

The water tank warning symbol is on/flashing.

The water tank may be full. >>> Empty the water tank.

The water discharge hose might have folded. >>> If the product is connected directly to the water discharge check the hose.

The lighting inside the drying machine does not turn on (in models with lamps).

The drying machine might not have been turned on by the On/Off button. >>> Check that the drying machine is turned on.

Lamp might be broken. >>> Contact Authorized Service to replace the lamp.

Anti-Wrinkle icon or light is lit.

An anti-wrinkle program that prevents the laundry in the dryer from creasing may be activated. >>> Turn the dryer off and remove the laundry.

| |
|--|
| The fibre filter cleaning icon is lit. |
| Fibre filters (interior and exterior filters) may be unclean. >>> Wash the filters with warm water and dry them. A layer may be formed in the fibre filter pores, leading to clogging. >>> Wash the filters with warm water and dry them. A layer may be formed in the fibre filter (internal and external filters) pores that leads to clogging.<<Wash the filters with warm water and dry>> Fibre filters may not be in place. >>> Insert the interior and exterior filters into their places. Eco-friendly filter cloth may not be installed on the plastic part, and the front of the condenser may have clogged.>>>Install the eco-friendly filter to the plastic part and place it on the filter housing. Eco-friendly filters may not have been replaced, although the warning symbol is illuminated. "Replace your filter." |
| An audible warning is heard from the machine |
| Fibre filters may not be in place. >>> Insert the interior and exterior filters into their places. Filters of the machine may not have been installed.>>> Install the fibre filters (internal and external) or the environmentally-friendly filter to their housing. |
| The condenser warning icon is flashing. |
| Condenser front may be clogged with fibres. >>> Clean the front of the condenser. Fibre filters may not be place. >>> Insert the interior and exterior filters into their places. |
| The lighting inside the drying machine turns on (in models with lamps). |
| If the drying machine is plugged into the power outlet, the On/Off button is pressed, and the door is open; the light turns on. >>> Unplug the dryer or turn the On/Off switch to the off position. |
| Wi-Fi icon flashes continuously. (HomeWhiz Function models) |
| >>> The product may not be connected to the wireless network. Follow the instructions to connect to the network. The appliance which the product utilizes to connect to network may be faulty. Check it. The product may not be connected to the network due to the proximity. |
| Check the steps below if you see "F L t" on the screen. |
| The filters may be dirty. >>> Clean the inner and outer filters or replace the eco-friendly filter. In the cover area, if you are using the inner and outer dual filters. >>> Make sure that both filters are installed. If you use the eco-friendly filter feature, make sure the filter cloth is attached to the plastic part. >>>Insert the filter cloth into the plastic part if it is not inserted. The front side of the condenser may be dirty. >>> Open and check the kick zone and make sure it is clean. Check out the Maintenance and Cleaning section. |



WARNING !

If the problem persists after following the instructions in this section, contact your vendor or an Authorized Service. Never attempt to repair a malfunctioning product yourself.



NOTE!

If you experience a problem with any part of your device, you can request a replacement by

- consulting the nearest authorised service with the appliance model number
- Operating the device with non-original parts may cause malfunction of the appliance
- The manufacturer and distributor are not responsible for malfunctions caused by non-original parts

PRODUCT FICHE

Complying Commission Delegated Regulation (EU) No 392/2012

| | | |
|---|---------------|----------------------------|
| Supplier name or trademark | | BEKO |
| Model name | | BM3T38239WBB 7188303870 |
| Rated capacity (kg) | | 8.0 |
| Type of Tumble Dryer | Air Vented | - |
| | Condenser | • |
| Energy efficiency class ⁽¹⁾ | | A++ |
| Annual Energy Consumption (kWh) ⁽²⁾ | | 220,2 |
| Type of Control | Automatic | • |
| | Non-automatic | - |
| Energy consumption of the standard cotton programme at full load (kWh) | | 1,84 |
| Energy consumption of the standard cotton programme at partial load (kWh) | | 0,99 |
| Power consumption of the off-mode for the standart cotton programme at full load, P ₀ (W) | | 0,50 |
| Power consumption of the left-on mode for the standart cotton programme at full load, P _L (W) | | 1,00 |
| The duration of the left on mode (min) | | 30 |
| Standard cotton programme ⁽³⁾ | | • |
| Programme time of the standard cotton programme at full load, T _{dry} (min) | | 197 |
| Programme time of the standard cotton programme at partial load, T _{dry1/2} (min) | | 120 |
| Weighted programme time of the standard cotton programme at full and partial load (T _w) | | 153 |
| Condensation efficiency class ⁽⁴⁾ | | B |
| Average condensation efficiency of the standard cotton programme at full load, C _{dry} | | 88% |
| Average condensation efficiency of the standard cotton programme at partial load, C _{dry1/2} | | 88% |
| Weighted condensation efficiency of the standard cotton programme at full load and partial load, C ₁ | | 88% |
| Sound power level for the standard cotton programme at full load ⁽⁵⁾ | | 64 |
| Built-in | | - |

• : Yes - : No

(1) Scale from A+++ (most efficient) to D (least efficient)

(2) Energy consumption based on 160 drying cycles of the standard cotton programme at full and partial load, and the consumption of the low-power modes. Actual energy consumption per cycle will depend on how the appliance is used.

(3) "Cotton cupboard dry programme" used at full and partial load is the standard drying programme to which the information in the label and the fiche relates, that this programme is suitable for drying normal wet cotton laundry and that it is the most efficient programme in terms of energy consumption for cotton

(4) Scale from G (lest efficient) to A (most efficient)

(5) Weighted average value — L_{WA} expressed in dB(A) re 1 pW

Poštovani korisnici,

Pre upotrebe ovog proizvoda pročitajte ovo uputstvo!

Hvala što ste izabrali Beko proizvod. Želimo da postignete optimalnu efikasnost ovog visokokvalitetnog proizvoda koji je proizveden uz primenu vrhunske tehnologije. Obavezno je pročitati i potpuno razumeti ovaj vodič i dodatnu dokumentaciju pre upotrebe.

Obratite pažnju na sva upozorenja i informacije date u ovom uputstvu. Zbog toga možete zaštititi sebe i svoj proizvod od potencijalnih oštećenja.

Sačuvajte uputstvo za upotrebu. Ne odvajajte ovaj vodič od jedinice ako želite da je predate nekom drugom licu.

Simboli i napomene

Sledeći simboli se koriste u uputstvu za korisnike:



Opasnost koja može prouzrokovati smrt ili povredu



Pročitajte uputstvo za upotrebu



Važne informacije ili korisni saveti za upotrebu



Upozorenje na vruće površine



Upozorenje na strujni udar



Upozorenje na opasnost od ultraljubičastog zračenja



Upozorenje od opekotina



Ambalaža proizvoda je napravljena od sirovina koje se mogu reciklirati, u skladu sa nacionalnim zakonima o očuvanju životne sredine.



Upozorenje od požara

NAPOMENA Opasnost koja može prouzrokovati materijalnu štetu na proizvodu ili okolini



RECIKLIRANI PAPIR I
PAPIR ZA RECIKLAŽU

Ovaj proizvod je proizveden korišćenjem najnovije tehnologije u ekološki prihvatljivim uslovima.

| | |
|---|-----------|
| 1 Bezbednosna uputstva | 37 |
| 1.1 Predviđena namena..... | 37 |
| 1.2 Sigurnost dece, ugroženih osoba i kućnih ljubimaca | 37 |
| 1.3 Zaštita od električne energije | 38 |
| 1.4 Sigurnost u transportu..... | 39 |
| 1.5 Bezbednost pri ugradnji..... | 39 |
| 1.6 Bezbednost pri korišćenju | 42 |
| 1.7 Bezbednost pri održavanju i čišćenju | 44 |
| 1.8 Bezbednost osvetljenja..... | 44 |
| 2 Uputstva za zaštitu životne sredine..... | 45 |
| 2.1 Informacije o usklađenosti sa WEEE propisima i odlaganju otpada | 45 |
| 2.2 Informacije o pakovanju | 45 |
| 2.3 Standardna usaglašenost i podaci o testiranju / Izjava EU-a o usaglašenosti ... | 45 |
| 3 Vaša mašina za Sušenje | 46 |
| 3.1 Tehničke specifikacije | 46 |
| 3.2 Opšti izgled | 47 |
| 3.3 Opseg isporuke | 47 |
| 4 Instalacija..... | 48 |
| 4.1 Pravo mesto za ugradnju..... | 48 |
| 4.2 Uklanjanje bezbednosne grupe za isporuku | 48 |
| 4.3 Priključak za vodu..... | 49 |
| 4.4 Podešavanje postolja..... | 49 |
| 4.5 Pomeranje mašine za sušenje..... | 49 |
| 4.6 Upozorenje u vezi sa bukom..... | 49 |
| 4.7 Zamena sijalice..... | 49 |
| 5 Priprema..... | 50 |
| 5.1 Veš pogodan za sušenje u mašini za sušenje veša..... | 50 |
| 5.2 Veš koji nije pogodan za sušenje u mašini za sušenje veša | 50 |
| 5.3 Priprema veša za sušenje | 50 |
| 5.4 Kako se štedi energija..... | 50 |
| 5.5 Odgovarajući kapacitet punjenja | 51 |

| | |
|--|-----------|
| 6 Pokretanje proizvoda | 52 |
| 6.1 Kontrolni panel | 52 |
| 6.2 Simboli | 52 |
| 6.3 Priprema mašine za sušenje | 53 |
| 6.4 Izbor programa i tabela potrošnje | 54 |
| 6.5 Pomoćne funkcije | 56 |
| 6.6 Indikatori upozorenja | 56 |
| 6.7 Pokretanje programa | 57 |
| 6.8 Zaključavanje zbog dece | 57 |
| 6.9 Promena programa nakon što je počeo | 57 |
| 6.10 Otkazivanje programa..... | 58 |
| 6.11 Kraj programa..... | 58 |
| 6.12 Funkcija mirisa..... | 58 |
| 6.13 Funkcija uklanjanja mirisa i nabora SteamCure..... | 58 |
| 7 Održavanje i čišćenje..... | 60 |
| 7.1 Filteri za vlakna (unutrašnji i spoljni filteri) / Čišćenje unutrašnje površine vrata za punjenje..... | 60 |
| 7.2 Čišćenje senzora | 61 |
| 7.3 Pražnjenje rezervoara za vodu | 62 |
| 7.4 Čišćenje kondenzatora | 62 |
| 8 Rešavanje problema | 64 |

1 Bezbednosna uputstva

Ovaj deo sadrži uputstva o bezbednosti koja su neophodna za sprečavanje rizika od fizičkih povreda i materijalnih šteta.

- Naša kompanija ne snosi odgovornost za štetu koja može nastati ako se ova uputstva ne poštuju
- Postupke instalacije i popravke uvek mora obavljati ovlašćeni servis.
- Koristite samo originalne rezervne delove i pribor.
- Ne popravljajte i ne menjajte nijednu komponentu proizvoda ako to nije jasno naznačeno u uputstvu za upotrebu.
- Ne modifikujte proizvod.



1.1 Predviđena namena

- Uređaj je namenjen isključivo za kućnu upotrebu. On nije namenjen za komercijalnu upotrebu.
- Uređaj nije namijenjen za upotrebu na otvorenom.
- Ne instalirajte i ne koristite proizvod tamo gde postoji mogućnost smrzavanja i/ili u sredini koja može štetno delovati na spoljne elemente. Voda smrznuta u pumpi ili crevima može izazvati oštećenja.
- Proizvod se može koristiti samo za sušenje i provetravanje veša koje se pere vodom i pogodno je za korišćenje u mašini za sušenje.



1.2 Sigurnost dece, ugroženih osoba i kućnih ljubimaca

- Ovaj uređaj mogu koristiti deca od 8 godina i starija, i osobe sa ograničenim fizičkim, čulnim ili mentalnim sposobnostima, osobe koje nemaju dovoljno znanja ili iskustva ako su pod nadzorom ili su im data uputstva koja se tiču upotrebe uređaja na siguran način proizvoda i opasnosti koje uključuju. Deca ne smeju da se igraju sa uređajem. Deca ne smeju da čiste niti da održavaju uređaj bez odgovarajućeg nadzora.

- Deca mlađa od 3 godine moraju se držati dalje od proizvoda osim kada su pod nadzorom.
- Električni proizvodi su opasni za decu i kućne ljubimce. Deci i kućnim ljubimcima nije dopušteno da se igraju s proizvodom, penju se na njega ili ulaze u proizvod.
- Držite vrata proizvoda zatvorena čak i kada se ne koriste. Deca ili kućni ljubimci mogu se zaključati u proizvodu i ugušiti.
- Deca ne smeju da čiste ili održavaju aparat bez odgovarajućeg nadzora.
- Materijale za pakovanje držite dalje od dece. Opasnost od ozlede i gušenja.
- Držite sve dodatke koji se koriste s proizvodom dalje od dece.
- Pre odlaganja proizvoda prerežite kabl za napajanje i sklonite vrata za punjenje.



1.3 Zaštita od električne energije

- Proizvod ne sme biti uključen u utičnicu tokom ugradnje, održavanja, čišćenja, popravke i transporta.
- Ako je kabal za napajanje oštećen, potrebno je da zameni ovlašćeni servis kako bi se izbegao bilo kakav rizik koji se može pojaviti.
- Ne stavljajte kabal za napajanje ispod proizvoda ili na zadnju stranu proizvoda. Ne stavljajte teške predmete na kabal za napajanje. Kabel za napajanje ne smije biti savijen, priklješten i ne smije doći u dodir s bilo kojim izvorom toplote.
- Za upravljanje proizvodom ne koristite produžni kabal, višestruku priključnicu ili adapter.
- Uređaj se ne smije napajati preko eksternog uklopnog uređaja, kao što je tajmer, niti se povezati na strujno kolo koje se redovno otvara i zatvara nekom alatom.

- Utikač mora biti lako dostupan. Ako to nije moguće, na električnoj instalaciji biće dostupan mehanizam koji ispunjava zakone o električnoj energiji i koji isključuje sve priključke iz mreže (osigurač, prekidač, glavni prekidač itd.).
- Ne dodirujte utikač vlažnim rukama!
- Kad isključujete uređaj, ne držite kabal za napajanje, već utikač.



1.4 Sigurnost u transportu

- Isključite proizvod iz utičnice pre transporta, ispraznite rezervoar za vodu i, ako ih ima, uklonite priključke za odvod vode.
- Ovaj je proizvod težak, nemojte sami sa njim postupati.
- Preduzmite potrebne mere predostrožnosti za zaštitu proizvoda od pada i prevrtanja. Nemojte udariti ili ispustiti proizvod tokom transporta.
- Nemojte koristiti ekstrudirajuće delove proizvoda (poput vrata za punjenje) za pomeranje proizvoda.
- Pomerite proizvod u uspravan položaj. Ako se ne može pomeriti uspravno, transportujte ga naginjanjem udesno gledano sa prednje strane.



1.5 Bezbednost pri ugradnji

- Da biste pripremili proizvod za instalaciju, proverite informacije u korisničkom priručniku pa proverite da li su električna instalacija i odvod vode u skladu sa postavljenim zahtevima. Ako nisu pogodne za instalaciju, nazovite kvalifikovanog električara i vodoinstalatera da bi ih postavili kako je neophodno. Ove aktivnosti treba da preduzme kupac.
- Pre instaliranja proverite ima li oštećenja na proizvodu. Nemojte da instalirate uređaj ako je oštećen.
- Ne uklanjajte podesivo postolje.
- Postavite proizvod na ravnu i tvrdnu površinu i uravnotežite ga s podesivim nogama.

- Razmak između proizvoda i poda ne sme se smanjiti materijalima kao što su tepisi, komadi drveta i trake. Otvori za ventilaciju ispod osnove proizvoda ne smeju biti začepljeni tepihom.
- Proizvod treba instalirati tako da ne začepe ventilacione otvore.
- Proizvod ugradite u okruženju bez prašine sa dobrom ventilacijom.
- Ne postavljajte proizvod u neposrednoj blizini zapaljivih i eksplozivnih materijala i ne držite zapaljive i eksplozivne materijale u blizini proizvoda dok radi.
- Proizvod se ne sme postavljati na vrata, klizna vrata gde se vrata za punjenje proizvoda ne mogu potpuno otvoriti, ili iza vrata sa šarkama gde su šarke proizvoda okrenute prema šarkama vrata.
- Instalirajte proizvod tamo gde se periodično održavanje i čišćenje mogu obaviti s lakoćom.
- Postavite proizvod stražnjom površinom prema zidu (za modele koji imaju grijač).
- Nakon postavljanja proizvoda, vodite računa da zid sa zadnje strane ne dolazi u dodir sa bilo kakvim izlazima (slavina za vodu, električna utičnica itd.).
- Proizvod postavite sa razmakom od najmanje 1 cm između proizvoda i ivica nameštaja.
- Pridržavajte se pravila za priključenje provodnika navedenih u vodiču (za modele sa provodnikom).
- Izduvni vazduh se ne sme usmeravati u provodnik koji se koristi za izbacivanje dima uređaja koji troše gas ili druga goriva (za modele s kanalima s provodnikom).
- Ventilaciono crevo ne sme biti priključeno na peć za grejanje ili provodnik (za modele s provodnikom).
- Uključite proizvod u uzemljenu utičnicu zaštićenu odgovarajućim osiguračem u skladu sa navedenim tipom i strujom. Neka električar

postavi opremu za uzemljenje. Ne koristite proizvod bez uzemljenja u skladu sa lokalnim/nacionalnim propisima.

- Uključite proizvod u uzemljenu utičnicu koja odgovara vrednostima napona, struje i frekvencije navedene na tipskoj nalepnici.
- Ne stavljajte proizvod u olabavljene, slomljene, prijlave, masne utičnice ili utičnice koje su ispale iz svog ležišta ili utičnice s rizikom od dodira s vodom.
- Treba koristiti nove kompletne creva isporučenih sa proizvodom. Ne koristite stare kompletne creva. Ne stavljajte priključke na creva.
- Postavite kabl za napajanje i creva tako da ne dođe do rizika od spoticanja.
- Za upotrebu proizvoda na vrhu mašine za pranje veša, između dva proizvoda mora se koristiti otvor za pričvršćivanje. Otvor za pričvršćivanje treba da montira ovlašćeni servis.
- Kada se proizvod stavi na mašinu za pranje veša, njihova ukupna težina kada se napuni može biti oko 180 kg. Stavite proizvode na čvrst pod koji može nositi odgovarajuću količinu tereta.
- Mašina za pranje veša ne može se postavljati na mašinu za sušenje veša.

Tablica za ugradnju mašine za pranje i sušenje veša

| Tip kompleta za postavljanje mašina jedne na drugu | Veličina dubine (TD=Mašina za sušenje veša, WM: Mašina za pranje veša) |
|--|--|
| Plastika - 54/60 cm sa ili bez kaiša | 60cm TD --> WM \geq 50cm / 54cm TD --> WM>45cm |
| Plastika - 46 cm sa ili bez kaiša | 46cm TD --> WM \geq 54cm |
| Sa policom - 60cm | 60cm TD --> WM \geq 50cm |
| Sa policom - 54cm | 54cm TD --> WM>45cm |



1.6 Bezbednost pri korišćenju

- Maksimalna težina suvog veša pre pranja navedena je u odeljku „Tehničke specifikacije“.
- Ne stavljajte neoprane predmete u mašinu za sušenje veša.
- Predmeti koji su zaprljani materijalima kao što su ulja za kuhanje, aceton, alkohol, benzin, kerozin, sredstva za uklanjanje mrlja, terpentini, vosak ili sredstva za uklanjanje prašine moraju se oprati u vrućoj vodi sa većom količinom deterdženta pre sušenja u mašini za sušenje.
- Ako su hemikalije korišćene za čišćenje, mašina za sušenje se ne sme koristiti.
- Gumena pena (lateks pena), poklopci za tuširanje, vodootporni tekstil, materijali i odeća oslonjeni na gumu, jastuci sa gumenim jastučićima od pene ne smeju se sušiti u mašini za sušenje.
- Predmeti sa lakom za kosu, ostacima proizvoda za kosu ili sličnim materijalima ne smeju se sušiti u mašini za sušenje.
- Ispraznite džepove odeće i uklonite predmete poput šibica i upaljača.
- Ako se svi predmeti ne mogu brzo ukloniti i ne mogu se postaviti tamo gde toplota može da se rasprši, nemojte zaustavljati mašinu za sušenje pre nego što se ciklus sušenja završi.
- Poslednji deo ciklusa mašine za sušenje se odvija bez zagrevanja (ciklus hlađenja) kako bi se osiguralo da se predmeti drže na temperaturi koja neće štetiti predmetima.
- Omekšivači veša ili slični proizvodi moraju se koristiti u skladu sa uputstvima za omekšivač.
- Ne koristite mašinu za sušenje bez filtera za vlakna.
- Nemojte dozvoliti nakupljanje vlakana oko mašine za sušenje.
- Da bi se sprečilo povratno usisavanje gasa iz prostorije sa uređaja koji troše druga goriva, uključujući otvorenu vatru, potrebno je obezbediti odgovarajuću ventilaciju (za modele sa provodnicima).

- Proizvod ne smije raditi zajedno sa grejačima, poput grejača na gas i dimnjaka. Može doći do zapaljenja dimnjaka. (za modele s provodnikom)
- Nemojte se naslanjati ili sedeti na vratima za punjenje kada su otvorena, proizvod se može prevrnuti.
- Ne penjite se na proizvod.
- Ne stavljajte izvor plamena (sveće, cigarete, itd.) na proizvod ili u njegovoj blizini. Ne držite zapaljive/eksplozivne materijale.
- Ne dodirujte bubanj dok se okreće.
- Zadnji zid proizvoda će biti vruć tokom rada. Ne dodirujte zadnju stranu proizvoda tokom sušenja ili nakon završetka procesa sušenja. (Za modele sa grejanjem)
- Ne dodirujte unutrašnju površinu bubnja prilikom dodavanja ili uklanjanja veša tokom tekućeg programa. Površina bubnja je vruća.
- Ne pritiskajte dugmad oštrim predmetima kao što su viljuške, noževi, nokti itd.
- Ne koristite neispravan ili oštećen proizvod. Isključite proizvod (ili isključite priključeni osigurač) i pozovite ovlašćeni servis.
- Isključite proizvod kada ga ne upotrebljavate.



1.7 Bezbednost pri održavanju i čišćenju

- Ne perite proizvod prskanjem ili sipanjem vode na njega! Za čišćenje proizvoda nemojte koristiti čistač pod pritiskom, parni čistač, crevo ili pištolj pod pritiskom.
- Za čišćenje proizvoda ne koristite oštre ili abrazivne alate.
- Ne koristite materijale kao što su sredstva za čišćenje u domaćinstvu, tečnosti za pranje, deterdženti, plin, benzin, alkohol, vosak itd. za čišćenje proizvoda.
- Filter za vlakna treba redovno čistiti. Nakon svakog ciklusa sušenja, očistite filter vlakna i unutrašnju površinu vrata za punjenje.
- Očistite usisivačem dlačice nakupljene na lopaticama isparivača koji se nalazi iza fioke filtera. Možete čistiti rukom pod uslovom da nosite zaštitne rukavice. Ne pokušavajte da čistite golim rukama. Možete povrediti ruku na krilcima isparivača. (za proizvode sa toplotnom pumpom)
- Zbog opasnosti od požara i eksplozije, za čišćenje senzora ne koristite otopine, materijale za čišćenje, čeličnu vunu ili slične materijale i alate.
- Očistite provodnik. (za modele s provodnikom)
- Ne pijte kondenzovanu vodu.



1.8 Bezbednost osvetljenja

- Obratite se ovlašćenom servisu kada budete morali da zamenite LED/ sijalicu za osvetljenje (za proizvode sa osvetljenjem).

2 Uputstva za zaštitu životne sredine

2.1 Informacije o usklađenosti sa WEEE propisima i odlaganju otpada



Ovaj proizvod ne sadrži opasne i zabranjene materijale naznačene u „Direktivi o kontroli otpadne električne i elektronske opreme“ koju je objavilo Ministarstvo zaštite životne sredine i prostornog planiranja Republike Turske. Usklađen je sa WEEE propisima. Ovaj proizvod je proizveden sa recikliranim visokokvalitetnim delovima i materijalima za višekratnu upotrebu. Stoga ne odlažite ovaj proizvod sa drugim kućnim otpadom na kraju njegovog veka trajanja. Odnosite ga u sabirni centar za električnu i elektronsku opremu. O ovim sabirnim centrima se možete raspitati kod lokalne uprave. Možete pomoći u zaštiti životne sredine i prirodnih resursa tako što ćete iskorišćene proizvode odneti na reciklažu.



Takođe R290 je zapaljivo rashladno sredstvo. Stoga pazite da sistem i cevi ne budu oštećeni tokom rada i transporta.

Čuvajte proizvod od izvora toplote, inače se može zapaliti ako se ošteti.

Ne odlažite proizvod tako što ćete ga spaljivati.

2.2 Informacije o pakovanju

Ambalaža proizvoda je napravljena od materijala koji mogu da se recikliraju, u skladu sa nacionalnim propisima o zaštiti životne sredine. Ambalažu ne odložite sa kućnim otpadom ili drugim vrstama otpada već je odložite u sabirne centre za ambalažu koje su navele lokalne vlasti.

2.3 Standardna usaglašenost i podaci o testiranju / Izjava EU-a o usaglašenosti



Faze razvoja, proizvodnje i prodaje ovog proizvoda odvijaju se u skladu sa sigurnosnim pravilima navedenim u svim srodnim uputstvima Evropske unije.

3 Vaša mašina za Sušenje

3.1 Tehničke specifikacije

SB

| | |
|-----------------------|------------------------------|
| Visina (min. / maks.) | 84,6 cm / 86,6 cm* |
| Širina | 59,8 cm |
| Dubina | 54,5 cm |
| Kapacitet (maks.) | 8 kg** |
| Neto težina (± %10) | 42 kg |
| Napon | Pogledajte tipsku pločicu*** |
| Označeni ulaz snage | |
| Šifra modela | |

* Min. visina: Visina sa zavidanim podesivim postoljem.

Maks. visina: Visina sa podesivim postoljem odvidanim do maksimalne visine.

** Težina suvog veša pre pranja.

*** Pločica sa podacima nalazi se ispod vrata mašine za sušenje veša.



U cilju povećanja kvaliteta mašine za sušenje, može doći do izmena tehničkih specifikacija bez prethodnog obaveštenja.

Slike u ovom uputstvu su šematske i možda se neće u potpunosti poklapati s uređajem.





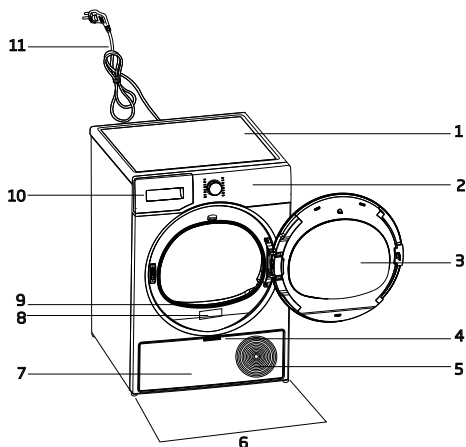



Vrednosti date na mašini za sušenje ili pratećoj dokumentaciji su laboratorijska očitavanja u skladu sa odgovarajućim standardima. Ove vrednosti mogu da se razlikuju u zavisnosti od korišćenja i ambijentalnih uslova.

3.2 Opšti izgled

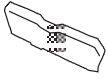

1. Gornja ploča
2. Kontrolna tabla
3. Vrata za punjenje
4. Drška donje table za nogice
5. Ventilacione rešetke
6. Podesive nožice
7. Donja tabla za nogice
8. Nazivna pločica
9. Filter za vlakna
10. Ladica rezervoara za vodu
11. Kabl za napajanje

3.3 Opseg isporuke

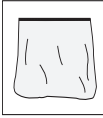
| | | | |
|---|---|---|----------------------------|
|  | 1. Crevo za ispuštanje vode* |  | 6. Otvor za punjenje vode* |
|  | 2. Rezervni sunder za fioku sa filterom* |  | 7. Čista voda* |
|  | 3. Uputstvo za upotrebu |  | 8. Grupa kapsula za miris* |
|  | 4. Korpa za sušenje |  | 9. Četka* |
|  | 5. Uputstvo za upotrebu korpe za sušenje* |  | 10. Krpa za filtriranje* |

4 Instalacija



Prvo pročitajte odeljak „Bezbednosna uputstva“!

Pre nego što se obratite najbližem ovlašćenom servisu za postavljanje mašine za sušenje, pogledajte informacije u korisničkom uputstvu i uverite se da električne i vodovodne instalacije zadovoljavaju zahteve. Ako ne postoje, pozovite električara i vodoinstalatera da bi ih postavili po potrebi.



Kupac je odgovoran za pripremu lokacije na kojoj će biti postavljena mašina za sušenje, kao i za pripremu instalacije za napajanje i odvod otpadnih voda.



Pre instaliranja proverite ima li oštećenja na mašini za sušenje. Ako je mašina oštećena, nemojte je ugrađivati. Oštećeni uređaji dovode do rizika po vašu bezbednost. Sačekajte 12 sati pre uvođenja mašine za sušenje u rad.

NAPOMENA

Proizvod sadrži rashladno sredstvo i ako se proizvodom rukuje odmah nakon transporta, može se oštetiti. Nakon svakog pomeranja proizvoda, ostavite ga da miruje 12 sati.

4.1 Pravo mesto za ugradnju

- Mašinu za sušenje postavite na ravnu i stabilnu površinu.
- Mašina za sušenje veša je teška. Nemojte je sami pomerati.
- Mašinu za sušenje koristite u okruženju bez prašine sa dobrom ventilacijom.
- Razmak između mašine za sušenje i poda ne sme se smanjiti materijalima kao što su tepisi, komadi drveta i trake.
- Ne blokirajte ventilacione rešetke mašine za sušenje veša.
- U blizini okruženja za postavljanje mašine za sušenje ne smeju biti vrata koja se mogu zaključati, klizna vrata ili vrata sa šarkama koja mogu blokirati otvaranje vrata za punjenje.

- Nakon postavljanja mašine za sušenje priključci moraju ostati stabilni. Nakon postavljanja mašine za sušenje, vodite računa da zid sa zadnje strane ne dolazi u dodir sa bilo kakvim izlazima (slavina za vodu, električna utičnica itd.).
- Mašinu za sušenje postavite sa razmakom od najmanje 1 cm između proizvoda i ivica nameštaja.
- Vaša mašina za sušenje je pogodna za rad na temperaturama od +5°C do +35°C. Ako mašina radi van ovog temperaturnog opsega, rad vaše mašine za sušenje može biti ugrožen a mašina oštećena.
- Mašina za sušenje ne sme da se postavlja stražnjom stranom uz zid.



Ne stavljajte mašinu za sušenje preko njenog kabla za napajanje.

- *** Zanemarite sledeće upozorenje ako sistem vašeg proizvoda ne sadrži R290.**



Mašina za sušenje sadrži rashladno sredstvo R290.* R290 je ekološko, ali zapaljivo rashladno sredstvo.* Obezbedite da dovod vazduha na mašini za sušenje bude otvoren i dobro provetren.* Udaljite potencijalne izvore plamena od mašine za sušenje.*

4.2 Uklanjanje bezbednosne grupe za isporuku

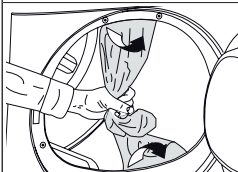

Uklonite bezbednosnu grupu za isporuku pre prve upotrebe proizvoda.

NAPOMENA

Ne ostavljajte dodatke ili bilo koji deo bezbednosne grupe za transport u bubnju.

4.3 Priključak za vodu

Umesto da povremeno ispuštate vodu akumuliranu u rezervoaru za vodu, možete je ispustiti preko creva za ispuštanje vode isporučeno sa mašinom za sušenje.

Povezivanje otvora za ispuštanje vode

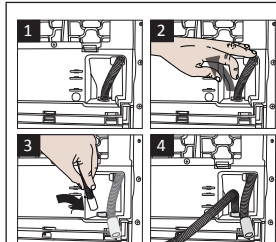

1-2 Skinite crevo iza mašine za sušenje ručno povlačeći ga sa mesta gde je pričvršćeno. Nemojte koristiti alat za uklanjanje creva.

3 Umetnite jedan kraj creva za ispuštanje vode isporučenog sa mašinom za sušenje na mesto gde ste uklonili crevo na mašini za sušenje.

4 Drugi kraj creva za ispuštanje vode pričvrstite na direktno odvođenje otpadne vode ili u umivaonik.

NAPOMENA

Crevo za ispuštanje vode mora biti pričvršćeno na maksimalnu visinu od 80 cm. Vodite računa da crevo za ispuštanje vode nije savijeno, prekinuto ili pritisnuto između odvoda i mašine za sušenje. Crevo mora biti priključeno tako da se ne odvaja od mesta na kojem je. Voda koja curi može izazvati oštećenja. Nemojte produžavati crevo za odvod vode. Proverite da li voda teče odgovarajućim tokom. Odvodni vod ne sme biti zatvoren ili začepljen.



Ako je uz proizvod isporučen paket dodatne opreme, pogledajte detaljna uputstva.

4.4 Podešavanje postolja

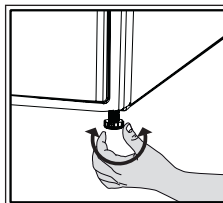

Dok se mašina za sušenje ne postavi ravno i stavljivo, podešavajte nogice okrećući ih levo i desno.

4.5 Pomeranje mašine za sušenje

- Potpuno ispuštite vodu iz mašine za sušenje.
- Ako je proizvod povezan sa direktnim odvodom, uklonite priključke creva.



Preporučujemo da mašinu za sušenje pomerate u uspravnom položaju. U suprotnom, mašinu za sušenje nagnite udesno gledano sa prednje strane i pomerite. Sačekajte 12 sati pre korišćenja mašine za sušenje.

4.6 Upozorenje u vezi sa bukom

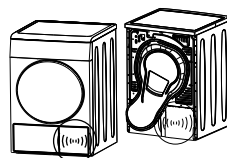

Dok je mašina uključena, kompresora može s vremena na vreme ispustiti zvukove povezane sa metalom, što je normalno.



Kada je mašina uključena, akumulirana voda se pumpa u rezervoar za vodu. Normalno je da tokom tog rada čujete zvukove pumpanja iz uređaja.

4.7 Zamena sijalice

Ako vaša mašina za sušenje ima lampu za osvetljenje bubnja;

Obratite se ovlašćenom servisu da zamenite sijalicu/LED lampicu koja se koristi za osvetljenje vaše mašine za sušenje veša. Sijalica iz ove mašine nije pogodna za kućno osvetljenje. Predviđena upotreba ove lampice je da obezbedi bezbedno stavljanje veša u mašinu za sušenje. Lampice koje se koriste u ovoj mašini otporne su na teške fizičke uslove, kao što su temperature preko 50 °C.

5 Priprema



Prvo pročitajte odeljak „Bezbednosna uputstva“!

5.1 Veš pogodan za sušenje u mašini za sušenje veša

NAPOMENA

Veš koji nije pogodan za sušenje u mašini za sušenje veša može oštetiti mašinu, a i veš se može oštetiti tokom sušenja. Pratite uputstva na etiketama na vešu za sušenje. Sušite samo veš s natpisom „Pogodno za mašinu za sušenje veša“ koji se napisan na nalepnicama.



Ne sušiti u mašini za sušenje veša

5.2 Veš koji nije pogodan za sušenje u mašini za sušenje veša

NAPOMENA

Donji veš sa metalnim nosačima ne sme se sušiti u mašini za sušenje. Ako se ovi metalni nosači olabave i otkinu sa odeće, to može oštetiti mašinu. Delikatni vez, tekstil od pamuka i svile, odeća napravljena od osetljivog i vrednog tekstila, odeća od poliestera i zavese od tila ne smeju se sušiti u mašini za sušenje.

5.3 Priprema veša za sušenje

NAPOMENA

Predmeti kao što su kovanice, metalni delovi, igle, ekseri, šarafi, kamenje itd. mogu oštetiti grupu bubnjeva proizvoda ili uzrokovati nepravilnosti u radu. Stoga proverite svo rublje koje želite staviti u mašinu.

Osušite s naličja veš s metalnim dodacima poput patenta. Zatvorite patente, kuke i kopče, zakopčajte dugmad na navlakama, zavežite tekstilne pojaseve i pojaseve kecelja.

5.4 Kako se štedi energija

- Prilikom pranja veša koristite opciju najvećeg mogućeg ceđenja. Tako možete smanjiti period sušenja i smanjiti potrošnju energije. Sortirajte veš prema vrsti i debljini. Sušite iste vrste veša zajedno. Na primer, kuhinjski peškiri i stolnjaci brže se suše od kupatilskih peškira.
- Sledite preporuke u korisničkom priručniku za odabir programa.
- Tokom sušenja nemojte otvarati vrata za punjenje, osim ako je to potrebno. Ako morate otvoriti vrata za punjenje, nemojte ih držati otvorenim predugo.
- Nemojte dodavati mokro rublje dok mašina za sušenje radi.
- Očistite filter za vlakna pre i posle svake sesije sušenja.
- Kod modela s kondenzacijom, kondenzator čistite najmanje jednom mesečno ili nakon svakih 30 sušenja.
- Vodute računa da su filteri čisti. Detaljnije se informišite u odeljku Održavanje i čišćenje.
- Kod modela s provodnikom pridržavajte se pravila za priključenje provodnika navedenih u uputstvima i očistite provodnik.
- Tokom sušenja, pravilno provetrajajte okruženje u kome se nalazi mašina za sušenje.
- Na modelima sa toplotnom pumpom, proveravajte kondenzator najmanje svakih šest meseci i čistite ga ako je prljav.

- Ako koristite ekološki filter, ne morate da čistite filter nakon svakog ciklusa. Kada na ekranu svetli ikona ekološke prihvatljivosti, promenite platno filtera.

5.5 Odgovarajući kapacitet punjenja

NAPOMENA

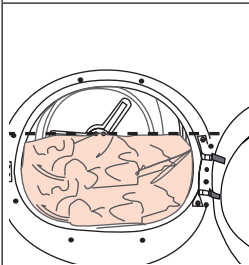

Ako veš u proizvodu premašuje maksimalnu nosivost, možda neće raditi kako je predviđeno i može izazvati materijalnu štetu ili oštetiti proizvod. Za svaki program sledite maksimalnu nosivost.

Težine u nastavku su date kao primeri.

| Veš | Cca. težina (u g)* | Veš | Cca. težina (u g)* |
|--|--------------------|-------------------|--------------------|
| Pamučna posteljina (veličina za bračni krevet) | 1500 | Pamučna haljina | 500 |
| Posteljina (veličina za pojedinačni krevet) | 1000 | Haljina | 350 |
| Čaršav (veličina za bračni krevet) | 500 | Teksas | 700 |
| Čaršav (veličina za pojedinačni krevet) | 350 | maramice (10 kom) | 100 |
| Veliki stolnjak | 700 | Majic | 125 |
| Mali stolnjak | 250 | Bluza | 150 |
| Salveta | 100 | Pamučna majica | 300 |
| Peškir za tuširanje | 700 | Košulje | 200 |
| Peškir za ruke | 350 | | |

*Težina suvog veša pre pranja.

6 Pokretanje proizvoda

6.1 Kontrolni panel

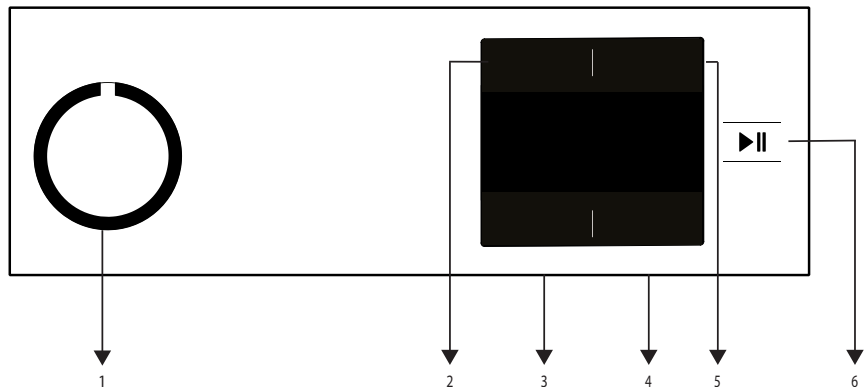

1. Dugme za uključivanje/isključivanje/biranje programa.
2. Dugme za izbor niske temperature.
3. Dugme za izbor nivoa suvoće i prevencije nabora.
4. Vreme završetka i dugme za izbor dečje brave.
5. Program tajmera i dugme za izbor zvučnog upozorenja.
6. Dugme za pokretanje/pripravnost.

6.2 Simboli

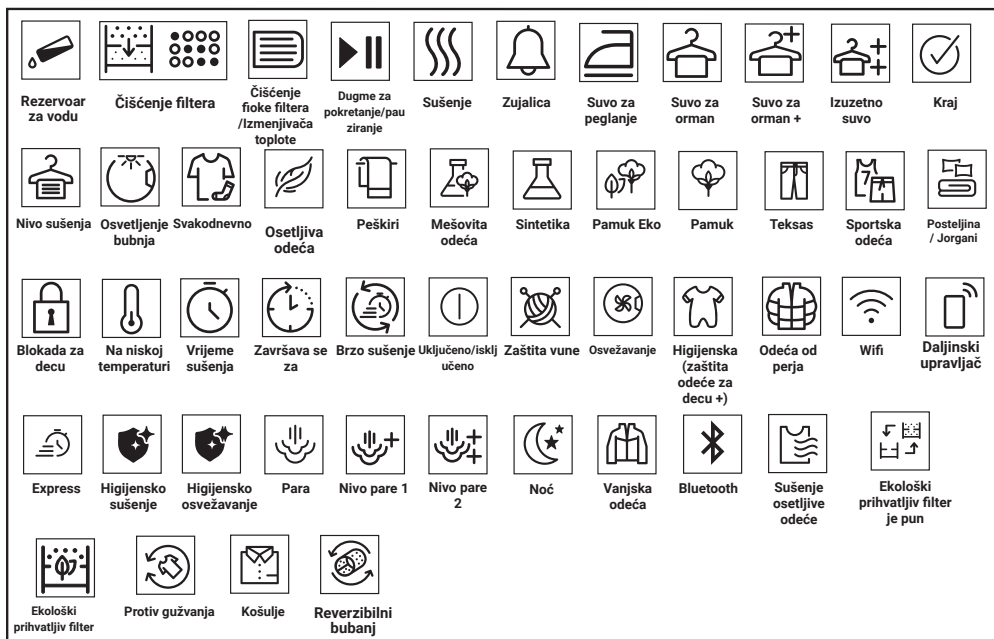

6.3 Priprema mašine za sušenje

- Priključite mašinu za sušenje.
- Otvorite vrata za punjenje mašine.
- Stavite veš za sušenje u mašinu tako da se ne zaglavi.
- Gurnite i zatvorite vrata za punjenje mašine.

NAPOMENA

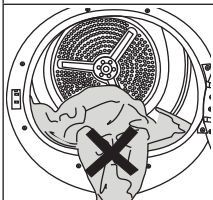

Uverite se da veš nije zaglavio vrata za punjenje mašine. Ne zatvarajte vrata za punjenje na silu.

- Kada izaberete željeni program pomoću dugmeta za uključivanje/isključivanje/biranje programa, mašina će se uključiti.





Izbor programa pomoću dugmeta za uključivanje/isključivanje/biranje programa ne znači da je program počeo. Pritisnite dugme Pokretanje/pripravnost da biste pokrenuli program.

6.4 Izbor programa i tabela potrošnje

| SB | | | | |
|--|---|----------------|---|-----------------------|
| Programi | Opis programa | Kapacitet (kg) | Brzina centrifuge u mašini za pranje veša (o/min) | Vreme sušenja (minut) |
| Pamuk | Na ovom ciklusu možete sušiti pamučne tkanine otporne na toplotu. Treba izabrati podešavanje sušenja koje odgovara debljini predmeta koji se suše i željenom nivou suvoće. | 8 | 1000 | 200 |
| Pamuk Eko | Jednoslojne ležerne pamučne tkanine suše se na najekonomičniji mogući način. | 8 | 1000 | 197 |
| Pamuk Spremno za peglanje | Jednoslojne ležerne pamučne tkanine suše se tako da ostanu malo vlažne i da budu spremne za peglanje. | 8 | 1000 | 160 |
| Sintetika | Na ovom ciklusu možete sušiti sve vaše sintetičke tkanine. Treba izabrati podešavanje sušenja koja odgovara željenom nivou suvoće. | 4 | 800 | 75 |
| Pomesati(Dnevni) | Ovaj program koristite za sušenje neobojenog sintetičkog i pamučnog veša zajedno. Ovim programom se može sušiti sportska odeća i odeća za fitness. | 4 | 1000 | 125 |
| Peškir | Sušenje peškira kao što su kuhinjski peškir, peškir za kupanje i peškir za ruke. | 5 | 1000 | 170 |
| Odeća za spoljašnje uslove/ sportska odeća (Goretex) | Koristite ga za sušenje odeće od sintetičkih, pamučnih ili mešanih tkanina ili vodonepropusnih proizvoda, kao što su funkcionalna jakna, kišni mantil itd. Pre sušenja, odeću okrenite naopako. | 2 | 1000 | 130 |
| Osveži | On provetriva samo 10-160 minuta bez davanja toplog vazduha. Ovim programom možete provetriti pamučnu i lanenu odeću koja je dugo bila zatvorena da biste uklonili njen miris. | - | - | - |
| Vremenski programi / Steamcure | Možete da birate između vremenskih programa od 10 do 160 minuta da biste postigli željeni nivo sušenja na niskoj temperaturi. Na ovom programu rad mašine za sušenje traje tokom postavljenog vremena, nezavisno od suvoće veša. SteamCure é um função de refrescamento que tem a finalidade de ajudar a passar a ferro a roupa interior seca e a reduzir os odores em suspensão no ar (cigarro, alimentos, etc.) | - | - | - |
| Osetljivo | Možete sušiti osetljivo rublje ili rublje sa simbolom za ručno pranje (svilene bluze, tanak donji veš itd.) na niskoj temperaturi ovog programa. | 2 | 1200 | 45 |
| Set pokrivača za jorgan | Osušite 1 komplet pamučnog ili sintetičkog popluna tako što ćete zatvoriti dugme / patent zatvarač. | 2 | 1000 | 121 |

| | | | | |
|--------------------|---|-----|------|-----|
| Perje | Okrenite odeću kao što su donji kaputi, jakne naopako da se osuši. | - | 800 | 119 |
| Džinsy | U ovom programu možete sušiti pantalone, suknje, košulje i jakne od teksasa. | 4 | 1200 | 130 |
| Košulja | On suši košulje na delikatniji način i uzrokuje manje gužvanja i lakše peglanje. | 1,5 | 1200 | 50 |
| Higijensko sušenje | To je program kojim možete isušiti oprane proizvode kojima želite da pružite dodatnu higijenu. Omogućava visok nivo higijene tkaninama pomoću toplotnog efekta. | 5 | 800 | 185 |
| Ekspresno | Koristiti ovaj program kako biste imali 2 stvari spremne za peglanje. | 0,5 | 1200 | 30 |

Vrednosti potrošnje energije

| Programi | Kapacitet (kg) | Brzina centrifuge u mašini za pranje veša (o/min) | Približna količina preostale vlage | Potrošnja energije kWh |
|---|--|---|------------------------------------|------------------------|
| Pamuk Eko* | 8 | 1000 | 60% | 1,84 |
| Pamuk Spretno za peglanje | 8 | 1000 | 60% | 1,60 |
| Sintetika Spretno za nošenje | 4 | 800 | 40% | 0,75 |
|  | „Program Pamuk Eko“, koji se koristi za puno i delimično punjenje, je standardni program za sušenje na koji se odnose informacije na etiketi i u dokumentaciji, i prikladan je za sušenje normalno vlažnog pamučnog veša, a predstavlja najefikasniji program u pogledu potrošnje energije za sušenje pamučnog veša. | | | |
|  | „Ako redovno sušite maksimalnu količinu pamuka od 8 kg, predlažemo da povežete crevo za odvod da biste sprečili da se mašina za sušenje veša zbog pražnjenja posude zaustavi na pola ciklusa“ (pogledajte odeljak „Povezivanje na odvod“) | | | |

* : Energetska nalepnica za standardni program EN 61121 Vrednosti u tabeli se utvrđuju u skladu sa standardom EN 61121. Vrednosti potrošnje mogu da variraju od vrednosti u tabeli u zavisnosti od vrste veša, brzine ceđenja, uslova okoline i nivoa napona.



Allergy UK zaštitni je naziv Britanske fondacije za alergije. Pečat odobrenja je napravljen tako da ukazuje osobama koje traže savet da proizvod značajno smanjuje količinu alergena u okruženju u kome su prisutne osobe s alergijama ili da proizvod ograničava/smanjuje/eliminira alergene. Svrha je osiguravanje dokaza da su proizvodi naučno testirani ili pregledani da osiguraju merljive rezultate.

6.5 Pomoćne funkcije Nivo sušenja

Dugme za nivo sušenja koristi se za podešavanje željenog nivoa sušenja. Trajanje programa se može promeniti u zavisnosti od izbora.



Ovu funkciju možete da aktivirate isključivo pre početka programa.

Sprečavanje gužvanja

Funkciju prevencije bora možete uključiti ili isključiti pritiskom na dugme za vreme završetka na 3 sekunde. Ako ne izvadite veš odmah po završetku programa, možete koristiti funkciju za sprečavanje gužvanja da sprečite gužvanje veša.

Zvučno upozorenje

Mašina za sušenje pravi zvuk upozorenja kada se program završi. Pritisnite dugme „Zvučni signal upozorenja“ ako ne želite zvučno upozorenje. Kada pritisnete dugme za zvučno upozorenje, lampica se gasi i ne čuje se kada je program završen.



Možete da izaberete ovu funkciju pre ili nakon početka programa.

Na niskoj temperaturi

Ovu funkciju možete da aktivirate isključivo pre početka programa. Ovu funkciju možete aktivirati ako želite da sušite veš na nižoj temperaturi. Trajanje programa će biti duže nakon što se aktivira.

Vreme završetka

Možete da odložite vreme završetka programa do 24 časa pomoću funkcije Vreme završetka.

1. Otvorite vrata za punjenje i stavite veš.
2. Izaberite program sušenja.
3. Pritisnite dugme za izbor završetka i podesite kašnjenje koje želite. LED lampica vremena završetka se uključuje. (Kada se dugme pritisne i drži, vreme završetka se produžava na non-stop).
4. Pritisnite dugme Pokretanje/pripravnost. Odbrojanje za vreme završetka počinje. Znak „:“ na sredini prikazanog vremena odlaganja treperi.



Možete dodati ili ukloniti veš na kraju. Prikazano vreme je zbir normalnog vremena sušenja i vremena završetka. LED lampica vremena završetka će se isključiti na kraju odbrojanja, sušenje počinje i LED lampica za sušenje će zasvetleti.

Promena vremena završetka

Ukoliko želite da promenite trajanje tokom odbrojanja:

Paузirajte program i aktivirajte dugme za uključivanje/isključivanje/biranje programa i otkazite program. Izaberite željeni program i ponovite izbor vremena završetka.

Otkazivanje funkcije vremena završetka

Ako želite da otkazete odbrojanje vremena završetka i odmah pokrenete program:

Paузirajte program i aktivirajte dugme za uključivanje/isključivanje/biranje programa i otkazite program. Izaberite željeni program i pritisnite dugme Pokretanje/Pauziranje.

6.6 Indikatori upozorenja



Indikatori upozorenja mogu da variraju u zavisnosti od modela mašine za sušenje veša.

Čišćenje filtera

Kada se program završi, uključice se indikator upozorenja za čišćenje filtera.

Rezervoar za vodu

Ako se rezervoar za vodu napuni dok je program u toku, indikator za upozorenje počinje da treperi i mašina ide u režim pripravnosti. U tom slučaju ispraznite vodu iz rezervoara i pokrenite program pritiskom na dugme Pokretanje/pripravnost. Indikator upozorenja se isključuje i program nastavlja sa radom.

Čišćenje fiok filtera/izmenjivača toplote

Simbol upozorenja povremeno treperi da bi podsetio da se fioka filtera mora očistiti.

6.7 Pokretanje programa

Pritisnite dugme Pokretanje/pripravnost da biste pokrenuli program.

Indikator Pokretanje/pripravnost i Sušenje svetleće da naznače da je program počeo.

6.8 Zaključavanje zbog dece

Mašina ima zaštitu od dece koja sprečava da tok programa bude prekinut kada se stisnu dugmad u toku programa. Kada se aktivira zaključavanje zbog dece, sva dugmad na panelu se onemogućavaju osim dugmeta za uključivanje/isključivanje/biranje programa.

Pritisnite dugme za vreme završetka 3 sekunde da biste aktivirali zaključavanje zbog dece.

Zaključavanje zbog dece treba da se deaktivira da biste mogli da započnete novi program nakon što je tekući program završen ili da biste mogli da promenite program. Za deaktivaciju zaštite od dece, zadržite istu dugmad 3 sekunde.



Kada se zaštita od dece aktivira, na ekranu se uključuje indikator upozorenja na zaštitu od dece.

Kada je zaštita od dece aktivna:

Kada mašina za sušenje veša radi ili je u stanju pripravnosti, simboli indikatora se neće promeniti uprkos promeni položaja dugmeta za izbor programa.



Kad mašina za sušenje radi i blokada za decu je aktivirana, ako je tipka za odabir programa okrenuta, čuće se dvostruki zvučni signal. Ako je blokada za decu deaktivirana pre nego što je dugme za izbor programa okrenuto u prvobitni položaj, program će se prekinuti jer je dugme za izbor programa pomereno.

6.9 Promena programa nakon što je počeo

Možete promeniti izabrani program za sušenje veša i izabrati drugi program nakon što je mašina za sušenje veša počela da radi

- Na primer, pauzirajte program i okrenite dugme za uključivanje/isključivanje/biranje programa na odabir programa Extra sušenje da biste izabrali program Extra sušenje umesto Sušenje do nivoa za peganje.
- Pritisnite dugme Pokretanje/pripravnost da biste pokrenuli program.

Dodavanje i uklanjanje veša tokom pripravnosti

Ako želite da dodate ili uklonite veš nakon početka programa sušenja:

- Pritisnite dugme Pokretanje/pripravnost da prebacite mašinu za sušenje veša u režim pripravnosti. Operacija sušenja se zaustavlja.
- Otvorite vrata za punjenje mašine dok je u stanju mirovanja i zatvorite vrata nakon dodavanja ili vađenja veša.
- Pritisnite dugme Pokretanje/pripravnost da biste pokrenuli program.

| | |
|--|--|
|  | <p>Dodavanje veša posle početka operacije sušenja može izazvati mešanje osušenog i mokrog veša unutar mašine za sušenje i veš može ostati vlažan nakon postupka.</p> <p>Dodavanje ili uklanjanje veša tokom sušenja možete ponoviti koliko god puta želite. Ali ta operacija neprekidno prekida operaciju sušenja, što produžava trajanje programa i povećava potrošnju energije. Dakle, preporučljivo je da dodate veš pre početka programa. Ako izaberete novi program okretanjem dugmeta za izbor programa dok je mašina za sušenje veša u režimu pripravnosti, trenutni program će se prekinuti.</p> |
|--|--|

| | |
|--|---|
|  | <p>Ne dodirujte unutrašnju površinu bubnja prilikom dodavanja ili uklanjanja veša tokom tekućeg programa. Površina bubnja je vruća.</p> |
|--|---|

6.10 Otkazivanje programa

Ako želite da otkazete program i da prekinete operaciju sušenja iz bilo kog razloga nakon što mašina za sušenje veša počne sa radom, pauzirajte program i pritisnite dugme za uključivanje/isključivanje/biranje programa; program će biti prekinut.

| | |
|--|---|
|  | <p>Unutrašnjost mašine za sušenje veša može biti veoma vruća kada otkazete program, stoga osvežite program da bi se ohladila.</p> |
|--|---|

6.11 Kraj programa

Kad se program završi, LED lampice za završetak/sprečavanje gužvanja i čišćenja filtera za vlakna upale se na indikator praćenja programa. Vrata za punjenje se mogu otvoriti i mašina za sušenje postaje spremna za drugu operaciju.

Okrenite dugme za uključivanje/isključivanje/biranje programa u položaj Uključeno/Isključeno da biste isključili mašinu za sušenje veša.

| | |
|---|--|
|  | <p>Ako aktivirate sprečavanje gužvanja i ne uklonite veš nakon završetka programa, funkcija za sprečavanje gužvanja veša se aktivira na 2 sata radi sprečavanja gužvanja veša unutar mašine. Program okreće veš u intervalima od 10 minuta radi sprečavanja gužvanja veša.</p> |
|---|--|

6.12 Funkcija mirisa

Ako vaša mašina za sušenje ima funkciju mirisa, pročitajte priručnik za ProScent da biste je koristili.

6.13 Funkcija uklanjanja mirisa i nabora SteamCure

SteamCure je funkcija osvežavanja koja pomaže u ispravljanju nabora na suvoj odeći koja se vrlo malo nosila, a za cilj ima smanjenje mirisa koji se prenose vazduhom (miris cigarete, hrane itd.).

Preporučuje se da odeću operete kako bi se uklonili mirisi koje ona može upiti, poput parfema, dezodoransa i znoja.

Ne sušite proizvode koji na sebi imaju oštre ili tvrde dodatke i kožu.

Punjenje rezervoara za vodu

1 plavo krilo u mašini izvodi postupak dodavanja vode u veš.

Ako je krilo na vrhu, možete ručno rotirati bubanj u donji položaj i napuniti vodu.

Pre upotrebe programa Steamcure, voda u posudi za punjenje na maks. nivou mora se ručno popuniti u krilo.

Da biste uklonili nabore, treba koristiti vodu iz slavine ili vodu za piće.

Ako se nekoliko kapi vode tokom punjenja prelje sa krila, to neće predstavljati nikakav problem.

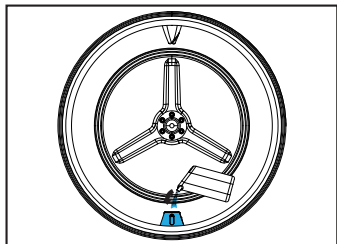
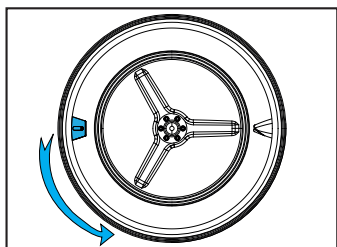

Ne bi trebalo koristiti dodatna sredstva ili sredstva za uklanjanje kamenca.

Ne bi trebalo koristiti hemikalije koje se mogu rastvoriti tečnim hemikalijama i tečnostima.

Pokretanje programa

Krilo treba staviti u donji položaj i vodom ga napuniti do nivoa označenog na posudi za punjenje. Mora biti izabran program SteamCure.

Kada odaberete program, vreme ekrana će se prikazati kao 10 minuta.

7 Održavanje i čišćenje



Prvo pročitajte odeljak „Bezbednosna uputstva“!

7.1 Filteri za vlakna (unutrašnji i spoljni filteri) / Čišćenje unutrašnje površine vrata za punjenje

Dlake i vlakna koji se izdvajaju iz veša tokom procesa sušenja prikupljaju se u filteru vlakana.



Nakon svakog ciklusa sušenja, očistite filter vlakna i unutrašnju površinu vrata za punjenje.

NAPOMENA

Vaša mašina za sušenje ima 2 filtera za vlakna, jedan postavljen u drugi. Nemojte uključivati uređaj bez filtera za vlakna

Za čišćenje filtera:

- Otvorite vrata za punjenje mašine.
- Držite prvi deo (unutrašnji filter) dvodelnog filtera za vlakna i uklonite ga tako što ćete ga povući nagore.

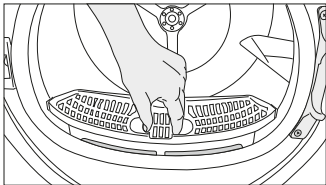

- Uklonite drugi deo (spoljašnji filter) povlačenjem nagore.

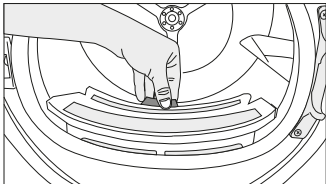

Postarajte se da dlake, vlakna i pamučne loptice ne padnu u kućište gde se filteri instaliraju.

- Otvorite oba filtera za vlakna (spoljašnji i unutrašnji) i uklonite vlakna rukama ili četkom na usmerivaču vazduha. Dlačice sa filtera možete očistiti usisivačem.

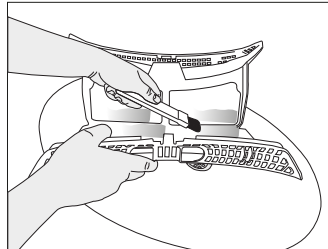
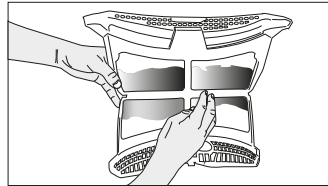
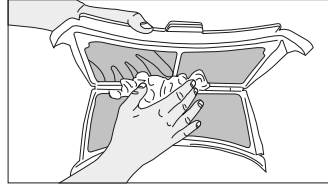

- Očistite oba filtera pod vodom koja teče u smeru suprotnom od nakupljanja vlakana ili korišćenjem meke četke. Osušite filter pre vraćanja.

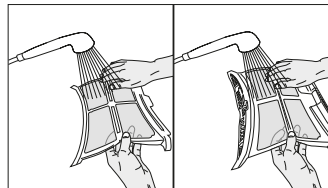

7.2 Čišćenje senzora

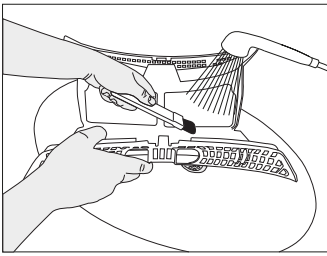

- Ubacite filtre za vlakna jeda na drugi i vratite ih na mesto.

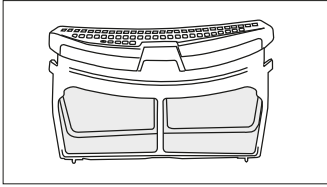

- Očistite unutrašnju površinu vrata za punjenje i zaptivku mekom vlažnom krpom ili četkom na usmerivaču vazduha.

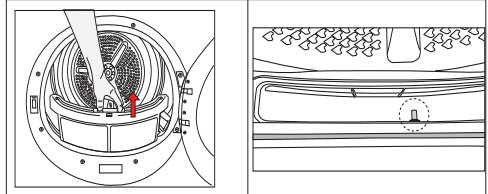
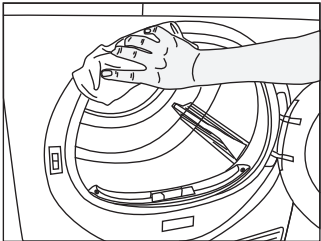
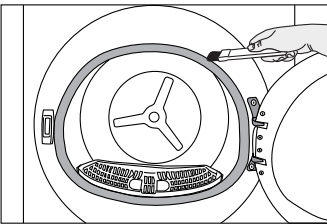
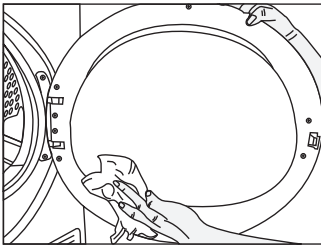

- Mašina za sušenje ima senzore vlažnosti koji detektuju da li je veš suv.
- Za čišćenje senzora:
- Otvorite vrata za punjenje mašine za sušenje.
- Ako je mašina vruća zbog sušenja, sačekajte da se ohladi.
- Očistite metalne površine senzora mekom krpom navlaženom sirćetom a zatim ih osušite.



Čistite metalne površine senzora 4 puta godišnje.
Ne koristite metalne alate za čišćenje metalnih površina senzora.



Zbog opasnosti od požara i eksplozije, nemojte koristiti rastvore, materijale za čišćenje ili slične alate za čišćenje senzora.

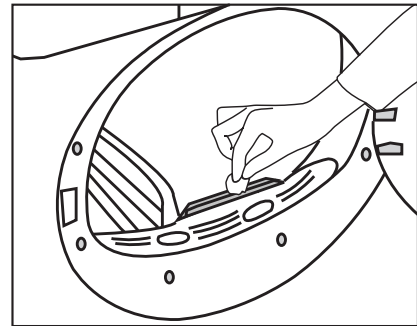

7.3 Pražnjenje rezervoara za vodu

Tokom sušenja, vlaga se uklanja iz veša i kondenzuje, zatim se voda akumulira u rezervoaru za vodu. Ispraznite rezervoar za vodu nakon svakog ciklusa sušenja.



Kondenzovana voda nije voda za piće!
Nikada ne uklanjajte rezervoar za vodu dok je program u toku!

Ako ne ispraznite rezervoar za vodu, tokom sledećih sušenja mašina će prestati da radi zbog punjenja rezervoara za vodu i ikona upozorenja za rezervoar za vodu će treperiti. U tom slučaju ispraznite rezervoar za vodu i za nastavak sušenja pritisnite dugme za Početak/ Pripravnost.

Za pražnjenje rezervoara za vodu:

Pažljivo izvucite rezervoar za vodu iz fiok.

Pažljivo izvadite rezervoar za vodu iz fiok ili posude.

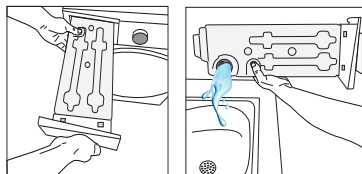

Ako se vlakna nakupe u levku na rezervoaru za vodu, uklonite ih pod mlazom vode.

Vratite rezervoar za vodu u njegovu poziciju.



Ako se koristi opcija direktnog pražnjenja, rezervoar za vodu nije potrebno isprazniti.

7.4 Čišćenje kondenzatora

Dlačice i vlakna koja se ne sakupljaju na filteru za vlakna nakupljaju se na metalnoj površini kondenzatora iza usmerivača vazduha. Ova vlakna treba redovno čistiti.

Ako ikona čišćenja kondenzatora trepće, proverite metalnu površinu. Ako ima vlakana, očistite ih. Mora se proveravati najmanje jednom u svaka 6 meseca.

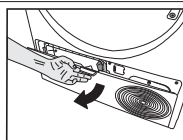

Otvorite donju ploču tako što ćete je pritisnuti.

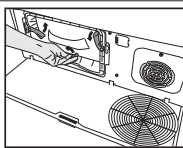

Pomerite reze da biste otvorili poklopac usmerivača vazduha.

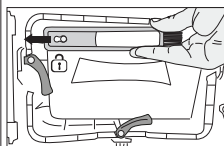

Gurnite četku na levu stranu i uklonite je. Četkom za čišćenje možete očistiti filter, kondenzovanu vodu sa metalne površine i nakupljena vlakna na vratima.



Četka za čišćenje se nalazi u vrećici s dokumentacijom. Izvadite četku iz vrećice za dokumentaciju i umetnite je na mesto na usmerivaču vazduha da biste je uskladištili.

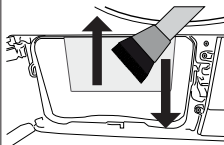

Očistite vlakna sa metalne površine kondenzatora vlažnom krpom ili četkom na usmerivaču vazduha u smeru gore-dole. Nemojte čistiti u smeru levo-desno jer ćete oštetiti metalne ploče kondenzatora. Za čišćenje možete koristiti usisivač sa četkom. Ako usisivač nema četku, ne preporučuje se upotreba usisivača za čišćenje kondenzatora.

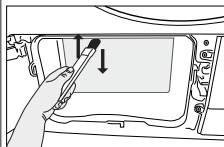

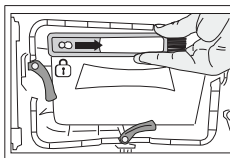

Nakon čišćenja filtera, vrata i kondenzatora, povucite četku udesno i uklopite je na njenoj poziciji.

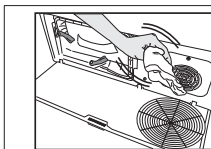

Ako vidite nakupljanje vlakana na poklopcu ventilatora i donjoj ploči, uklonite ih krpom.

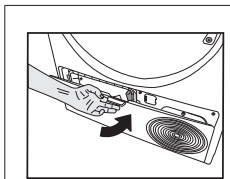

Nakon što se proces čišćenja završi, stavite usmerivač vazduha na mesto, pomerite bravice da ih zatvorite i zatvorite donju ploču.

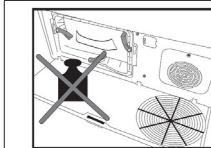

Nemojte opterećivati donju ploču kada je otvorena.

NAPOMENA

Za čišćenje bubnja nemojte koristiti abrazivne materijale ili čeličnu vunu.



Možete čistiti rukom pod uslovom da nosite zaštitne rukavice. Ne pokušavajte da čistite golim rukama. Možete povrediti ruku na krilcima kondenzatora. Čišćenjem pokretima s leva nadesno možete oštetiti krilca kondenzatora. To može da dovede do problema u vezi sa isparavanjem.

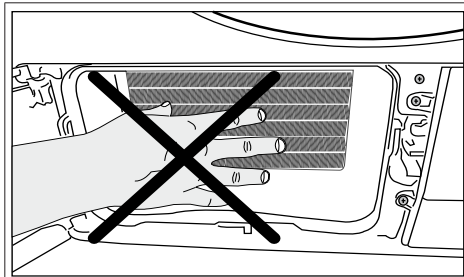

Kada se ukloni poklopac usmerivača vazduha, normalno je da vode bude na plastičnom delu ispred kondenzatora.

8 Rešavanje problema

Radnja sušenja predugo traje.

Pore filtera za vlakna (unutrašnji i spoljašnji filter) su možda začepljene. >>> Operite filtere za vlakna toplom vodom i osušite ih.

Prednja strana kondenzatora je možda začepljena. >>> Očistite prednju stranu kondenzatora.

Ventilacione rešetke na prednjoj strani mašine su možda zatvorene. >>> Uklonite sve predmete ispred ventilacionih rešetki koje blokiraju vazduh.

Ventilacija može biti neodgovarajuća zbog toga što je prostor u kome je mašina postavljena premali. >>> Otvorite vrata i prozore da biste sprečili visoko povećanje temperature u prostoriji.

Ako postoji senzor za vlažnost vazduha.

Sloj kamenca se možda nakupio na senzoru vlažnosti. >>> Očistite senzor za vlažnost.

Možda je ubačena prekomerna količina veša. >>> Ne stavljajte prekomernu količinu veša mašinu za sušenje.

Veš možda nije pravilno isceden. >>> Uključite ceđenje u veš mašini većom brzinom.

Odeća je vlažna nakon sušenja.

Možda je korišćen program koji nije pogodan za unešenu vrstu veša. >>> Proverite nalepnice za održavanje na odeći i odaberite program pogodan za vrstu odeće ili vremenske programe koristite kao dodatne.

Pore filtera za vlakna (unutrašnji i spoljašnji filter) su možda začepljene. >>> Operite filtere toplom vodom i osušite ih.

Prednja strana kondenzatora je možda začepljena. >>> Očistite prednju stranu kondenzatora.

Možda je ubačena prekomerna količina veša. >>> Ne stavljajte prekomernu količinu veša mašinu za sušenje.

Veš možda nije pravilno isceden. >>> Uključite ceđenje u veš mašini većom brzinom.

Mašina za sušenje se ne uključuje ili program ne može da se pokrene. Mašina za sušenje ne radi nakon što se konfigurise.

Utikač za napajanje je možda iskopčan. >>> Postarajte se da utikač za napajanje bude uključen.

Možda su otvorena vrata za punjenje mašine. >>> Proverite da li su vrata za punjenje mašine pravilno zatvorena.

Možda nije podešen program ili možda nije pritisnuto dugme za Početak / Otkazivanje. >>> Proverite da li je program podešen i da li se ne nalazi u položaju Pauza.

Možda je aktivirana funkcija za zaključavanje zbog dece. >>> Isključite funkciju zaključavanja zbog dece.

Program je prekinut prevremeno bez razloga.

Vrata za ubacivanje veša su možda u potpunosti zatvorena. >>> Proverite da li su vrata za punjenje mašine pravilno zatvorena.

Možda je nestala struja. >>> Pritisnite dugme za pokretanje/pauziranje/otkazivanje da biste pokrenuli program.

Možda je rezervoar za vodu pun. >>> Ispraznite rezervoar za vodu.

Odeća se skupila, učvrstnula ili iskvarela.

Možda je korišćen program koji nije prikladan za predmetnu vrstu veša. >>> Proverite nalepnice za održavanje na odeći i odaberite program pogodan za odeću.

Voda kaplje iz vrata za punjenje.

Možda su se nakupila vlakna na unutrašnjim stranama vrata za punjenje i na površinama zaptivke vrata za punjenje. >>> Očistite unutrašnju površinu vrata za punjenje i površinu zaptivke vrata za punjenje.

Vrata za punjenje mašine se sama otvaraju.

Vrata za ubacivanje veša su možda u potpunosti zatvorena. >>> Gurnite vrata za punjenje sve dok se ne čuje zvuk zatvaranja.

Simbol upozorenja na rezervoar za vodu svetli/treperi.

Možda je rezervoar za vodu pun. >>> Ispraznite rezervoar za vodu.

Crevo za odvod vode je možda presavijeno. >>> Ako je proizvod direktno povezan na odvod za vodu, proverite crevo za ispuštanje vode.

| | |
|---|--|
| Osvetljenje u mašini za sušenje veša se ne uključuje. (kod modela sa svetlom) | |
| Mašina za sušenje možda nije uključena korišćenjem dugmeta za uključivanje/isključivanje. >>> Proverite da li je mašina za sušenje uključena. Možda je svetlo pregorelo. >>> Obratite se ovlašćenom servisu da biste zamenili lampu. | |
| Svetli ikona ili svetlo za sprečavanje nabora. | |
| Režim ciklusa protiv gužvanja koji sprečava da se veš u mašini za sušenje pogužva je možda aktiviran. >>> Isključite mašinu za sušenje i izvadite veš. | |
| Ikonica za čišćenje filtera za vlakna svetli. | |
| Filter za vlakna (unutrašnji i spoljašnji filter) možda nije čist. >>> Operite filtere toplom vodom i osušite ih. Na porama filtera za vlakna može se formati sloj koji dovodi do začepljenja. >>> Operite filtere toplom vodom i osušite ih. Možda je došlo do sloja koji može izazvati začepljenje pora na vlaknima (unutrašnji i spoljašnji filteri). << Operite i osušite filtere mlakom vodom >> Filteri za vlakna možda nisu ubačeni. >>> Ubacite unutrašnji i spoljašnji filter na svoja mesta. Filterska tkanina koja ne šteti životnoj sredini ne sme se postavljati na plastični deo, a prednji deo kondenzatora je možda začepljen. >>> Instalirajte ekološki prihvatljiv filter na plastični deo i postavite ga na kućište filtera. Ekološki prihvatljiv filter možda nije zamenjen iako simbol upozorenja svetli. „Zamenite filter.“ | |
| Zvučno upozorenje se čuje iz mašine | |
| Filteri za vlakna možda nisu ubačeni. >>> Ubacite unutrašnji i spoljašnji filter na svoja mesta. Filteri mašine možda nisu postavljeni.>>> Postavite platna na filterima (unutrašnje i spoljašnje) ili ekološki prihvatljiv filter u njihovo kućište. | |
| Ikonica upozorenja za kondenzator treperi. | |
| Prednja strana kondenzatora je možda začepljena vlaknima. >>> Očistite prednju stranu kondenzatora. Filteri za vlakna možda nisu ubačeni. >>> Ubacite unutrašnji i spoljašnji filter na svoja mesta. | |
| Osvetljenje u mašini za sušenje se uključuje. (kod modela sa svetlom) | |
| Ako je mašina za sušenje priključena u strujnu utičnicu, ako se pritisne dugme za uključivanje/isključivanje i vrata se otvore, osvetljenje se uključuje. >>> Izvadite utikač mašine za sušenje i postavite dugme za uključivanje/isključivanje u isključeni položaj. | |
| Ikonica za Wi-Fi neprestano treperi. (za modele sa funkcijom HomeWhiz) | |
| >>> Proizvod možda nije povezan sa bežičnom mrežom. Pratite uputstva za povezivanje na mrežu. Uređaj koji proizvod koristi za povezivanje na mrežu možda je neispravan. Proverite. Proizvod se možda ne povezuje na mrežu zbog faktora udaljenosti.. | |
| Ako vidite poruku „F L t“ na ekranu, sledite dole navedene korake. | |
| Filteri su možda prljavi. Očistite unutrašnje i spoljne filtere ili zamenite ekološki prihvatljiv filter. Ako koristite dvostruki filter, kao unutrašnji i spoljni filter, na površini poklopca, obavezno proverite da li su postavljena oba filtera. Ako koristite funkciju ekološkog filtera, obavezno proverite da platno na filteru bude postavljeno na plastični deo. Umetnite platno na filteru na plastični deo ako nije postavljen. Prednji deo kondenzatora je možda prljav. Otvorite i pregledajte područje donje ploče i proverite da li je čisto. Pogledajte odeljak Održavanje i čišćenje. | |



Ako problem i dalje postoji nakon što ste slijedili upute u ovom poglavlju, obratite se prodavcu ili ovlašćenom servisu. Nikada nemojte sami da pokušavate da popravite proizvod.



Ako se suočite sa bilo kojim problemom sa svojim uređajem, možete zatražiti zamenu tako što ćete se obratiti najbližem ovlašćenom servisu sa brojem modela uređaja.

TEHNIČKI LIST PROIZVODA

U skladu sa Uredbom koju je izdala komisija (EU) br.: 392/2012

| | | |
|--|--------------|----------------------------|
| Naziv dobavljača ili robna marka | | BEKO |
| Naziv modela | | BM3T38239WBB 7188303870 |
| Ocena kapaciteta (kg) | | 8.0 |
| Tip mašine za sušenje veša | Izdovna | - |
| | Kondenzator | • |
| Klasa energetske efikasnosti ⁽¹⁾ | | A++ |
| Godišnja potrošnja energije (kWh) ⁽²⁾ | | 220,2 |
| Vid kontrole | Automatski | • |
| | Neautomatski | - |
| Potrošnja energije kod standardnog programa za pamuk pri maksimalnom punjenju (kWh) | | 1,84 |
| Potrošnja energije kod standardnog programa za pamuk pri delimičnom punjenju (kWh) | | 0,99 |
| Potrošnja energije u režimu isključeno za standardni program za pamuk pri maksimalnom punjenju, P ₀ (W) | | 0,50 |
| Potrošnja energije u režimu uključeno za standardni program za pamuk pri maksimalnom punjenju, P ₁ (W) | | 1,00 |
| Trajanje režima uključeno (min) | | 30 |
| Standardni program za pamuk ⁽³⁾ | | • |
| Vreme za standardni program za pamuk pri maksimalnom punjenju, T _{day} (min) | | 197 |
| Vreme za standardni program za pamuk pri delimičnom punjenju, T _{day/2} (min) | | 120 |
| Procenjeno programsko vreme za standardni program za pamuk pri maksimalnom i delimičnom punjenju (T ₁) | | 153 |
| Klasa efikasnosti kondenzacije ⁽⁴⁾ | | B |
| Prosečna efikasnost kondenzacije kod standardnog programa za pamuk pri delimičnom punjenju C _{day} | | 88% |
| Prosečna efikasnost kondenzacije kod standardnog programa za pamuk pri delimičnom punjenju, C _{day/2} | | 88% |
| Procenjena efikasnost kondenzacije kod standardnog programa za pamuk pri maksimalnom i delimičnom punjenju, C ₁ | | 88% |
| Nivo zvučne snage standardnog programa za pamuk pri maksimalnom punjenju ⁽⁵⁾ | | 64 |
| Ugrađeno | | - |

• : Da - : Ne

(1) Skala od A+++ (najefikasnije) do D (najmanje efikasno)

(2) Potrošnja energije na osnovu 160 okretaja sušenja za standardni program za pamuk pri maksimalnom i delimičnom punjenju i potrošnja u režimu smanjene potrošnje. Stvarna potrošnja energije po okretaju zavisice od toga kako se aparat koristi.

(3) „Program za sušenje pamuka bez peglanja“ korišćen za maksimalno i delimično punjenje, standardni je program za sušenje na koji se odnose podaci na nalepnici i tehničkom listu, što znači da je ovaj program pogodan za sušenje normalno vlažnog pamučnog veša i najefikasniji je program za pamuk u pogledu potrošnje energije.

(4) Skala od G (najmanje efikasno) do A (najefikasnije)

(5) Procenjena prosečna vrednost —L_{WA} izražena u dB(A) u odnosu na 1 pW

