

8 7 6 5 4 3 2 1

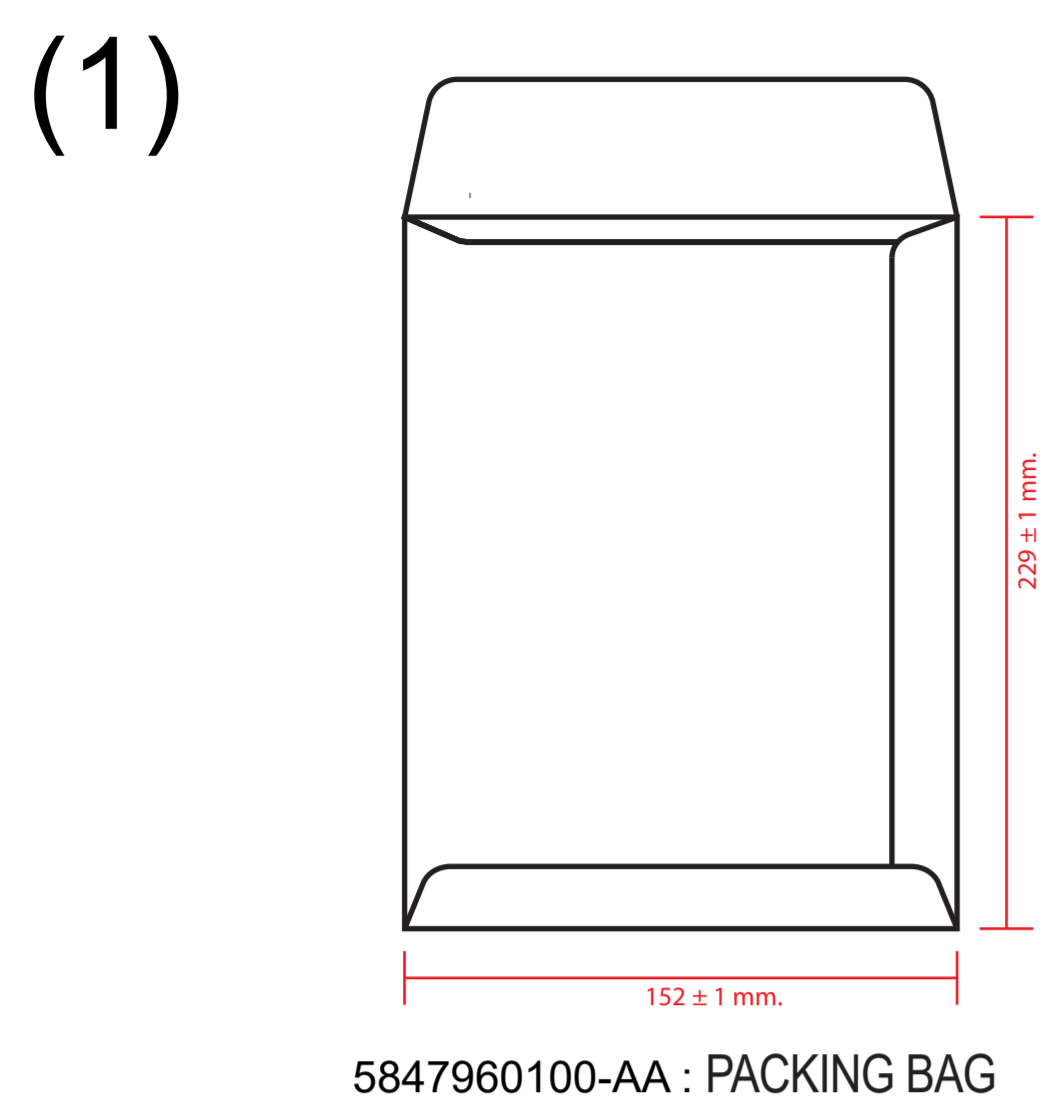

5847960100-AA : PACKING BAG

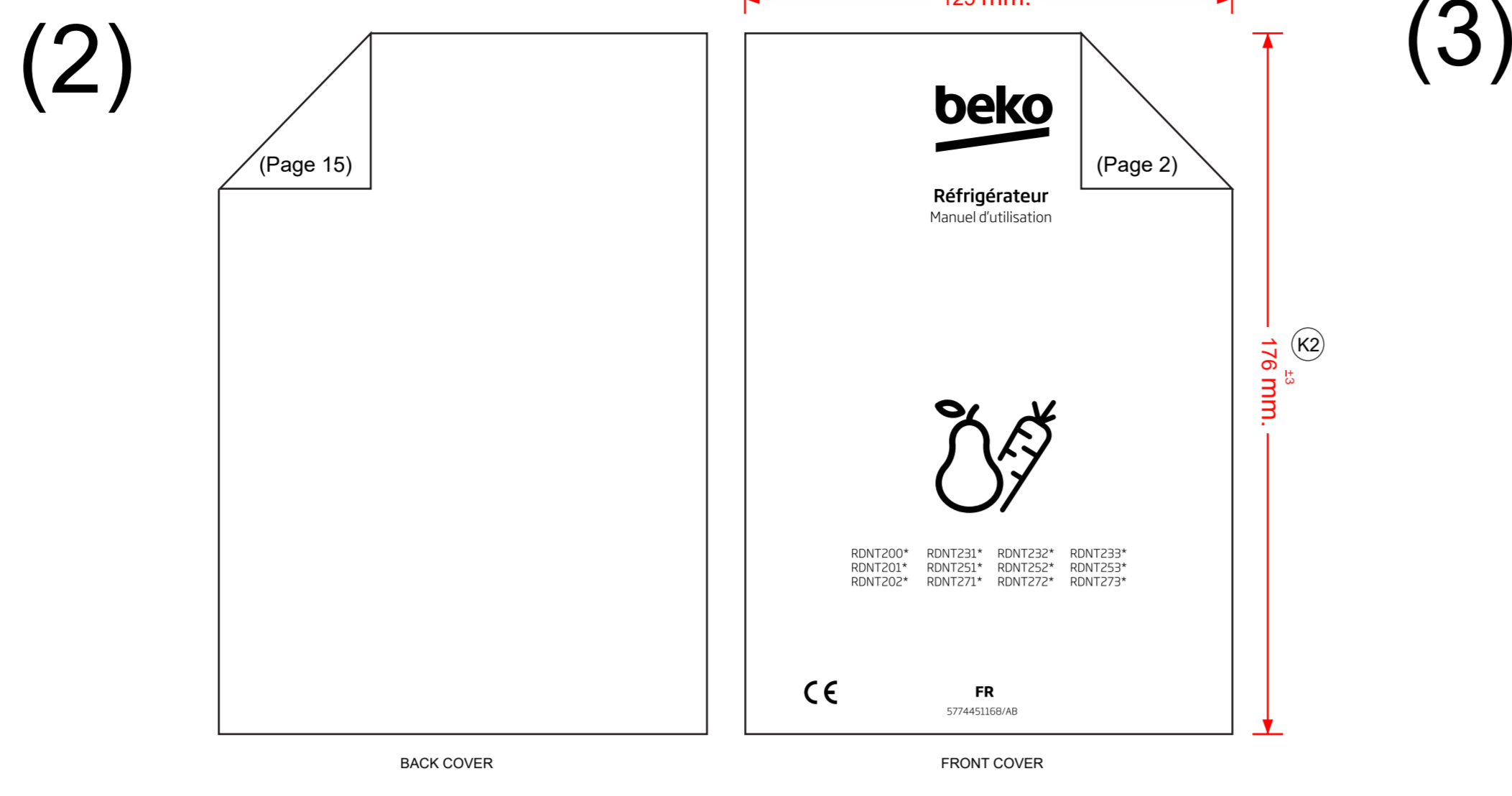

5774451168-AB : USER MANUAL

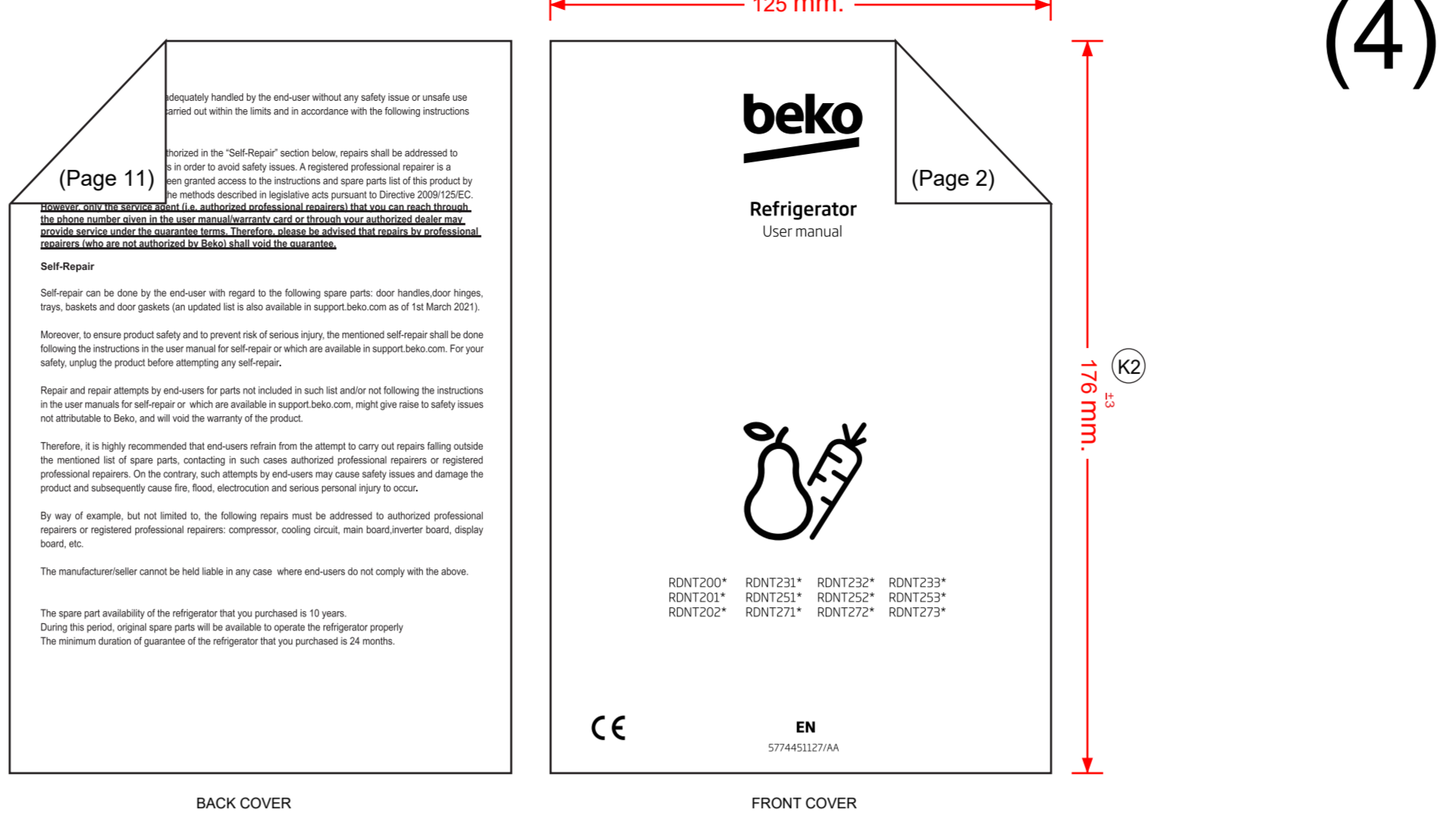

5774451127-AA : USER MANUAL

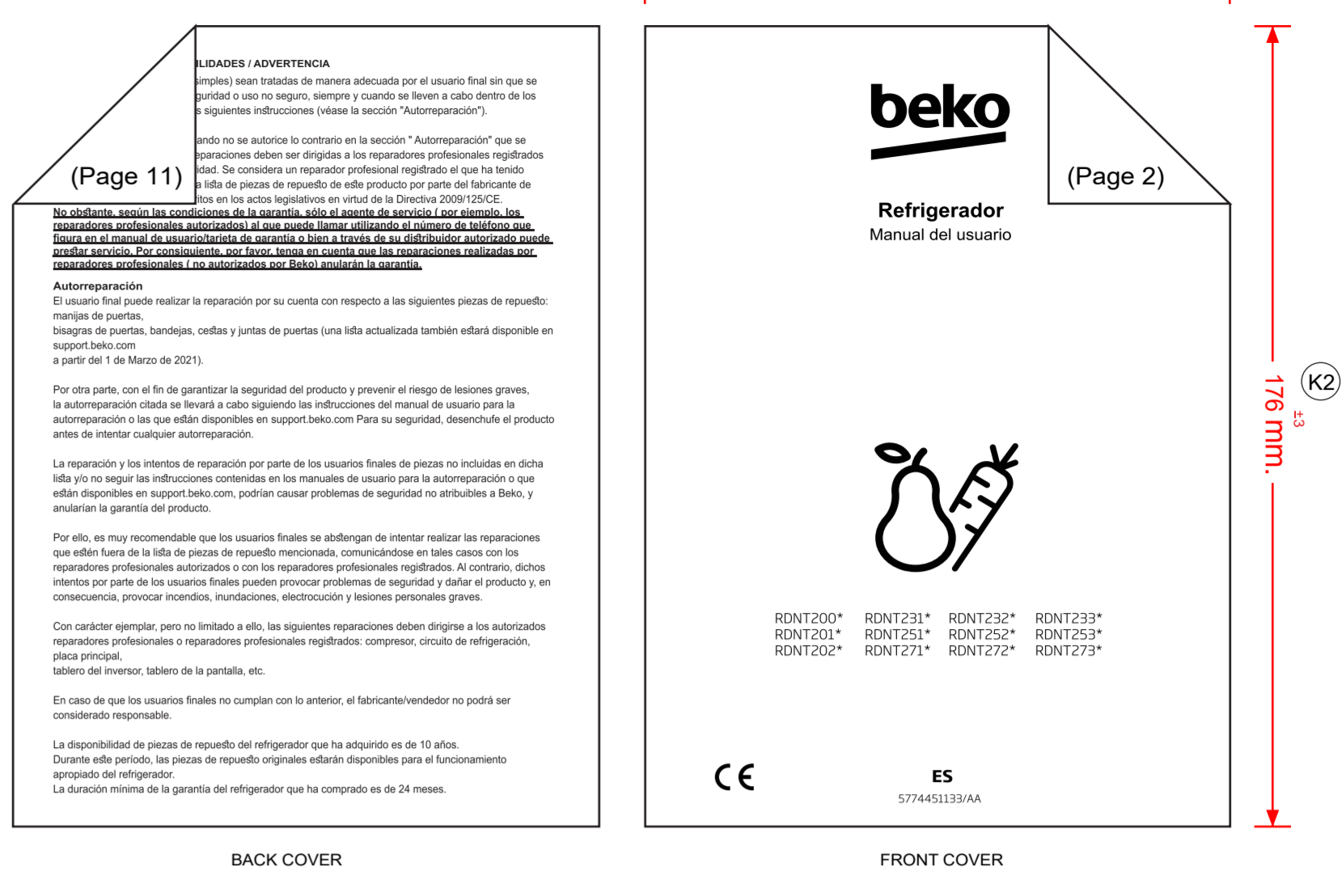

5774451133-AA : USER MANUAL

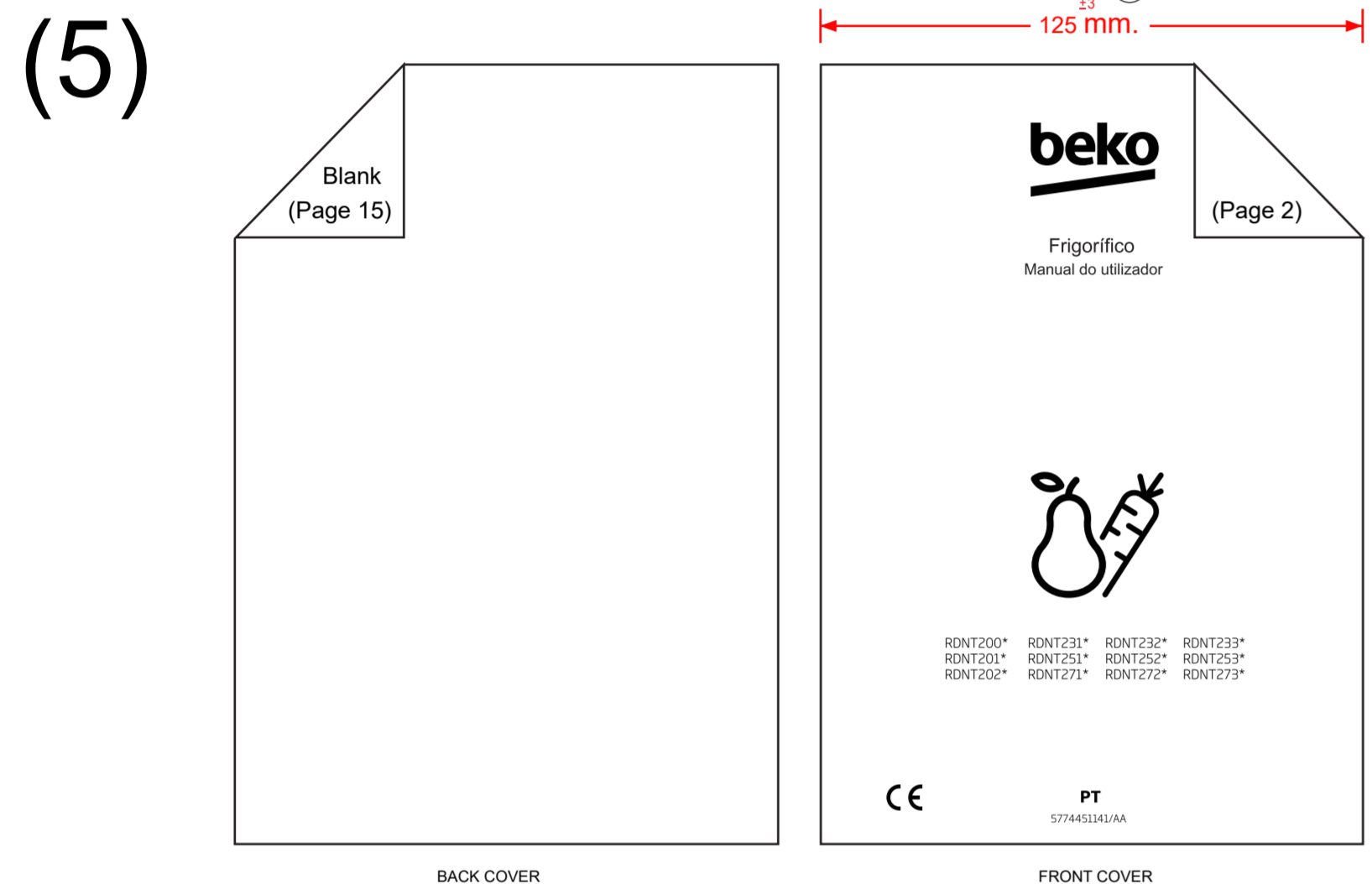

5774451141-AA : USER MANUAL

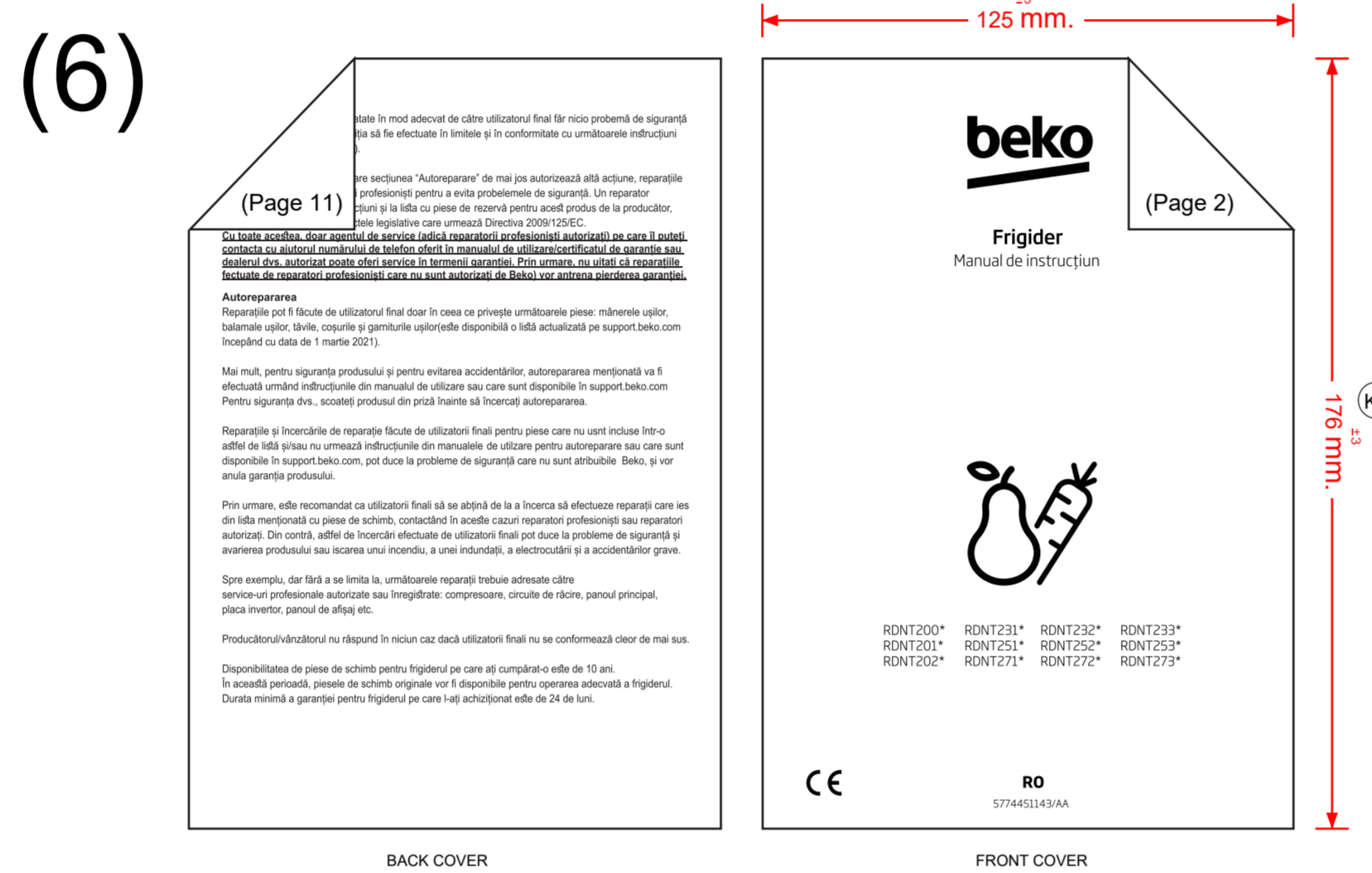

5774451143-AA : USER MANUAL

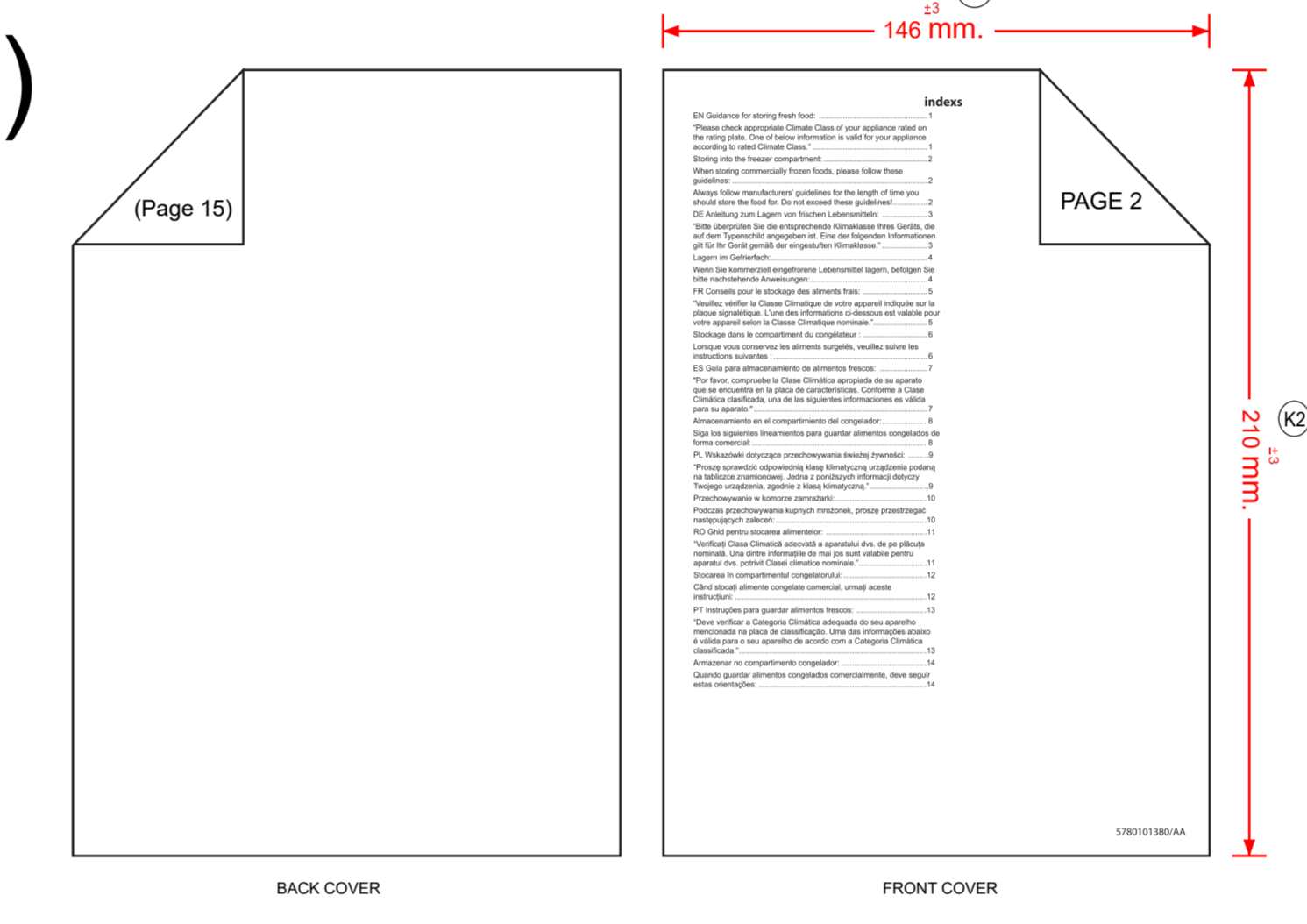

5780101380-AA : GUIDANCE SHEET

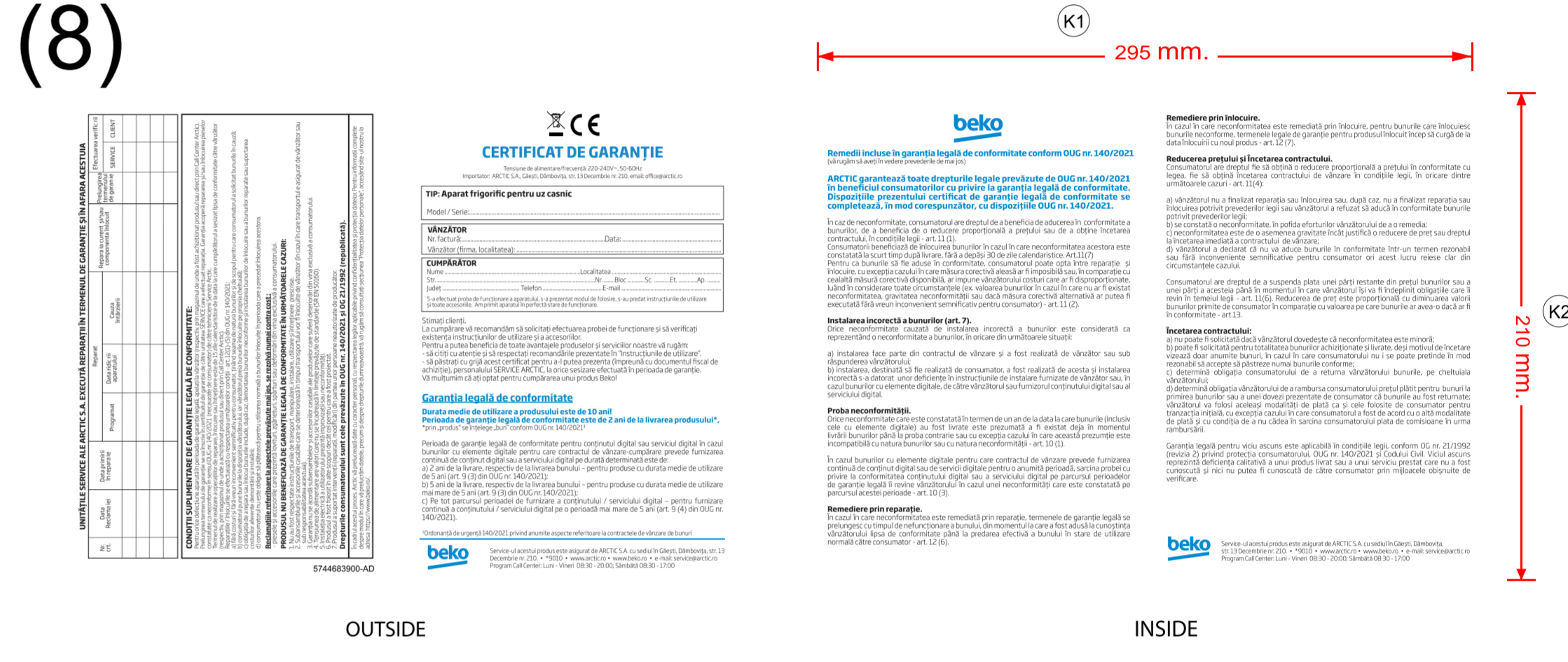

5744683900-AD : WARRANTY CARD

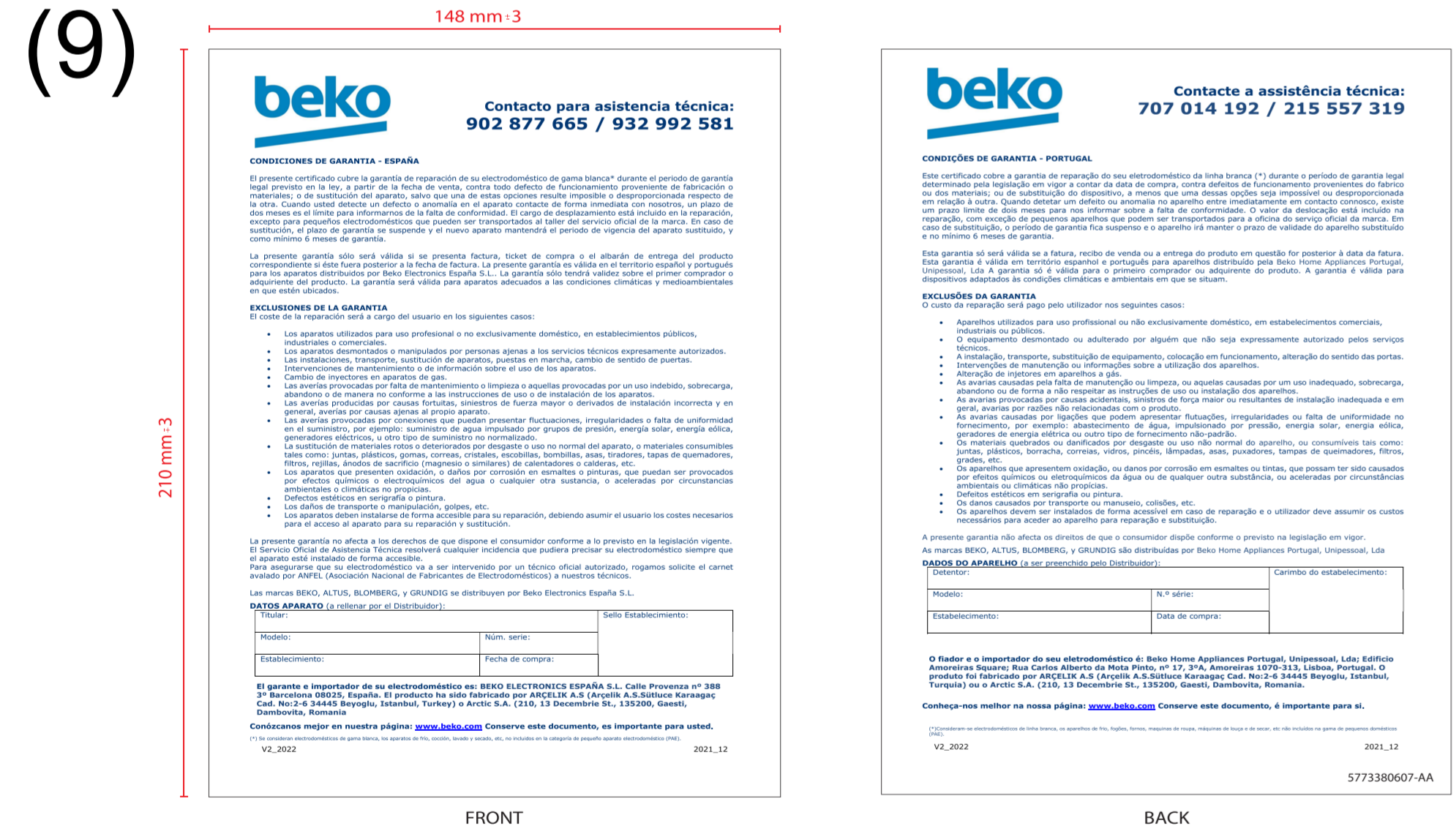

5773380607-AA : WARRANTY-CARD

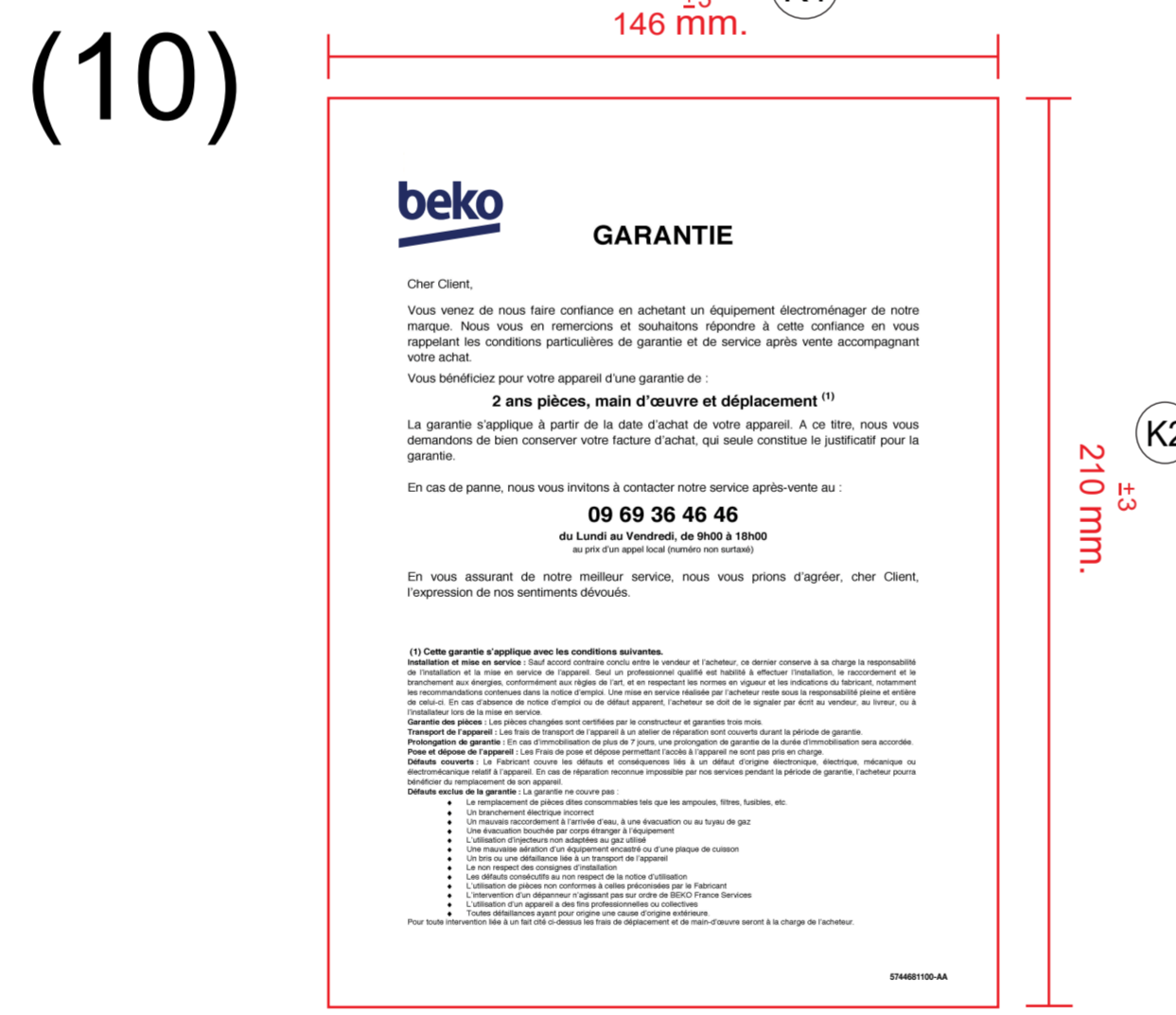

5744681100-AB : Warranty Beko

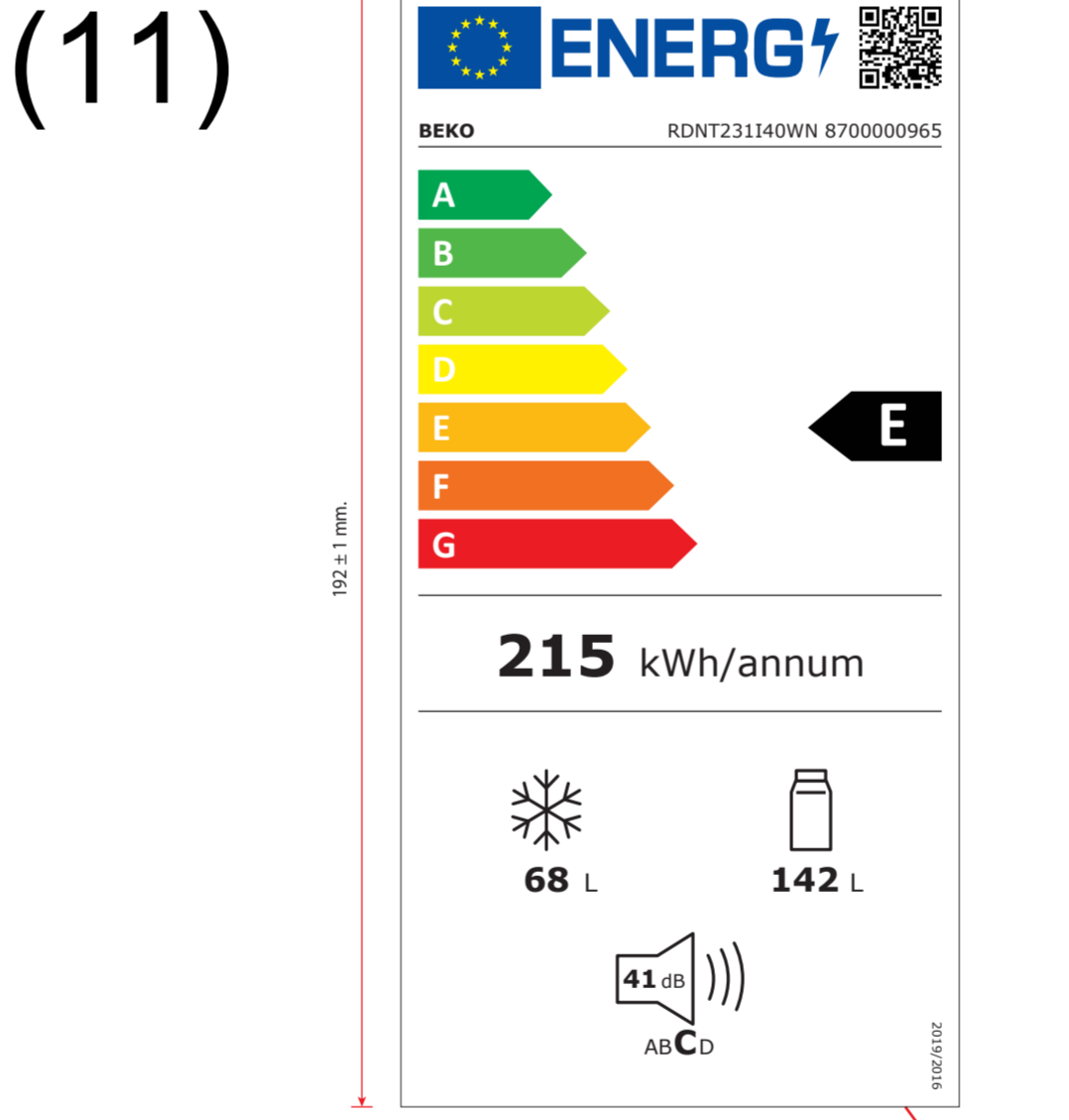

5773007339-AA : ENERGY_LABEL

CUSTOMER : BEKO THAI			
<input type="checkbox"/> Approved.	Comment :		
<input type="checkbox"/> Reject.			
App. By :		App. By :	
Dept :		Dept :	
Date :		Date :	

NOTES :
 Assy user manual 5918611704
 (1)+(2)+(3)+(4)+(5)+(6)+(7)+(8)+(9)+(10)
 +(11)

UNIT	mm	DRAWING	CHECK	APPROVED
SCALE	1:1	APIRADECH	JIRAPORN	NONGYOW
TOL		19-12-2023	19-12-2023	19-12-2023

PART NAME : User Manual
CODE NO : 5918611704
DRAWING NO :
REV : AA
Management of Art And Design Co.,Ltd.

8 7 6 5 4 3 2 1

D

D

C

C

B

B

A

A