

beko

Oven

User Manual

Pećnica

Uputstvo za upotrebu

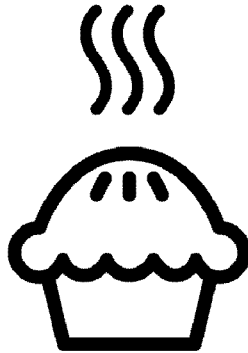

FSM67320GWS

EN / BS

285.3058.93/R.AB/10.03.2023/6-1

7785988326



RECYCLED &
RECYCLABLE PAPER

Please read this user manual first!

Dear Customer,

Thank you for purchasing this Beko product. We hope that you get the best results from your product which has been manufactured with high quality and state-of-the-art technology. Therefore, please read this entire user manual and all other accompanying documents carefully before using the product and keep it as a reference for future use. If you handover the product to someone else, give the user manual as well. Follow all warnings and information in the user manual.

Remember that this user manual is also applicable for several other models. Differences between models will be identified in the manual.

Explanation of symbols

Throughout this user manual the following symbols are used:



Important information or useful hints about usage.



Warning of hazardous situations with regard to life and property.



Warning of electric shock.



Warning of risk of fire.



Warning of hot surfaces.



Arçelik A.Ş.
Karaağaç caddesi No:2-6
34445 Sütlüce/Istanbul/TURKEY
Made in TURKEY

TABLE OF CONTENTS

1 Important instructions and warnings for safety and environment **4**

General safety	4
Electrical safety	5
Product safety.....	6
Intended use.....	9
Safety for children	9
Disposing of the old product	9
Package information.....	10

2 General information **11**

Overview	11
Package contents	12
Technical specifications	13

3 Installation **15**

Before installation.....	15
Installation and connection.....	16
Future Transportation	18

4 Preparation **20**

Tips for saving energy.....	20
Initial use	20
Time setting.....	20
First cleaning of the appliance	21
Initial heating.....	21

5 How to use the hob **22**

General information about cooking.....	22
Using the hobs.....	23

6 How to operate the oven **25**

General information on baking, roasting and grilling.....	25
How to operate the electric oven	26
Operating modes.....	26
Using the oven clock	27
Cooking times table	30
How to operate the grill.....	34
Cooking times table for grilling.....	34

7 Maintenance and care **35**

General information	35
Cleaning the hob	35
Cleaning the control panel.....	36
Cleaning the oven.....	36
Cleaning the oven door.....	37
Removing the door inner glass	38
Replacing the oven lamp.....	38

8 Troubleshooting **40**

1 Important instructions and warnings for safety and environment

This section contains safety instructions that will help protect from risk of personal injury or property damage. Failure to follow these instructions shall void any warranty.

General safety

- This appliance can be used by children aged from 8 years and above and persons with reduced physical, sensory or mental capabilities or lack of experience and knowledge if they have been given supervision or instruction concerning use of the appliance in a safe way and understand the hazards involved.

Children shall not play with the appliance. Cleaning and user maintenance shall not be made by children without supervision.

- The appliance is not to be used by persons (including children) with reduced physical, sensory or mental capabilities, or lack of experience and knowledge,

unless they have been given supervision or instruction. Children should be supervised and ensure they do not play with the appliance

- If the product is handed over to someone else for personal use or second-hand use purposes, the user manual, product labels and other relevant documents and parts should be also given.
- Never place the product on a carpet-covered floor. Otherwise, lack of airflow beneath the product will cause electrical parts to overheat. This will cause problems with your product.
- Installation and repair procedures must always be performed by Authorised Service Agents. The manufacturer shall not be held responsible for damages arising from procedures carried out by unauthorised persons which may also void the warranty. Before installation, read the instructions carefully.

- Do not operate the product if it is defective or has any visible damage.
- Ensure that the product function knobs are switched off after every use.

Electrical safety

- If the product has a failure, it should not be operated unless it is repaired by an Authorised Service Agent. There is the risk of electric shock!
- Only connect the product to a grounded outlet/line with the voltage and protection as specified in the “Technical specifications”. Have the grounding installation made by a qualified electrician while using the product with or without a transformer. Our company shall not be liable for any problems arising due to the product not being earthed in accordance with the local regulations.
- Never wash the product by spreading or pouring water onto it! There is the risk of electric shock!
- The product must be disconnected during installation, maintenance, cleaning and repairing procedures.
- If the power connection cable for the product is damaged, it must be replaced by the manufacturer, its service agent or similarly qualified persons in order to avoid a hazard.
- Only use the connection cable specified in the “Technical specifications”.
- The appliance must be installed so that it can be completely disconnected from the mains supply. The separation must be provided by a switch built into the fixed electrical installation, according to construction regulations.
- Rear surface of the oven gets hot when it is in use. Make sure that the electrical connection does not contact with the rear surface; otherwise, connections can get damaged.
- Do not trap the mains cable between the oven door and frame and do not route it over hot surfaces. Otherwise, cable insulation may melt and cause fire as a result of short circuit.

- Any work on electrical equipment and systems should only be carried out by authorised and qualified persons.
- In case of any damage, switch off the product and disconnect it from the mains. To do this, turn off the fuse at home.
- Make sure that fuse rating is compatible with the product.

Product safety

- **WARNING:** The appliance and its accessible parts become hot during use. Care should be taken to avoid touching heating elements. Children less than 8 years of age shall be kept away unless continuously supervised.
- Never use the product when your judgment or coordination is impaired by the use of alcohol and/or drugs.
- Be careful when using alcoholic drinks in your dishes. Alcohol evaporates at high temperatures and may cause fire since it can ignite when it comes into contact with hot surfaces.
- Food Poisoning Hazard: Do not let food sit in oven for more than 1 hour before or after cooking. Doing so can result in food poisoning or sickness.
- Do not place any flammable materials close to the product as the sides may become hot during use.
- During use the appliances becomes hot. Care should be taken to avoid touching heating elements inside the oven.
- Keep all ventilation slots clear of obstructions.
- Do not heat closed tins and glass jars in the oven. The pressure that would build-up in the tin/jar may cause it to burst.
- Do not place baking trays, dishes or aluminium foil directly onto the bottom of the oven. The heat accumulation might damage the bottom of the oven.
- Do not use harsh abrasive cleaners or sharp metal scrapers to clean the oven door glass since they can scratch the surface, which may result in shattering of the glass.

- Do not use steam cleaners to clean the appliance as this may cause an electric shock.
- (Varies depending on the product model.)

Placing the wire shelf and tray onto the wire racks properly

It is important to place the wire shelf and/or tray onto the rack properly. Slide the wire shelf or tray between 2 rails and make sure that it is balanced before placing food on it (Please see the following figure).

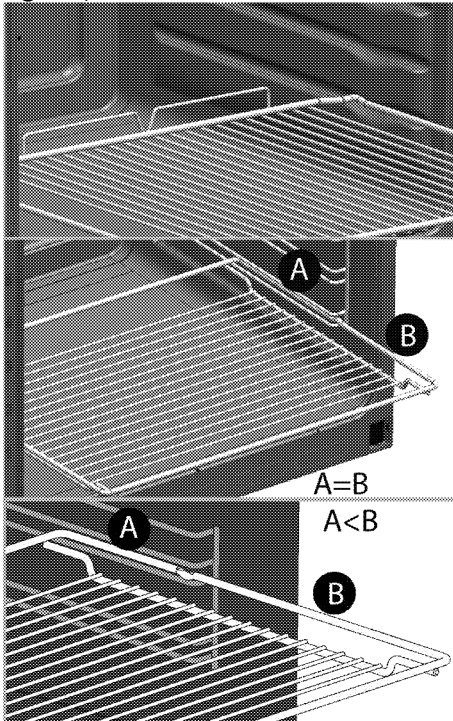

- Do not use the product if the front door glass is removed or cracked.
- Always use heat resistant oven gloves when putting in or removing dishes into/from the hot oven.
- Place the baking paper into the cooking pot or on to the oven accessory (tray, wire grill etc) together with the food and then insert all into the preheated oven. Remove the excess parts of the baking paper overflowing from the accessory or the pot in order to prevent the risk of touching the oven's heating elements. Never use the baking paper in an operating temperature higher than the indicated value for the baking paper. Do not place the baking paper directly on the base of the oven.
- **WARNING:** Ensure that power cord of the appliance is unplugged or circuit breaker is switched off before replacing the lamp to avoid the possibility of electric shock.
- The appliance must not be installed behind a decorative

- door in order to avoid overheating.
- Product must be placed directly on the floor. It must not be placed onto a base or a pedestal.
 - **WARNING:** Unattended cooking on a hob with fat or oil can be dangerous and may result in fire. NEVER try to extinguish a fire with water, but switch off the appliance and then cover flame e.g. with a lid or a fire blanket.
 - **CAUTION:** The cooking process has to be supervised. A short term cooking process has to be supervised continuously.
 - **WARNING:** Danger of fire: Do not store items on the cooking surfaces.
 - **WARNING:** If the surface is cracked, switch off the appliance to avoid the possibility of electric shock.
 - In case of hotplate glass breakage : Immediately shut off all burners and any electrical heating element and isolate the appliance from the power supply. Do not touch the appliance surface. Do not use the appliance.
 - The appliance is not intended to be operated by means of an external timer or separate remote-control system.
 - Vapour pressure that build up due to the moisture on the hob surface or at the bottom of the pot can cause the pot to move. Therefore, make sure that the hob surface and bottom of the pots are always dry.
 - **WARNING:** Use only hob guards designed by the manufacturer of the cooking appliance or indicated by the manufacturer of the appliance in the instructions for use as suitable or hob guards incorporated in the appliance. The use of inappropriate guards can cause accidents.
- Prevention against possible fire risk!
- Ensure all electrical connections are secure and tight to prevent risk of arcing.
 - Do not use damaged cables or extension cables.
 - Ensure liquid or moisture is not accessible to the electrical connection point.

Intended use

- This product is designed for domestic use. Commercial use will void the guarantee.
- **CAUTION:** This appliance is for cooking purposes only. It must not be used for other purposes, for example room heating.
- This product should not be used for warming the plates under the grill, drying towels, dish cloths etc. by hanging them on the oven door handles. This product should also not be used for room heating purposes.
- The manufacturer shall not be liable for any damage caused by improper use or handling errors.
- The oven can be used for defrosting, baking, roasting and grilling food.

Safety for children

- **WARNING:** Accessible parts may become hot during use. Young children should be kept away.
- The packaging materials will be dangerous for children. Keep the packaging materials away from children. Please dispose of all parts of the

packaging according to environmental standards.

- Electrical products are dangerous to children. Keep children away from the product when it is operating and do not allow them to play with the product.
- Do not place any items above the appliance that children may reach for.
- When the door is open, do not load any heavy object on it and do not allow children to sit on it. It may overturn or door hinges may get damaged.

Disposing of the old product

Compliance with the WEEE Directive and Disposing of the Waste Product:



This product complies with EU WEEE Directive (2012/19/EU). This product bears a classification symbol for waste electrical and electronic equipment (WEEE).

This product has been manufactured with high quality parts and materials which can be reused and are suitable for recycling. Do not dispose of the waste product with normal domestic and other wastes at the end of its service life. Take it to the collection center for the recycling of electrical and electronic equipment. Please consult your local authorities to learn about these collection centers.

Compliance with RoHS Directive:

The product you have purchased complies with EU RoHS Directive (2011/65/EU). It does not contain harmful and prohibited materials specified in the Directive.

Package information

- Packaging materials of the product are manufactured from recyclable

materials in accordance with our National Environment Regulations. Do not dispose of the packaging materials together with the domestic or other wastes. Take them to the packaging material collection points designated by the local authorities.

2 General information

Overview

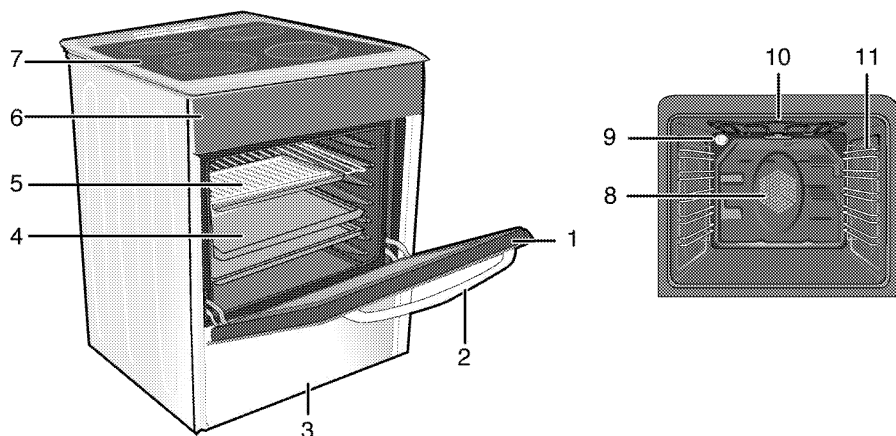

- | | |
|-----------------|----------------------------------|
| 1 Front door | 7 Burner plate |
| 2 Handle | 8 Fan motor (behind steel plate) |
| 3 Bottom drawer | 9 Lamp |
| 4 Tray | 10 Grill heating element |
| 5 Wire shelf | 11 Shelf positions |
| 6 Control panel | |

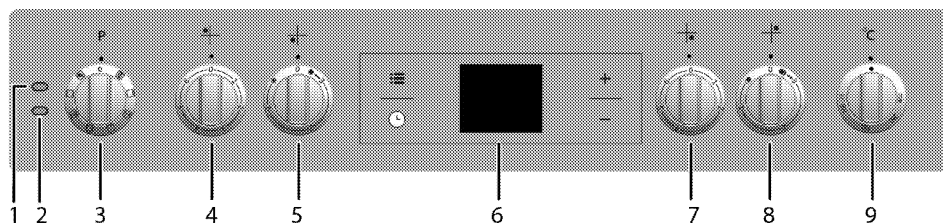

- | |
|--|
| 1 Warning lamp |
| 2 Thermostat lamp |
| 3 Function knob |
| 4 Single-circuit cooking plate Rear left |
| 5 Dual-circuit cooking plate Front left |
| 6 Digital timer |
| 7 Single-circuit cooking plate Front right |
| 8 Extended cooking plate Rear right |
| 9 Thermostat knob |

Package contents

i Accessories supplied can vary depending on the product model. Not every accessory described in the user manual may exist on your product.

1. User manual

2. Standard tray

Used for pastries, frozen foods and big roasts.

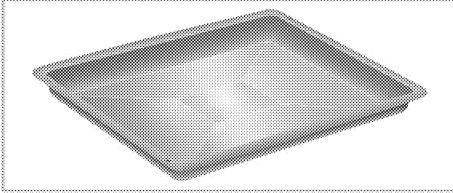

3. Pastry tray

Used for pastries such as cookies and biscuits.

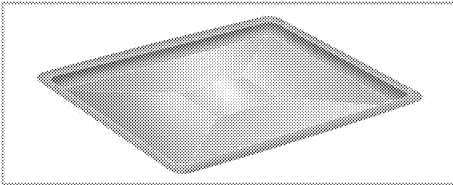

4. Wire grill

Used for roasting and for placing the food to be baked, roasted or cooked in casserole dishes to the desired rack.

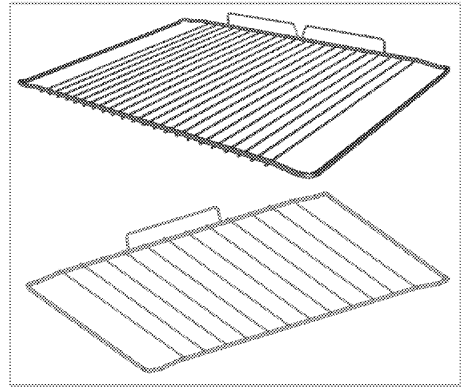
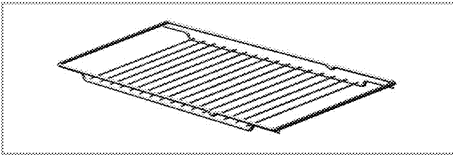

5. Placing the wire shelf and tray onto the telescopic racks properly (This feature is optional. It may not exist on your product.)

Telescopic racks allow you to install and remove the trays and wire shelf easily.

When using the tray and wire shelf with telescopic racks, make sure that the pins at the rear section of the telescopic rack stands against the edges of the wire shelf and tray.

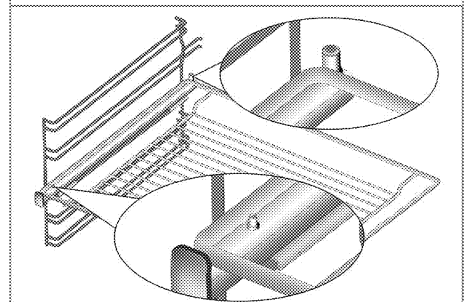
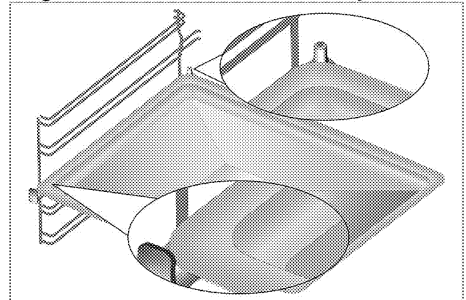

Technical specifications

GENERAL	
External dimensions (height / width / depth)	850 mm/600 mm/600 mm
Voltage / frequency	220-240 V 1N ~/380-415 V 3N ~ 50/60 Hz
Total power consumption	9.9 kW
Cable type / section	min.H05VV-FG 3 x 4 mm ² / 5 x 2,5 mm ²
HOB	
Burners	
Rear left	Single-circuit cooking plate
Dimension	140 mm
Power	1200 W
Front left	Dual-circuit cooking plate
Dimension	210/120 mm
Power	2200/750 W
Front right	Single-circuit cooking plate
Dimension	180 mm
Power	1700 W
Rear right	Extended cooking plate
Dimension	170/265 mm
Power	1500/2400 W
OVEN/GRILL	
Main oven	Multifunction oven
Inner lamp	15-25 W
Grill power consumption	2.2 kW

Basics: Information on the energy label of electrical ovens is given in accordance with the EN 60350-1 / IEC 60350-1 standard. Those values are determined under standard load with bottom-top heater or fan assisted heating (if any) functions.

Energy efficiency class is determined in accordance with the following prioritization depending on whether the relevant functions exist on the product or not. 1-Cooking with eco-fan, 2- Turbo slow cooking, 3- Turbo cooking, 4- Fan assisted bottom/top heating, 5-Top and bottom heating.

i Technical specifications may be changed without prior notice to improve the quality of the product.

i Figures in this manual are schematic and may not exactly match your product.

i Values stated on the product labels or in the documentation accompanying it are obtained in laboratory conditions in accordance with relevant standards. Depending on operational and environmental conditions of the product, these values may vary.

3 Installation

Product must be installed by a qualified person in accordance with the regulations in force. The manufacturer shall not be held responsible for damages arising from procedures carried out by unauthorized persons which may also void the warranty.

i Preparation of location and electrical installation for the product is under customer's responsibility.

! The product must be installed in accordance with all local electrical regulations.

! Prior to installation, visually check if the product has any defects on it. If so, do not have it installed. Damaged products cause risks for your safety.

Before installation

To ensure that critical air gaps are maintained under the appliance, we recommend that this appliance is mounted on a solid base and that the feet do not sink into any carpet or soft flooring.

The kitchen floor must be able to carry the weight of the appliance plus the additional weight of cookware and bakeware and food.

If the range is placed on a base, measures have to be taken to prevent the appliance slipping from the base. The appliances must not be installed behind a decorative door in order to avoid overheating.

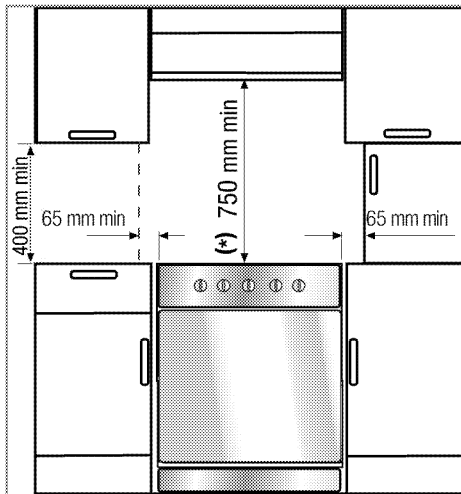

- The appliance corresponds to device class 1, i.e. it may be placed with the rear and **one** side to kitchen walls, kitchen furniture or equipment of any size. The kitchen furniture or equipment on the **other** side may only be of the same size or smaller.
- It can be used with cabinets on either side but in order to have a minimum distance of 400mm above hotplate level allow a side clearance of 65mm between the appliance and any wall, partition or tall cupboard.
- It can also be used in a free standing position. Allow a minimum distance of 750 mm above the hob surface.
- (*) If a cooker hood is to be installed above the cooker, refer to cooker hood manufacturer' instructions regarding installation height. If not defined any size in the hood manual, this height should be at least 650 mm.
- Any kitchen furniture next to the appliance must be heat-resistant (100 °C min.).

Safety chain

If your product has 2 safety chains;

The appliance must be secured against overbalancing by using the supplied two safety chains on your oven.

Fasten hook (1) by using a proper peg to the kitchen wall (6) and connect safety chain (3) to the hook via the locking mechanism (2).

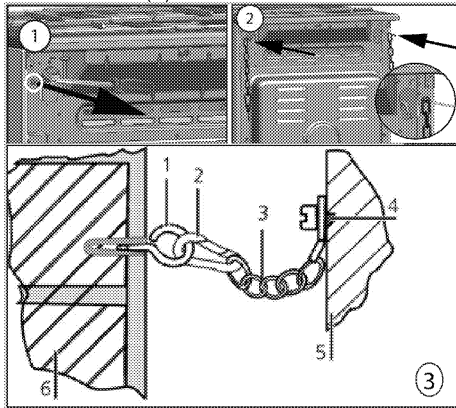

- 1 Stability hook
- 2 Locking mechanism
- 3 Safety chain (supplied and mounted to oven)
- 4 Firmly fix chain to cooker rear
- 5 Rear of cooker
- 6 Kitchen wall

If your product has 1 safety chain;

The appliance must be secured against overbalancing by using the supplied one safety chain on your oven.

Follow below steps in the picture to secure the safety chain to your product.

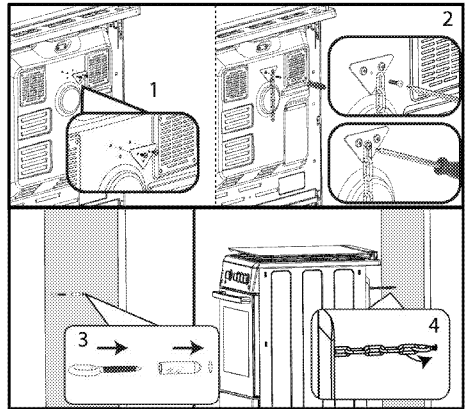

- i** Stability chain to be as short as practicable to avoid oven tilting forward and diagonal to avoid oven side tilting.

Cooker stability chain for cookers is not designed with bracket engagement slot.

Installation and connection

Product can only be installed and connected in accordance with the statutory installation rules.

- i** Do not install the product next to refrigerators or freezers. The heat emitted by the product will increase the energy consumption of cooling appliances.

- Carry the product with at least two persons.
- Product must be placed directly on the floor. It must not be placed onto a base or a pedestal.

- i** Do not use the door and/or handle to carry or move the product. The door, handle or hinges get damaged.

Electrical connection

Connect the product to a grounded outlet/line protected by a miniature circuit breaker of suitable capacity as stated in the "Technical specifications" table. Have the grounding installation

made by a qualified electrician while using the product with or without a transformer. Our company shall not be liable for any damages that will arise due to using the product without a grounding installation in accordance with the local regulations.

 The product must be connected to the mains supply only by an authorised and qualified person. The product's warranty period starts only after correct installation.

Manufacturer shall not be held responsible for damages arising from procedures carried out by unauthorised persons.

 The power cable must not be clamped, bent or trapped or come into contact with hot parts of the product.

A damaged power cable must be replaced by a qualified electrician. Otherwise, there is risk of electric shock, short circuit or fire!

The mains supply data must correspond to the data specified on the type label of the product. The rating plate is either seen when the door or the lower cover is opened or it is located at the rear wall of the unit depending on the unit type. Power cable of your product must comply with the values in "Technical specifications" table.

 Before starting any work on the electrical installation, disconnect the product from the mains supply.
There is the risk of electric shock!

Connecting the power cable

 While performing the wiring, you must apply with the national/local electrical regulations and must use the appropriate socket outlet/line and plug for oven. In case of the product's power limits are out of current carrying capability of plug and socket outlet/line, the product must be connected through fixed electrical installation directly without using plug and socket outlet/line.

1. **If a power cable is not supplied together with your product**, a power cable that you would select from the table (*Technical specifications, page 13*) in accordance with the electrical installation at your home must be connected to your product by following the instructions in cable diagram.

If it is not possible to disconnect all poles in the supply power, a disconnection unit with at least 3 mm contact clearance (fuses, line safety switches, contactors) must be connected and all the poles of this disconnection unit must be adjacent to (not above) the product in accordance with IEE directives. Failure to obey this instruction may cause operational problems and invalidate the product warranty.

 Additional protection by a residual current circuit breaker is recommended.

2. Open the terminal block cover with a screwdriver.
3. Insert the power cable through the cable clamp below the terminal and secure it to the main body with the integrated screw on cable clamping component.

4. Connect the cables according to the supplied diagram.

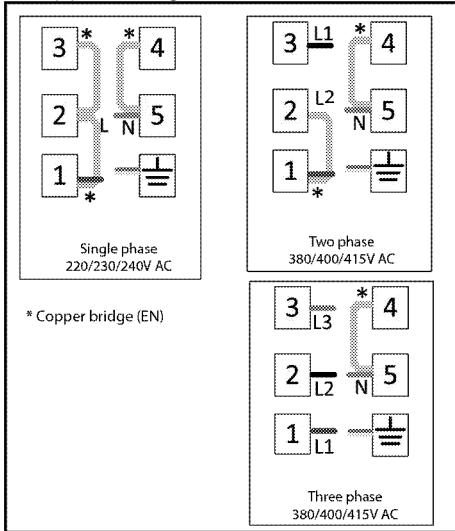

5. After completing the wire connections, close the terminal block cover.

6. Route the power cable so that it will not contact the product and get squeezed between the product and the wall.

i Power cable must not be longer than 2m because of safety reasons.

- Push the product towards the kitchen wall.
- **Adjusting the feet of oven**
Vibrations during use may cause cooking vessels to move. This dangerous situation can be avoided if the product is level and balanced. For your own safety please ensure the product is level by adjusting the four feet at the bottom by turning left or right and align level with the work top.

For products with cooling fan (This may not exist on your product.)

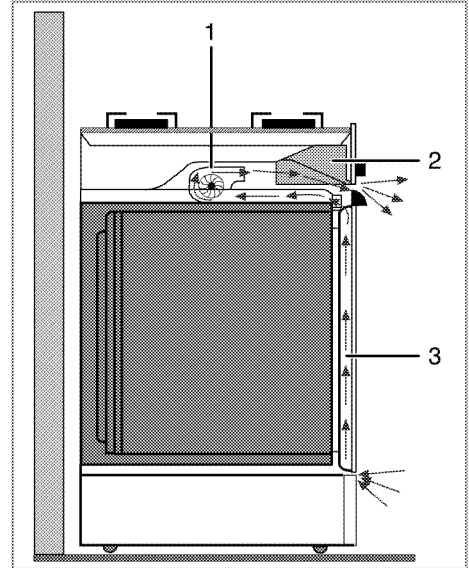

- 1 Cooling fan
- 2 Control panel
- 3 Door

The cooling fan cools both the control panel and the front of the appliance.

i Cooling fan continues to run for up to 20-30 minutes (approx.) even after the oven is turned off.

Final check

1. Reconnect the product to the mains.
2. Check electrical functions.

Future Transportation

- Keep the product's original carton and transport the product in it. Follow the instructions on the carton. If you do not have the original carton, pack the product in bubble wrap or thick cardboard and tape it securely.
- To prevent the wire grill and tray inside the oven from damaging the oven door, place a strip of cardboard onto the inside of the oven door that lines

up with the position of the trays. Tape the oven door to the side walls.

- Do not use the door or handle to lift or move the product.

i Do not place any objects onto the product and move it in upright position.

i Check the general appearance of your product for any damages that might have occurred during transportation.

4 Preparation

Tips for saving energy

The following information will help you to use your appliance in an ecological way, and to save energy:

- Use dark coloured or enamel coated cookware in the oven since the heat transmission will be better.
- While cooking your dishes, perform a preheating operation if it is advised in the user manual or cooking instructions.
- Do not open the door of the oven frequently during cooking.
- Try to cook more than one dish in the oven at the same time whenever possible. You can cook by placing two cooking vessels onto the wire shelf.
- Cook more than one dish one after another. The oven will already be hot.
- You can save energy by switching off your oven a few minutes before the end of the cooking time. Do not open the oven door.
- Defrost frozen dishes before cooking them.
- Use pots/pans with cover for cooking. If there is no cover, energy consumption may increase 4 times.
- Select the burner which is suitable for the bottom size of the pot to be used. Always select the correct pot size for your dishes. Larger pots require more energy.
- Pay attention to use flat bottom pots when cooking with electric hobs. Pots with thick bottom will provide a better heat conduction. You can obtain energy savings up to 1/3.
- Vessels and pots must be compatible with the cooking zones. Bottom of the vessels or pots must not be smaller than the hotplate.

- Keep the cooking zones and bottom of the pots clean. Dirt will decrease the heat conduction between the cooking zone and bottom of the pot.
- For long cookings, turn off the cooking zone 5 or 10 minutes before the end of cooking time. You can obtain energy savings up to 20% by using the residual heat.
- Information on energy efficiency according to EU 66/2014 can be found on the product fiche given with the product.

Initial use

Time setting

- i** While making any adjustment, related symbols will flash on the display.

Press **+**/**-** keys to set the time of the day after the oven is energized for the first time.

- i** For touch control models, touch  first and then use **+** / **-** to set the time of the day.

Confirm the setting by touching  symbol and wait for 4 seconds without touching any keys to confirm.

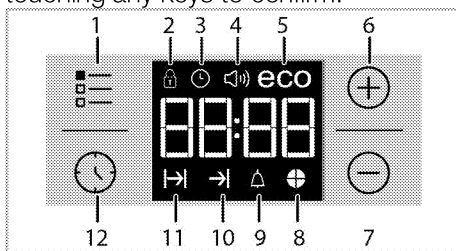

- 1 Adjustment key
- 2 Key lock symbol
- 3 Clock symbol
- 4 Alarm volume symbol *
- 5 Eco mode symbol
- 6 Plus key

- 7 Minus key
- 8 Time slice symbol
- 9 Alarm symbol
- 10 End of Cooking Time symbol*
- 11 Cooking Time symbol
- 12 Program key
- * (Varies depending on the product model.)

i If the initial time is not set, clock will run starting from 12:00 and  symbol will be displayed. The symbol will disappear once the time is set.

i Current time settings are canceled in case of power failure. It needs to be readjusted.

First cleaning of the appliance

i The surface might get damaged by some detergents or cleaning materials.
Do not use aggressive detergents, cleaning powders/creams or any sharp objects during cleaning.
Do not use harsh abrasive cleaners or sharp metal scrapers to clean the oven door glass since they can scratch the surface, which may result in shattering of the glass.

1. Remove all packaging materials.
2. Wipe the surfaces of the appliance with a damp cloth or sponge and dry with a cloth.

Initial heating

Heat up the product for about 30 minutes and then switch it off. Thus, any production residues or layers will be burnt off and removed.



Hot surfaces cause burns!
Product may be hot when it is in use. Never touch the hot burners, inner sections of the oven, heaters and etc. Keep children away.
Always use heat resistant oven gloves when putting in or removing dishes into/from the hot oven.

Electric oven

1. Take all baking trays and the wire grill out of the oven.
2. Close the oven door.
3. Select Static position.
4. Select the highest grill power; See *How to operate the electric oven, page 26*.
5. Operate the oven for about 30 minutes.
6. Turn off your oven; See *How to operate the electric oven, page 26*

Grill oven

1. Take all baking trays and the wire grill out of the oven.
2. Close the oven door.
3. Select the highest grill power; see *How to operate the grill, page 34*.
4. Operate the grill about 15 minutes.
5. Turn off your grill; see *How to operate the grill, page 34*



Smoke and smell may emit for a couple of hours during the initial operation. This is quite normal. Ensure that the room is well ventilated to remove the smoke and smell. Avoid directly inhaling the smoke and the smell that emits.

5 How to use the hob

General information about cooking



Never fill the pan with oil more than one third of it. Do not leave the hob unattended when heating oil. Overheated oils bring risk of fire. **Never attempt to extinguish a possible fire with water!**

When oil catches fire, cover it with a fire blanket or damp cloth. Turn off the hob if it is safe to do so and call the fire department.

- Before frying foods, always dry them well and gently place into the hot oil. Ensure complete thawing of frozen foods before frying.
- Do not cover the vessel you use when heating oil.
- Place the pans and saucepans in a manner so that their handles are not over the hob to prevent heating of the handles. Do not place unbalanced and easily tilting vessels on the hob.
- Do not place empty vessels and saucepans on cooking zones that are switched on. They might get damaged.
- Operating a cooking zone without a vessel or saucepan on it will cause damage to the product. Turn off the cooking zones after the cooking is complete.
- As the surface of the product can be hot, do not put plastic and aluminum vessels on it. Clean any melted such materials on the surface immediately. Such vessels should not be used to keep foods either.
- Use flat bottomed saucepans or vessels only.

- Put appropriate amount of food in saucepans and pans. Thus, you will not have to make any unnecessary cleaning by preventing the dishes from overflowing.

Do not put covers of saucepans or pans on cooking zones.

Place the saucepans in a manner so that they are centered on the cooking zone. When you want to move the saucepan onto another cooking zone, lift and place it onto the cooking zone you want instead of sliding it.

Tips about glass ceramic hobs

- Glass ceramic surface is heatproof and is not affected by big temperature differences.
- Do not use the glass ceramic surface as a place of storage or as a cutting board.
- Use only the saucepans and pans with machined bottoms. Sharp edges create scratches on the surface.
- Do not use aluminum vessels and saucepans. Aluminum damages the glass ceramic surface.

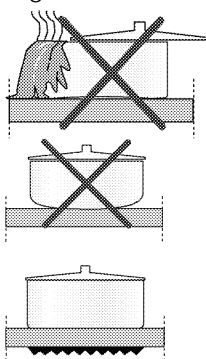

Spills may damage the glass ceramic surface and cause fire.

Do not use vessels with concave or convex bottoms. Use only the saucepans and pans with flat bottoms. They ensure easier heat transfer.

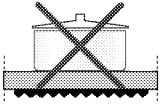

If the diameter of the saucepan is too small, energy will be wasted.

Using the hobs

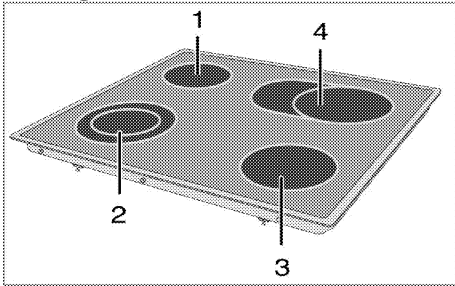

- 1 Single-circuit cooking plate 14-16cm
- 2 Dual-circuit cooking plate 21-23/12-14cm
- 3 Single-circuit cooking plate 18-20cm
- 4 Extended cooking plate 17-19/26-28cm is list of advised diameter of pots to be used on related burners.

! Do not allow any object to drop on the hob. Even small objects such as a saltshaker may damage the hob.

Do not use cracked hobs. Water may leak through these cracks and cause short circuit.

In case of any kind of damage on the surface (eg., visible cracks), switch off the product immediately to minimize the risk of electric shock.

Glass ceramic hob is equipped with an operation light and a hot zone warning indicator.

Hot zone warning indicator indicates the status of the active zone and it remains lit after the plate is turned off. Flickering

of the hot zone warning indicator is not a failure.



Depending on the usage, the hob surface may cool down at varying periods of time. Hob surface may be hot even if the indicator lamps are not illuminated. Make sure that the surface is cooled down before touching. Otherwise, you might burn your hand!



Quick heating glass-ceramic hobs emit a bright light when they are switched on. Do not stare at the bright light.

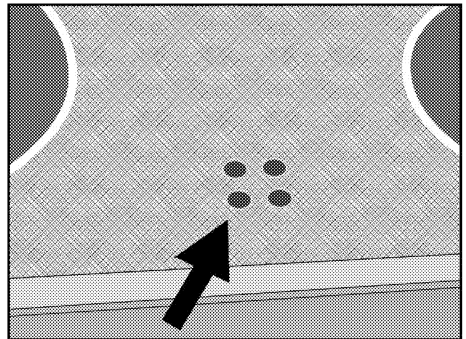

Turning on the ceramic plates

The hob control knobs are used for operating the plates. To obtain the desired cooking power, turn the hob control knobs to the corresponding level.

Cooking level	1	2 – 3	4 – 6
	warming	stewing, simmering	cooking, roasting, boiling

Cooking level	1	2	3
	warming	stewing, simmering	cooking, roasting, boiling

Turning off the ceramic plates

Turn the plate knob to OFF (upper) position.

Using multi-segmented cooking zones

Multi-segmented cooking zones allows to cook with different size of saucepans on the same cooking zone. When these cooking zones are activated, first the inward cooking zone turns on.

- To change the active cooking zone diameter, turn the control knob clockwise.
- A "click" will be heard as soon as the hotplate radius changes.

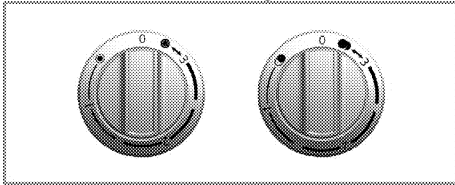

Turning off multi-segment cooking zones

- Turn the knob counter clockwise to OFF (upper) position to turn off the oven. All segments of the cooking zone are turned off.

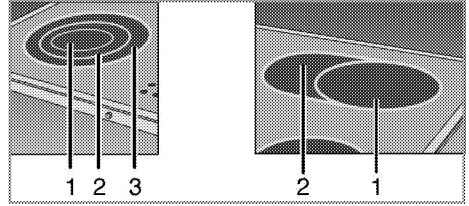

- Position 1
- Position 2
- Position 3

i Position 2 and 3 of the multi-segment cooking zones do not operate independently.

6 How to operate the oven

General information on baking, roasting and grilling



Hot surfaces cause burns! Product may be hot when it is in use. Never touch the hot burners, inner sections of the oven, heaters and etc. Keep children away. Always use heat resistant oven gloves when putting in or removing dishes into/from the hot oven.



Be careful when opening the oven door as steam may escape. Exiting steam can scald your hands, face and/or eyes.

Tips for baking

- Use non-sticky coated appropriate metal plates or aluminum vessels or heat-resistant silicone moulds.
- Make best use of the space on the rack.
- Place the baking mould in the middle of the shelf.
- Select the correct rack position before turning the oven or grill on. Do not change the rack position when the oven is hot.
- Keep the oven door closed.

Tips for roasting

- Treating whole chicken, turkey and large piece of meat with dressings such as lemon juice and black pepper before cooking will increase the cooking performance.
- It takes about 15 to 30 minutes longer to roast meat with bones when compared to roasting the same size of meat without bones.

- Each centimeter of meat thickness requires approximately 4 to 5 minutes of cooking time.
- Let meat rest in the oven for about 10 minutes after the cooking time is over. The juice is better distributed all over the roast and does not run out when the meat is cut.
- Fish should be placed on the middle or lower rack in a heat-resistant plate.

Tips for grilling

When meat, fish and poultry are grilled, they quickly get brown, have a nice crust and do not get dry. Flat pieces, meat skewers and sausages are particularly suited for grilling as are vegetables with high water content such as tomatoes and onions.

- Distribute the pieces to be grilled on the wire shelf or in the baking tray with wire shelf in such a way that the space covered does not exceed the size of the heater.
- Slide the wire shelf or baking tray with grill into the desired level in the oven. If you are grilling on the wire shelf, slide the baking tray to the lower rack to collect fats. The baking tray to be slid must be of a size that covers the whole grilling area. This tray might not be provided with the product. Add some water in the baking tray for easy cleaning.



Foods that are not suitable for grilling carry the risk of fire. Only grill food which is suitable for intensive grilling heat. Do not place the food too far in the back of the grill. This is the hottest area and fatty food may catch fire.

How to operate the electric oven

Select temperature and operating mode

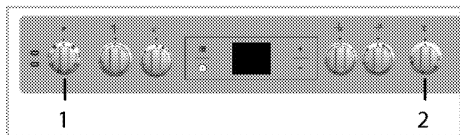

- 1 Function knob
- 2 Thermostat knob

1. Set the Function knob to the desired operating mode.

2. Set the Temperature knob to the desired temperature.

» Oven heats up to the adjusted temperature and maintains it. During heating, temperature lamp stays on.

Switching off the electric oven

Turn the function knob and temperature knob to off (upper) position.

Rack positions (For models with wire shelf)

It is important to place the wire shelf onto the side rack correctly. Wire shelf must be inserted between the side racks as illustrated in the figure.

Do not let the wire shelf stand against the rear wall of the oven. Slide your wire shelf to the front section of the rack and settle it with the help of the door in order to obtain a good grill performance.

(Varies depending on the product model.)

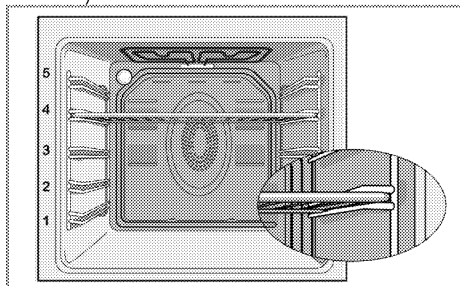

Operating modes

The order of operating modes shown here may be different from the arrangement on your product.

Top and bottom heating



Top and bottom heating are in operation. Food is heated simultaneously from the top and bottom. For example, it is suitable for cakes, pastries, or cakes and casseroles in baking moulds. Cook with one tray only.

Bottom heating



Only bottom heating is in operation. It is suitable for pizza and for subsequent browning of food from the bottom.



This function must be used for easy steam cleaning as well.

Fan supported bottom/top heating



Top heating, bottom heating plus fan (in the rear wall) are in operation. Hot air is evenly distributed throughout the oven rapidly by means of the fan. Cook with one tray only.

Operating with fan



The oven is not heated. Only the fan (in the rear wall) is in operation. Suitable for thawing frozen granular food slowly at room temperature and cooling down the cooked food. The time required to thaw a whole piece of meat is longer than the food with grains.

Fan Heating



Warm air heated by the rear heater is evenly distributed throughout the oven rapidly by means of the fan.



It is suitable for cooking your meals in different rack levels and preheating is not required in most cases. Suitable for cooking with multi trays.

This function must be used for easy steam cleaning as well.

"3D" function



Top heating, bottom heating and fan assisted heating (in the rear wall) are in operation. Food is cooked evenly and quickly all around. Cook with one tray only.

Full grill



Large grill at the ceiling of the oven is in operation. It is suitable for grilling large amount of meat.

- Put big or medium-sized portions in correct rack position under the grill heater for grilling.
- Turn the food after half of the grilling time.

Grill+Fan



Grilling effect is not as strong as in Full Grill

- Put small or medium-sized portions in correct shelf position under the grill heater for grilling.
- Turn the food after half of the grilling time.

Using the oven clock

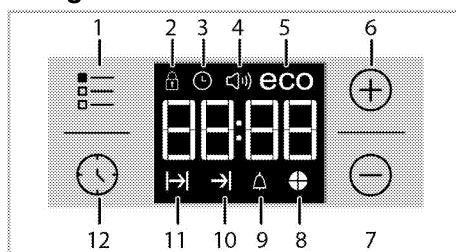

- 1 Adjustment key
- 2 Key lock symbol
- 3 Clock symbol
- 4 Alarm volume symbol *
- 5 Eco mode symbol
- 6 Plus key
- 7 Minus key
- 8 Time slice symbol
- 9 Alarm symbol
- 10 End of Cooking Time symbol*
- 11 Cooking Time symbol

12 Program key

* (Varies depending on the product model.)

i Maximum time that can be set for end of cooking is 5 hours 59 minutes.
Program will be cancelled in case of power failure. You must reprogram the oven.



i While making any setting, related symbols will flash on the display. You must wait for a short time for the settings to take effect.

i If no cooking setting is made, time of the day cannot be set.

i Remaining time will be displayed if cooking time is set when the cooking starts.

Cooking by setting the cooking time;









You can set the oven so that it will stop at the end of the specified time by setting the cooking time on the timer.

1. Select the function for cooking.
2. Touch  until  symbol appears on display for cooking time.
3. Set the cooking time with **+** / **-** keys.
» » After the cooking time is set,  symbol and the time slice will appear on display continuously.
4. Place the dish into the oven and set the temperature with temperature knob. Cooking will start.
» Cooking time starts to count down on display when cooking starts and all parts of time slice symbol is lit. The set cooking time is divided into 4 equal

parts and when the time of each parts ends, the symbol of that parts turns off. So you can understand the ratio of remaining cooking time to total cooking time easily.

Setting the the end of cooking time to a later time; (This feature is optional. It may not exist on your product.)

After setting the cooking time on the timer, you can set the end of cooking time to a later time.

1. Select the function for cooking.
2. Touch  until  symbol appears on display for cooking time.
3. Set the cooking time with **+** / **-** keys.
» » Once the Cooking Time is set,  symbol will appear on display continuously.
4. Touch  until  symbol appears on display for the end of cooking time.
5. Press **+** / **-** keys to set the end of cooking time.
» After the cooking time is set,  symbol plus  symbol and the time slice will appear on display continuously. Once the cooking starts,  symbol disappears.
6. Place the dish into the oven and set the temperature with temperature knob. Cooking will start.
» **Oven timer calculates the startup time by deducting the cooking time you have set.** Selected operating mode is activated when the startup time of cooking has come and the oven is heated up to the set temperature. It maintains this temperature until the end of cooking time.
» Cooking time starts to count down on display when cooking starts and all parts of time slice symbol is lit. The set cooking time is divided into 4 equal parts and when the time of each parts

ends, the symbol of that parts turns off. So you can understand the ratio of remaining cooking time to total cooking time easily.

7. After the cooking process is completed, **"End"** appears on the displayed and the timer gives an audio warning.

8. Audio warning sounds for 2 minutes. To stop the audio warning, just press any key. Audio warning will be silenced and current time will be displayed.

i If you press any key at the end of the audio warning, the oven will restart operating. Turn the temperature knob and function knob to **"0"** (off) position to switch off the oven in order to prevent re-operation of the oven at the end of warning.

Activating the keylock

You can prevent digital timer from being intervened with by activating the key lock function.

1. Touch  until  symbol appears on display.

» **"OFF"** will appear on the display.

2. Press **+** to activate the key lock.

» Once the key lock is activated, **"On"** appears on the display and the  symbol remains lit.

i Digital timer keys are not functional when the key lock is activated. Key lock will not be cancelled in case of power failure.

To deactivate the keylock

1. Touch  until  symbol appears on display.

» **"On"** will appear on the display.



2. Disable the key lock by pressing the **-** key.

» **"OFF"** will be displayed once the keylock is deactivated.

Setting the alarm clock

You can use the timer of the product for any warning or reminder apart from the cooking program.

The alarm clock has no influence on the functions of the oven. It is only used as a warning. For example, this is useful when you want to turn food in the oven at a certain point of time. Timer will give an audio warning at the end of the set time.

1. Touch  until  symbol appears on display.

i Maximum alarm time can be 23 hours and 59 minutes.

2. Set the alarm duration by using **+** / **-** keys.

i Function keys for alarm tone, time of day, display brightness and temperature keys should be at 0 (OFF) position.

»  symbol will remain lit and the alarm time will appear on the display once the alarm time is set.

3. At the end of the alarm time,  symbol starts flashing and the audio warning is heard.



Turning off the alarm

1. Audio warning sounds for 2 minutes.

To stop the audio warning, just press any key.

» Audio warning will be silenced and current time will be displayed.



Cancelling the alarm;

1. Touch  until  symbol appears on display in order to cancel the alarm.

2. Press and hold **-** key until **"00:00"** is displayed.



i Alarm time will be displayed. If the alarm time and cooking time are set concurrently, shortest time will be displayed.

Changing alarm tone

1. Touch  until  symbol appears on display.
 2. Adjust the desired alarm tone with **+** / **-** keys.
 3. The tone you have set will be activated in a short time.
- » Selected alarm tone will appear as "b-01", "b-02" or "b-03" on the display.

Changing the time of the day

To change the time of the day you have previously set:

1. Touch  until  symbol appears on display.
2. Set the time of the day with **+** / **-** keys.
3. The time you have set will be activated in a short time.

Economy mode

You can save energy with economy mode while cooking by setting cooking time in the oven.

This mode completes the cooking with the inner temperature of the oven by switching off the heaters before the end of cooking time.

Setting the economy mode

1. Touch  symbol until **eco** symbol appears on display.
- » "OFF" will appear on the display.
2. Enable economy mode by touching **+** key.

» Once the economy mode is activated, "On" appears on the display and the eco symbol remains lit.

Disabling economy mode

1. Touch  symbol until **eco** symbol appears on display.
- » "On" will appear on the display.
2. Disable economy mode by touching **-** key.
- » "Off" will be displayed once the eco mode is deactivated.

Setting the screen brightness

(This feature is optional. It may not exist on your product.)







1. Touch  until **d-01** or **d-02** or **d-03** appears on display for display brightness.
 2. Set the desired brightness with **+** / **-** keys.
- » The time you have set will be activated in a short time.







Cooking times table







 The timings in this chart are meant as a guide. Timings may vary due to temperature of food, thickness, type and your own preference of cooking.

Baking and roasting

 1st rack of the oven is the **bottom** rack.

Dish	Cooking level number	Accessory to use	Operating mode	Rack position	Temperature (°C)	Cooking time (approx. in min.)
Cakes in tray	One level	Standard tray*		3	180	25 ... 30
Cakes in mould	One level	Cake mold on wire grill**		2	180	40 ... 50
Small cakes	One level	Standard tray*		3	160	25 ... 35
	One level	Standard tray*		3	150	30 ... 40
	2 levels	1-Pastry tray* 3-Standard tray*		1 - 3	150	35 ... 50
	3 levels	1-Standard tray* 3-Pastry tray* 5-Deep tray*		1 - 3 - 5	150	35 ... 50

Dish	Cooking level number	Accessory to use	Operating mode	Rack position	Temperature (°C)	Cooking time (approx. in min.)
Sponge cake	One level	Round springform pan with a diameter of 26 cm on wire grill**		3	160	25 ... 35
	One level	Round springform pan with a diameter of 26 cm on wire grill**		2	150	30 ... 40
	2 levels	1-Round springform pan with a diameter of 26 cm on wire grill** 4-Round springform pan with a diameter of 26 cm on pastry tray**		1 - 4	150	35 ... 45
Cookies	One level	Pastry tray*		3	180	25 ... 30
	2 levels	1-Pastry tray* 3-Standard tray*		1 - 3	180	30 ... 40
	3 levels	1-Pastry tray* 3-Standard tray* 5-Deep tray*		1 - 3 - 5	180	35 ... 45
Dough pastry	One level	Standard tray*		2	200	30 ... 40
	2 levels	1-Pastry tray* 5-Standard tray*		1 - 5	200	45 ... 55
	3 levels	1-Pastry tray* 3-Standard tray* 5-Deep tray*		1 - 3 - 5	200	55 ... 65
Rich pastry	One level	Standard tray*		2	200	25 ... 35
	2 levels	1-Pastry tray* 3-Standard tray*		1 - 3	200	35 ... 45
	3 levels	1-Pastry tray* 3-Standard tray* 5-Deep tray*		1 - 3 - 5	190	45 ... 55
Leaven	One level	Standard tray*		2	200	35 ... 45
Lasagna	One level	Glass/metal rectangular pan on wire grill**		2 - 3	200	30 ... 40
Pizza	One level	Standard tray*		2	200 ... 220	15 ... 20
Beef steak (whole) / Roast	One level	Standard tray*		3	25 min. 250/max, then 180 ... 190	100 ... 120
Leg of Lamb (casserole)	One level	Standard tray*		3	25 min. 250/max, then 190	70 ... 90

Dish	Cooking level number	Accessory to use	Operating mode	Rack position	Temperature (°C)	Cooking time (approx. in min.)
	One level	Standard tray*		3	25 min. 250/max, then 190	60 ... 80
Roasted chicken (1,8-2 kg)	One level	Standard tray*		2	15 min. 250/max, then 180 ... 190	60 ... 80
	One level	Standard tray*		2	15 min. 250/max, then 180 ... 190	60 ... 80
Turkey (5.5 kg)	One level	Standard tray*		1	25 min. 250/max, then 180 ... 190	150 ... 210
	One level	Standard tray*		1	25 min. 250/max, then 180 ... 190	150 ... 210
Fish	One level	Standard tray*		3	200	20 ... 30
	One level	Standard tray*		3	200	20 ... 30

It is suggested to perform preheating for all foods.









* These accessories may not be supplied with the product.



** These accessories are not supplied with the product. They are commercially available accessories.

Cooking table for test meals

Meals in this cooking table are prepared according to EN 60350-1 to make it

easier for control institutes to test the product.

Dish	Cooking level number	Accessory to use	Operating mode	Rack position	Temperature (°C)	Cooking time (approx. in min.)
Shortbread	One level	Standard tray*		3	140	20 ... 30
	One level	Standard tray*		3	140	20 ... 30
	2 levels	1-Standard tray* 3-Pastry tray*		1 - 3	140	20 ... 30
	3 levels	1-Standard tray* 3-Pastry tray* 5-Deep tray*		1 - 3 - 5	140	25 ... 35
Small cakes	One level	Standard tray*		3	160	25 ... 35
	One level	Standard tray*		3	150	30 ... 40
	2 levels	1-Pastry tray* 3-Standard tray*		1 - 3	150	35 ... 50
	3 levels	1-Standard tray* 3-Pastry tray* 5-Deep tray*		1 - 3 - 5	150	35 ... 50
Sponge cake	One level	Round springform pan with a diameter of 26 cm on wire grill**		3	160	25 ... 35

Dish	Cooking level number	Accessory to use	Operating mode	Rack position	Temperature (°C)	Cooking time (approx. in min.)
	One level	Round springform pan with a diameter of 26 cm on wire grill**		2	150	30 ... 40
	2 levels	1-Round springform pan with a diameter of 26 cm on wire grill** 4-Round springform pan with a diameter of 26 cm on pastry tray**		1 - 4	150	35 ... 45
Apple pie	One level	Round black metal dish with a diameter of 20 cm on wire grill**		2	180	50 ... 60
	One level	Round black metal dish with a diameter of 20 cm on wire grill**		2	170	50 ... 60
	2 levels	1-Round black metal dish with a diameter of 20 cm on wire grill** 4-Round black metal dish with a diameter of 20 cm on pastry tray**		1 - 4	170	50 ... 60

It is suggested to perform preheating for all foods.
* These accessories may not be supplied with the product.
** These accessories are not supplied with the product. They are commercially available accessories.

Tips for baking cake

- If the cake is too dry, increase the temperature by 10°C and decrease the cooking time.
- If the cake is wet, use less liquid or lower the temperature by 10°C.
- If the cake is too dark on top, place it on a lower rack, lower the temperature and increase the cooking time.
- If cooked well on the inside but sticky on the outside use less liquid, lower the temperature and increase the cooking time.

Tips for baking pastry

- If the pastry is too dry, increase the temperature by 10°C and decrease the cooking time. Dampen the layers of dough with a sauce composed of milk, oil, egg and yoghurt.
- If the pastry takes too long to bake, pay care that the thickness of the pastry you have prepared does not exceed the depth of the tray.
- If the upper side of the pastry gets browned, but the lower part is not cooked, make sure that the amount of

sauce you have used for the pastry is not too much at the bottom of the pastry. Try to scatter the sauce equally between the dough layers and on the top of pastry for an even browning.

i Cook the pastry in accordance with the mode and temperature given in the cooking table. If the bottom part is still not browned enough, place it on one lower rack next time.

Tips for cooking vegetables

- If the vegetable dish runs out of juice and gets too dry, cook it in a pan with a lid instead of a tray. Closed vessels will preserve the juice of the dish.
- If a vegetable dish does not get cooked, boil the vegetables beforehand or prepare them like canned food and put in the oven.

How to operate the grill



Close oven door during grilling.
Hot surfaces may cause burns!

Grilling with electric grill

Food	Accessory to use	Rack position	Recommended temperature (°C)**	Cooking time (approx. in min.)
Fish	Wire grill	4...5	250/max	20...25 min. #
Sliced chicken	Wire grill	4...5	250/max	25...35 min.
Lamb chops	Wire grill	4...5	250/max	20...25 min.
Roast beef	Wire grill	4...5	250/max	25...30 min. #
Veal chops	Wire grill	4...5	250/max	25...30 min. #
Toast bread*	Wire grill	4	250/max	1...3 min.

depending on thickness
*Preheat for 5 minutes
**If the grill temperature of your product cannot be adjusted, the grill will work at the recommended temperature.

Meals in this cooking table are prepared according to EN 60350-1 to make it

easier for control institutes to test the product.

Food	Accessory to use	Rack position	Temperature (°C)	Cooking time (approx. in min.)
Toast bread	Wire grill	4	250/max	1...3 min.
Meatballs (beef) - 12 pieces	Wire grill	4	250/max	25...35 min.

Turn the food after 2/3 of the total grilling time.
It is suggested to perform 5 minutes preheating for all foods broiling.

Switching on the grill

1. Turn the Function knob to the desired grill symbol.
 2. Then, select the desired grilling temperature.
 3. If required, perform a preheating of about 5 minutes.
- » Temperature light turns on.

Switching off the grill

1. Turn the Function knob to Off (top) position.



Foods that are not suitable for grilling carry the risk of fire. Only grill food which is suitable for intensive grilling heat. Do not place the food too far in the back of the grill. This is the hottest area and fatty food may catch fire.

Cooking times table for grilling

7 Maintenance and care

General information

Service life of the product will extend and the possibility of problems will decrease if the product is cleaned at regular intervals.

 Disconnect the product from mains supply before starting maintenance and cleaning works. There is the risk of electric shock!

 Allow the product to cool down before you clean it. Hot surfaces may cause burns!

- Clean the product thoroughly after each use. In this way it will be possible to remove cooking residues more easily, thus avoiding these from burning the next time the appliance is used.
- No special cleaning agents are required for cleaning the product. Use warm water with washing liquid, a soft cloth or sponge to clean the product and wipe it with a dry cloth.
- Always ensure any excess liquid is thoroughly wiped off after cleaning and any spillage is immediately wiped dry.
- Do not use cleaning agents that contain acid or chloride to clean the stainless or inox surfaces and the handle. Use a soft cloth with a liquid detergent (not abrasive) to wipe those parts clean, paying attention to sweep in one direction.

 The surface might get damaged by some detergents or cleaning materials. Do not use aggressive detergents, cleaning powders/creams or any sharp objects during cleaning. Do not use harsh abrasive cleaners or sharp metal scrapers to clean the oven door glass since they can scratch the surface, which may result in shattering of the glass.

 Do not use steam cleaners to clean the appliance as this may cause an electric shock.

Cleaning the hob

Glass ceramic surface

Wipe the glass ceramic surface (vitroceramic) with cold water, paying attention to leave no residual cleaning agents, and dry with a soft clothing. Residues may cause damage on the glass ceramic surface when using the hob for the next time.

Dried residues on the glass ceramic surface (vitroceramic) should under no circumstances be scraped with hook blades, steel wool or similar tools. Remove calcium stains (yellow stains) with commercially available lime remover or a small amount of lime remover such as vinegar or lemon juice.

If the surface is heavily soiled, apply the cleaning agent on a sponge and wait until it is absorbed well. Then, clean the surface of the hob with a damp cloth.

i Sugar-based foods such as thick cream and syrup must be cleaned promptly without waiting the surface to cool down. Otherwise, glass ceramic surface may get damaged permanently.

Slight color fading may occur on coatings or other surfaces in time. This does not affect the operation of the product.

Color fading and stains on the glass ceramic surface is a normal condition, and not a defect.

Cleaning the control panel

Clean the control panel and knobs with a damp cloth and wipe them dry.

i If your product is equipped with buttons/knobs do not remove the control buttons/knobs to clean the control panel.
Control panel may get damaged!

Cleaning the oven

To clean the side wall (Varies depending on the product model.)

(This feature is optional. It may not exist on your product.)

1. Remove the front section of the side rack by pulling it in the opposite direction of the side wall.
2. Remove the side rack completely by pulling it towards you.

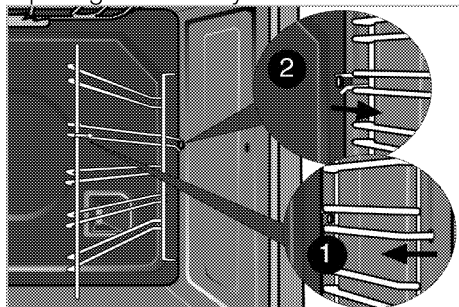

Catalytic walls

(This feature is optional. It may not exist on your product.)

The inner side walls (A) and/or the rear wall (B) of your product may be coated with catalytic enamel. Catalytic walls have a light matte colour and a porous surface. Catalytic walls of the oven should not be cleaned. Thanks to their perforated structure, catalytic surfaces absorb grease and once the surface is filled with grease, they start to shine. In this case, it is recommended to replace the parts.

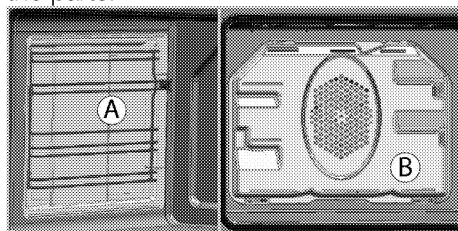

Easy Steam Cleaning

It ensures easy cleaning because the dirt (having waited not for too long) is softened with the steam that forms inside the oven and the water drops condensing on the inner surfaces of the oven.

1. Remove all accessories inside the oven.
2. Pour 500 ml of water into the oven tray and place the tray at the 2nd rack of the oven.

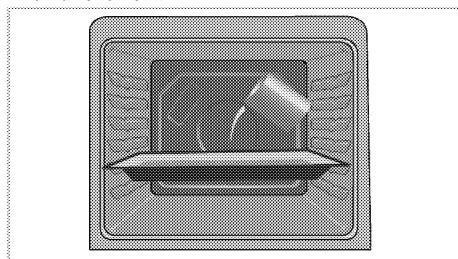

3. Set the oven to easy steam cleaning mode and run at 100°C for 25 minutes.

4. Open the door and wipe the inner surfaces of the oven with a damp sponge or cloth.
5. Use warm water with washing liquid, a soft cloth or sponge to clean the persistent dirt and wipe it with a dry cloth.

i During the easy steam cleaning mode, water that is placed in the tray to soften lightly formed residues/dirt within the oven cavity will evaporate and condense in the oven cavity and inner glass of the oven door, therefore water may drip when the oven door is opened. Wipe away the condensation as soon as the oven door is opened.

Clean oven door

To clean the oven door, use warm water with washing liquid, a soft cloth or sponge to clean the product and wipe it with a dry cloth.

Wipe the glass with vinegar and then rinse it against lime residues that may occur on the oven glass.

i Don't use any harsh abrasive cleaners or sharp metal scrapers for cleaning the oven door. They could scratch the surface and destroy the glass.

Cleaning the oven door

i Do not use harsh abrasive cleaners, metal scrapers, wire wool or bleach materials to clean the oven door and glass.

You can remove your oven door and door glasses to clean them. How to remove the doors and windows is explained in the sections "Removing the oven door" and "Removing the inner glasses of the door". After removing the door inner glasses, clean them using a

dishwashing detergent, warm water and a soft cloth or sponge and dry them with a dry cloth. Wipe the glass with vinegar and then rinse it against lime residues that may occur on the oven glass.

Removing the oven door

1. Open the front door (1).
2. Open the clips at the hinge housing (2) on the right and left hand sides of the front door by pressing them down as illustrated in the figure.

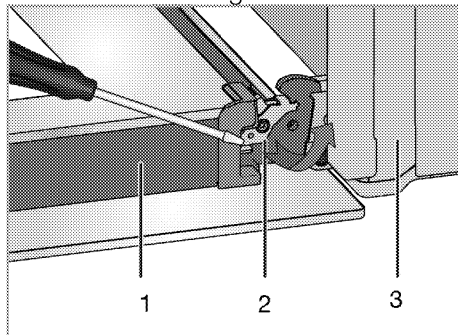

- 1 Door
- 2 Hinge lock(closed position)
- 3 Oven
- 4 Hinge lock(open position)

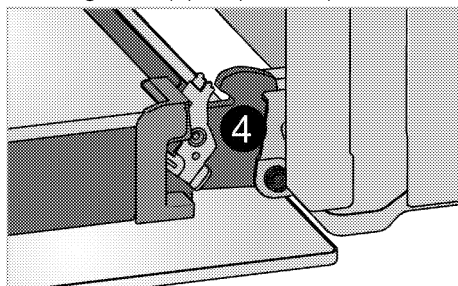

3. Move the front door to half-way.

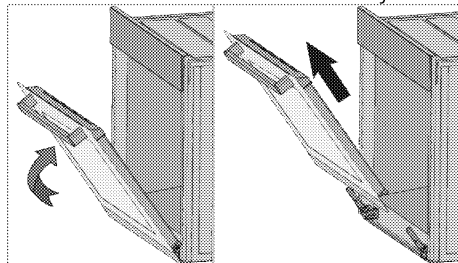

4. Remove the front door by pulling it upwards to release it from the right and left hinges.

i Steps carried out during removing process should be performed in reverse order to install the door. Do not forget to close the clips at the hinge housing when reinstalling the door.

Removing the door inner glass

(This feature is optional. It may not exist on your product.)

The inner glass panel of the oven door can be removed for cleaning.

1. Open the oven door.

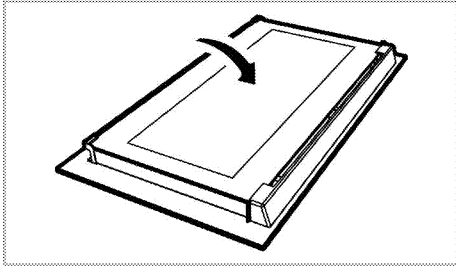

2. Pull towards yourself and remove the plastic part installed to upper section of the front door.

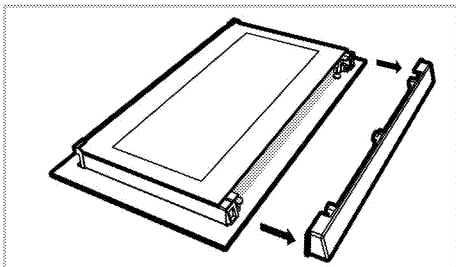

3. As illustrated in figure, raise the innermost glass panel (1) slightly in direction **A** and pull it out in direction **B**.

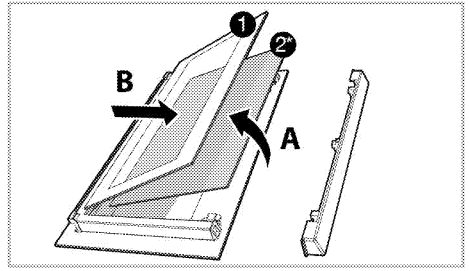

1 Innermost glass panel

2* Inner glass panel (This may not exist on your product.)

4. If your product is equipped with an inner glass panel; repeat the same procedure to remove the inner glass panel (2).

5. The first step to regroup the door is reinstalling inner glass panel (2). Place the chamfered corner of the glass panel so that it will rest in the chamfered corner of the plastic slot. (If your product is equipped with an inner glass panel). Inner glass panel (2) must be installed into the plastic slot close the innermost glass panel (1).

6. When installing the innermost glass panel (1), make sure that the printed side of the panel faces towards the inner glass panel. It is important to seat lower corner of innermost glass panel (1) into the lower plastic slot.

7. Push the plastic part towards the frame until you hear a "click".

Replacing the oven lamp



Before replacing the oven lamp, make sure that the product is disconnected from mains and cooled down in order to avoid the risk of an electrical shock. Hot surfaces may cause burns!

i In this oven, an incandescent lamp with a power of less than 40 W, a height of less than 60 mm, a diameter of less than 30 mm or a halogen lamp with socket type G9, a power of less than 60 W is used. The lamps are suitable for operation at temperatures above 300 °C. Oven lamps can be obtained from Authorised Service Agents or technician with licence.

i Position of lamp might vary from the figure.

i The lamp used in this appliance is not suitable for household room illumination. The intended purpose of this lamp is to assist the user to see foodstuffs.

i The lamps used in this appliance have to withstand extreme physical conditions such as temperatures above 50 °C.

If your oven is equipped with a round lamp:

1. Disconnect the product from mains.

2. Turn the glass cover counter clockwise to remove it.

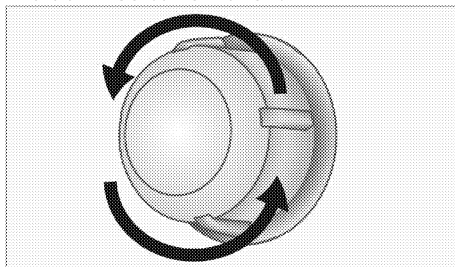

3. If your oven lamp is of type (A) shown in the figure below, remove it by rotating as shown and replace it. If it is of type (B), pull and remove it as shown in the figure and replace it.

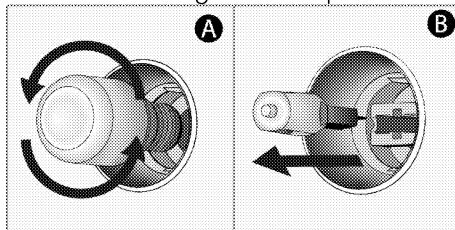

4. Install the glass cover.

8 Troubleshooting

Oven emits steam when it is in use.

- It is normal that steam escapes during operation. >>> *This is not a fault.*

Product emits metal noises while heating and cooling.

- When the metal parts are heated, they may expand and cause noise. >>> *This is not a fault.*

Product does not operate.

- The mains fuse is defective or has tripped. >>> *Check fuses in the fuse box. If necessary, replace or reset them.*
- Product is not plugged into the (grounded) socket. >>> *Check the plug connection.*

Oven light does not work.

- Oven lamp is defective. >>> *Replace oven lamp.*
- Power is cut. >>> *Check if there is power. Check the fuses in the fuse box. If necessary, replace or reset the fuses.*

Oven does not heat.

- Might not be set to a certain cooking function and/or temperature. >>> *Set the oven to a certain cooking function and/or temperature.*
- In models equipped with a timer, the timer is not adjusted. >>> *Adjust the time.* (In products with microwave oven, timer controls only microwave oven.)
- Power is cut. >>> *Check if there is power. Check the fuses in the fuse box. If necessary, replace or reset the fuses.*

(In models with timer) Clock display is blinking or clock symbol is on.

- A previous power outage has occurred. >>> *Adjust the time / Switch of the product and switch it on again.*



Consult the Authorised Service Agent or technician with licence or the dealer where you have purchased the product if you can not remedy the trouble although you have implemented the instructions in this section. Never attempt to repair a defective product yourself.

Arcelik A.S.

Karaağaç Caddesi No:2-6 Sütlüce, 34445, Turkey

Made in TURKEY

Importer in Russia: «BEKO LLC»

Address: Selskaya street, 49, Fedorovskoe village, Pershinskoe rural settlement,
Kirzhach district, Vladimir region, Russian Federation 601021

The manufacture date is included in the serial number of a product specified on rating label, which is located on a product, namely: first two figures of serial number indicate the year of manufacture, and last two – the month. For example, "10-100001-05» indicates that the product was produced in May, 2010.

You can ask for certification number from our Call Center 8-800-200-23-56 The manufacturer reserves the right for making changes in modification, design and specification of an electric device.

beko

Pećnica

Uputstvo za upotrebu

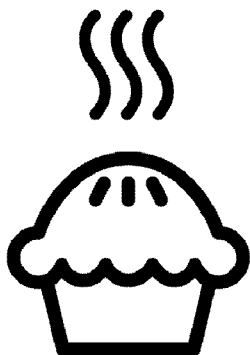

BS



RECIKLIRANI I
RECIKLABILNI PAPIR

Molimo prvo pročitajte ovaj priručnik za korisnika!

Poštovani Korisniče,

Hvala vam što ste izabrali Beko proizvod. Nadamo se da ćete uživati u najboljim rezultatima vašeg proizvoda koji je proizveden pomoću najmodernije tehnologije visoke kvalitete. Stoga, molimo vas pažljivo pročitajte ovaj cijeli priručnik za korisnika i sve druge prateće dokumente prije upotrebe proizvoda i čuvajte ih kao referencu za buduću upotrebu. Ako uručite ovaj proizvod nekom drugom, također mu/joj predajte i ovaj priručnik za korisnika. Slijedite sva upozorenja i informacije u ovom priručniku za korisnika.

Zapamtite da se ovaj priručnik za korisnika može primijeniti i za nekoliko drugih modela. Razlike između modela će biti identifikovane u ovim uputstvima.

Pojašnjenje simbola

Sljedeći simboli su korišteni u ovom priručniku za korisnika:



Važne informacije ili korisni savjeti za upotrebu.



Upozorenje za opasne situacije po pitanju života i imovine.



Upozorenje u vezi elektro šoka.



Upozorenje u vezi rizika od požara.



Upozorenje na vruće površine.



Arçelik A.Ş.
Karaağaç caddesi No:2-6
34445 Sütlüce/Istanbul/TURKEY
Made in TURKEY

**1 Važna uputstva i upozorenja
za sigurnost i okoliš 4**

Opće mjere sigurnosti.....	4
Električna sigurnost	5
Sigurnost proizvoda.....	6
Predviđena upotreba	9
Sigurnost za djecu.....	9
Odlaganje starog proizvoda.....	9
Odlaganje materijala za pakovanje	10

2 Opće informacije 11

Pregled.....	11
Sadržaj pakovanja	12
Tehničke specifikacije	13

3 Instalacija 15

Prije instalacije.....	15
Instalacija i povezivanje	16
Odlaganje starog proizvoda.....	18

4 Priprema 20

Savjeti za uštedu energije.....	20
Prva upotreba	20
Podešavanje vremena	20
Prvo čišćenje uređaja.....	21
Početno zagrijavanje.....	21

**5 Kako koristiti ploču za
kuhanje 22**

Opšte informacije o kuhanju	22
Upotreba ploče za kuhanje.....	23

6 Kako rukovati pećnicom 25

Opće informacije o pečenju, prženju i roštiljanju	25
Kako rukovati električnom pećnicom.....	26
Načini rada.....	26
Upotreba sata pećnice.....	28
Tabela vremena kuhanja	31
Kako rukovati roštiljom	35
Vrijeme pripremanja hrane korištenjem funkcije roštilja	35

7 Održavanje i njega 36

Opšte informacije.....	36
Čišćenje ploče za kuhanje	36
Čišćenje kontrolne ploče	37
Čišćenje pećnice	37
Čišćenje vrata rerne	38
Uklanjanje unutrašnjeg stakla na vratima..	39
Zamjena svjetla u pećnici	40

8 Rješavanje problema 41

1 Važna uputstva i upozorenja za sigurnost i okoliš

Ovaj odjeljak sadrži sigurnosna uputstva koja će vam pomoći da se zaštitite od rizika od lične povrede ili oštećenja imovine. Ne pridržavanje ovih uputstava će poništiti svaku garanciju.

Opće mjere sigurnosti

- Ovaj uređaj mogu koristiti djeca dobi od 8 godina i starija kao i osobe sa reduciranim fizičkim, čulnim ili mentalnim sposobnostima ili sa nedostatkom iskustva i znanja ukoliko im je obezbijeđen nadzor ili uputstvo u vezi upotrebe uređaja na bezbjedan način i razumijevanja opasnosti koje mogu biti uključene. Djeca se ne smiju igrati sa uređajem. Djeca bez nadzora ne smiju obavljati radnje oko čišćenja i održavanja.
- Uređaj nije namijenjen za upotrebu od strane osoba (uključujući djecu) sa smanjenim fizičkim, osjetilnim ili mentalnim sposobnostima ili s nedostatkom iskustva i znanja, osim ako su pod nadzorom ili ako su instruirani po pitanju upotrebe uređaja.

Djeca koju nadgledate ne smiju se igrati s uređajem.

- Ako je proizvod uručen nekom drugom za ličnu upotrebu ili da se koristi kao rabljeni proizvod, takođe treba uručiti priručnik za korisnika, oznake proizvoda i druge relevantne dokumente kao i dijelove proizvoda .
- Nikada ne postavljajte proizvod na tepih-pokrivene podove. U spurotnom, manjak protoka zraka ispod proizvoda će prouzrokovati pregrijavanje električnih dijelova. To će prouzrokovati probleme s vašim proizvodom.
- Postupke ugradnje i opravke uvijek moraju izvoditi ovlašteni serviseri. Proizvođač se neće držati odgovornim za oštećenja nastala usljed procedura koje su izvodile neovlaštene osobe što takođe može prouzrokovati da garancija bude nevažeća. Prije ugradnje, pažljivo pročitajte uputstva.

- Nemojte koristiti uređaj ukoliko je u kvaru ili ako na njemu ima vidljivih oštećenja.
- Uvjerite se da su funkcijske tipke proizvoda isključene nakon svake upotrebe.

Električna sigurnost

- Ukoliko proizvod ima grešku, ne bi trebalo njim rukovati dok se greška ne popravi od strane zastupnika iz ovlaštenog servisa. Postoji rizik od elektro šoka!
- Proizvod spojite samo na uzemljeni izlaz/vod s naponom i zaštitu kao što je specificirano u odjeljku "Tehničke specifikacije". Neka uzemljenje izvrši kvalifikovani električar dok se proizvod koristi sa ili bez transformatora. Naša kompanija neće biti odgovorna za bilo kakve probleme nastale zbog toga što proizvod nije bio uzemljen u skladu sa lokalnim regulativama.
- Nikada ne perite proizvod poljevanjem ili posipanjem vode po njemu! Postoji rizik od elektro šoka!
- Proizvod mora biti iskopčan za vrijeme ugradnje, održavanja, čišćenja i popravke.
- Ako je napojni kabal za priključivanje proizvoda oštećen, isti se mora zamijeniti od strane proizvođača, njegovog zastupnika ili sličnih kvalifikovanih osoba da bi se izbjegli neželjeni rizici.
- Koristite samo kabal za priključivanje koji je specificiran u odjeljku "Tehničke specifikacije".
- Uređaj mora biti ugrađen tako da se može u potpunosti iskopčati sa mreže. Separacija mora biti obezbijedena bilo pomoću glavnog utikača, bilo pomoću sklopke ugrađene u fiksnu električnu instalaciju, u skladu sa konstrukcionim propisima.
- Stražnja površina pećnice zagrije se prilikom korištenja. Budite sigurni da električni priključak nema kontakta sa stražnjom površinom; u suprotnom, spoj se može oštetiti.
- Nemojte dozvoliti da se napojni kabal zaglavi između vrata pećnice i okvira i nemojte voditi kabal preko toplih površina. U suprotnom,

izolacija kabla bi se mogla istopiti što može izazvati požar kao rezultat kratkog spoja.

- Sve radove na električnoj opremi i sistemima trebaju izvoditi samo ovlaštene i kvalificirane osobe.
- U slučaju bilo kakvog oštećenja, isključite uređaj i iskopčajte ga sa napajanja. Da biste ovo uradili, isključite osigurač u kući.
- Provjerite da je jačina osigurača kompatibilna sa vašim proizvodom.

Sigurnost proizvoda

- **UPOZORENJE:** Uređaj i njegovi dostupni dijelovi postaju vrela za vrijeme upotrebe. Potrebno je voditi računa da bi se izbjeglo dodirivanje grijnih elemenata. Djecu mlađu od 8 godina treba držati dalje od uređaja ukoliko nisu pod stalnim nadzorom.
- Osobe čije su prosudbe ili koordinacija smanjene pod uticajem alkohola i/ili droga ne smiju koristiti uređaj.
- Budite oprezni kada koristite alkoholna pića u vašem posuđu. Alkohol isparava na

visokim temperaturama i može izazvati požar jer se zapali kada stupi u kontakt sa vrućim površinama.

- Nemojte stavljati nikakve zapaljive materijale u blizini proizvoda jer i bočne strane mogu postati vruće tokom upotrebe.
- Uređaj postaje vruć za vrijeme upotrebe. Potrebno je voditi računa da bi se izbjeglo dodirivanje grijnih elemenata unutar pećnice.
- Držite sve otvore za ventilaciju očišćenim od prepreka.
- Nemojte zagrijavati zatvorene konzerve niti staklene posude u pećnici. Pritisak koji se može stvoriti u tim konzervama/posudama može dovesti do njihovog pucanja.
- Nemojte stavljati pladnjeve za pečenje, posuđe ili aluminijsku foliju direktno na dno pećnice. Akumuliranje toplote moglo bi uzrokovati oštećenja na dnu pećnice.
- Nemojte koristiti gruba abrazivna sredstva za čišćenje ili oštre metalne strugače da čistite staklo na vratima pećnice jer oni mogu

izgrebati površinu, što može rezultirati lomom na staklu.

- Nemojte koristiti čistače na paru da čistite uređaj jer bi to moglo prouzrokovati strujni udar.
- (Varira u ovisnosti od modela proizvoda.)

Ispravno postavljanje žičanog nosača i pladnja na stalke za rešetku

Važno je da se žičana rešetka i/ili pladanj postave ispravno na stalak. Umetnite žičanu rešetku ili pladanj između 2 tračnice i osigurajte da bude uravnoteženo prije nego stavite hranu na to (Molimo pogledajte slijedeću sliku).

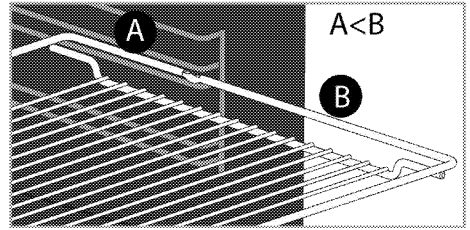
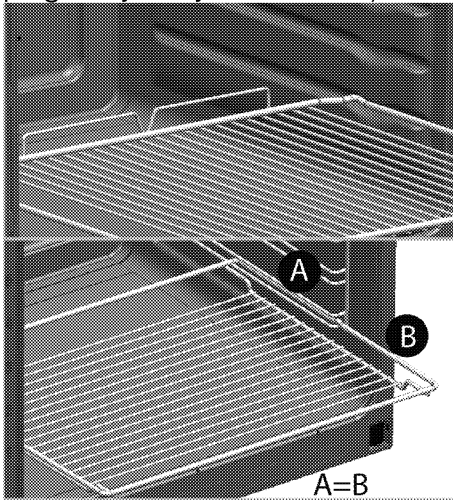

- Nemojte koristiti proizvod ukoliko je staklo na prednjim vratima uklonjeno ili slomljeno.
- Uvijek koristite rukavice za pećnicu otporne na vrućinu kada stavljate ili uklanjate posuđe u/iz vrele pećnice.
- Postavite papir za pečenje u posudu za kuhanje ili na dodatnu opremu pećnice (pladanj, žičanu rešetku itd.) zajedno s hranom i potom ubacite sve u prethodno zagrijanu pećnicu. Uklonite višak dijelova papira za pečenje koji se preljeva izvan dodatne opreme ili posude da bi se spriječio rizik dodirivanja grijnih elemenata pećnice. Nikada ne koristite papir za pečenje na radnoj temperaturi koja je viša od naznačene vrijednosti za papir za pečenje. Nemojte stavljati papir za pečenje direktno na bazu pećnice.
- **UPOZORENJE:** Prije zamjene lampice, uvjerite se da je napojni kabl uređaja

isključen iz utičnice ili da je automatska sklopka

isključena kako biste izbjegli mogućnost strujnog udara.

- Uređaj ne smije biti instaliran iza dekorativnih vrata kako bi se izbjeglo pregrijavanje.
- Proizvod se mora postaviti direktno na pod. Ne smije se stavljati na neku podlogu ili postolje.
- **UPOZORENJE:** Kuhanje bez nadzora na ploči za kuhanje sa masnoćom ili uljem može biti opasno i može izazvati požar. NIKADA ne pokušavajte gasiti vatru vodom, nego isključite uređaj i potom pokrijte plamen sa, npr. poklopcem ili dekom.
- **OPREZ:** Proces kuhanja se mora nadgledati. Kratkotrajni proces kuhanja se mora neprestano nadgledati.
- **UPOZORENJE:** Opasnost od požara: Nemojte ostavljati stvari na površinama za kuhanje.
- **UPOZORENJE:** Ako je površina napuknuta, isključite uređaj kako biste izbjegli mogućnost strujnog udara.
- U slučaju napuknuća stakla na ploči za kuhanje: Odmah zatvorite sve gorionike i sve

električne grijaće elemente i isključite napajanje na uređaju. Nemojte dodirivati površine na uređaju. Nemojte koristiti uređaj.

- Uređaj nije namijenjen za rukovanje sredstvima nekog eksternog programatora ili posebnog sistema daljinskog upravljača.
- Pritisak isparavanja koji nastaje usljed vlažnosti na površini ploče za kuhanje ili na dnu posude može prouzrokovati pomjeranje posude. Stoga pazite da površina ploče i dno lonaca budu suhi.
- **UPOZORENJE:** Koristite samo štitnike ploče za kuhanje dizajnirane od strane proizvođača uređaja za kuhanje ili one koji su naznačeni od strane proizvođača uređaja u uputstvima za upotrebu kao pogodne za štitnike ploče za kuhanje, ugrađene u uređaj. Korištenje neadekvatnih štitnika može prouzrokovati nezgode.

Za sigurnost od požara na proizvodu;

- Provjerite da li utikač odgovara utičnici kao i to da ne uzrokuje iskrenje.
- Ne upotrebljavajte oštećen ili sječen ili produžni kabal osim originalnog kabla.
- Budite sigurni da tečnost ili vlaga na utičnici ne dospiju u proizvod preko utikača.

Predviđena upotreba

- Ovaj proizvod je dizajniran za upotrebu u domaćinstvu. Komercijalna upotreba nije dopuštena.
- **OPREZ:** Ovaj uređaj je samo za kuhanje. On se ne smije koristiti u druge svrhe, na primjer grijanje prostorije.
- Uređaj se ne smije koristiti za zagrijavanje tanjira ispod roštilja, sušenje peškira ili krpa itd. vješanjem istih na ručkama kao ni u svrhu zagrijavanja.
- Proizvođač nije odgovoran za bilo kakve štete uzrokovane nepropisnim korištenjem ili greškama pri rukovanju.
- Uređaj se može koristiti za odmrzavanje, pečenje, prženje i roštiljanje hrane.

Sigurnost za djecu

- **UPOZORENJE:** Pristupačni dijelovi mogu postati vrući tokom upotrebe. Malu djecu treba držati dalje od uređaja.
- Ambalažni materijali mogu predstavljati opasnost za djecu. Držite ambalažne materijale dalje od dohvata djece. Molimo odložite sve dijelove pakovanja i skladište sa ekološkim propisima.
- Električni proizvodi predstavljaju opasnost za djecu. Držite djecu dalje od proizvoda kada je on u funkciji i nemojte dozvoliti djeci da se igraju s tim proizvodom.
- Ne ostavljajte iznad uređaja bilo kakve predmete koje djeca mogu dosegnuti.
- Kada su vrata otvorena, nemojte stavljati bilo kakve teške predmete na njih i ne dajte djeci da sjedaju na njih. Vrata se mogu oboriti ili se mogu oštetiti šarke na vratima.

Odlaganje starog proizvoda

Usklađenost sa WEEE Direktivom i odlaganje otpadnog proizvoda:



Ovaj proizvod je u skladu sa EU WEEE Direktivom (2012/19/EU). Ovaj proizvod posjeduje klasifikacijski simbol za otpadnu električnu i elektroničku opremu (WEEE).

Ovaj proizvod je proizveden od visoko kvalitetnih dijelova koji se mogu ponovo upotrijebiti i koji su pogodni za recikliranje. Nemojte odlagati otpadni proizvod s običnim kućnim i drugim otpadima čiji je vijeka trajanja prošao. Odnosite taj otpad na odlagalište za reciklažu električne i elektroničke opreme. Molimo vas posavjetujte se sa lokalnim institucijama da saznate gdje se nalaze ova odlagališta.

Usklađenost sa RoHS Direktivom:

Proizvod koji ste kupili je u skladu sa EU RoHS Direktivom (2011/65/EU). On ne sadrži nikakve štetne i zabranjene materijale specificirane u ovoj Direktivi.

Odlaganje materijala za pakovanje

- Materijal za pakovanje predstavlja opasnost po djecu. Čuvajte materijal za pakovanje na sigurnom mjestu van dohvata djece. Materijali za pakovanje ovog proizvoda napravljeni su od reciklirajućeg materijala. Pravilno ih odložite i sortirajte ih u skladu sa uputstvima za reciklažu otpada. Nemojte ih odlagati zajedno sa običnim kućnim otpadom.

2 Opće informacije

Pregled

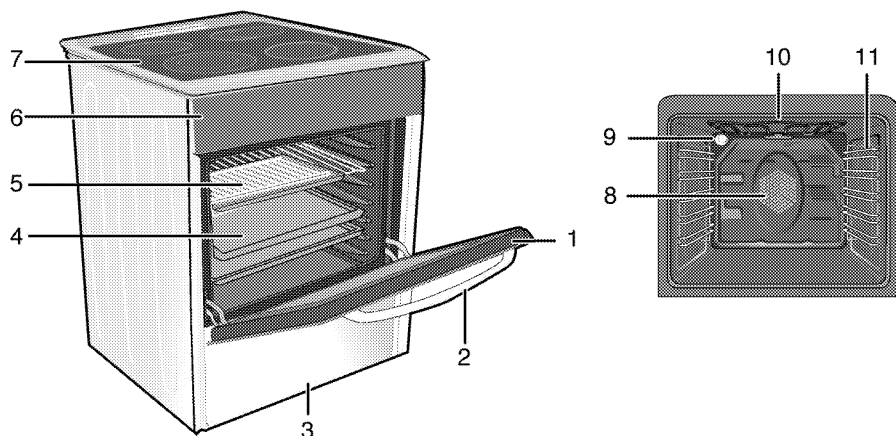

- | | |
|---------------------|---|
| 1 Prednja vrata | 7 Ploča gorionika |
| 2 Drška | 8 Motor ventilatora (iza čelične ploče) |
| 3 Donja ladica | 9 Lampa |
| 4 Pladanj | 10 Grijni element roštilja |
| 5 Žičani nosač | 11 Položaji police |
| 6 Upravljačka ploča | |

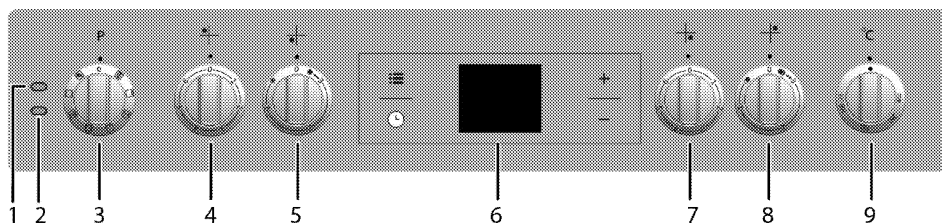

- | | |
|---|------------------------|
| 1 Lampica upozorenja | 9 Termostatska sklopka |
| 2 Termostatska lampa | |
| 3 Funkcijska sklopka | |
| 4 Ploča za kuhanje sa jednim kolom
Stražnji lijevi | |
| 5 Ploča za kuhanje sa dva kola
Prednji lijevi | |
| 6 Digitalni mjerac vremena | |
| 7 Ploča za kuhanje sa jednim kolom
Prednji desni | |
| 8 Proširena ploča za kuhanje
Stražnji desni | |

Sadržaj pakovanja

i Isporučeni pribor se može razlikovati ovisno od modela proizvoda. Svaki komad dodatnog pribora koji je opisan u priručniku za korisnika ne mora biti isporučen uz vaš proizvod.

1. Uputstvo za upotrebu

2. Standardni pladanj

Upotrebljava se za peciva, zamrznutu hranu i velike pečenice.

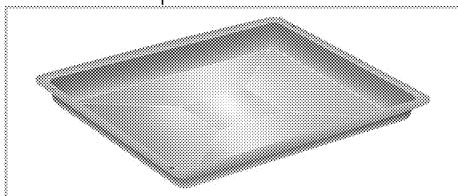

3. Pladanj za tijesto

Upotrebljava se za peciva poput suhих kolačića i biskvita.

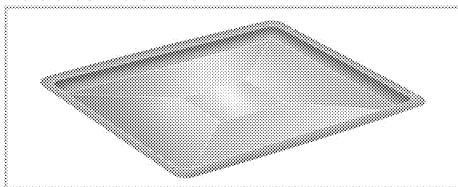

4. Rešetka roštilja

Upotrebljava se za prženje i za postavljanje hrane koju treba peći, pržiti ili kuhati u loncu na željenoj polici.

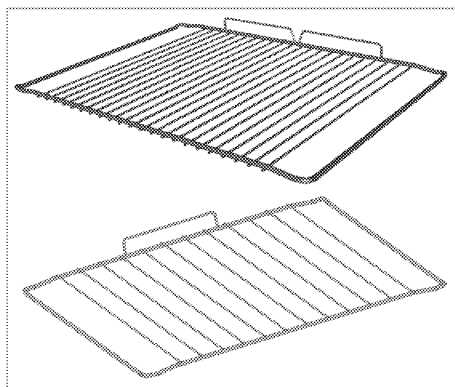
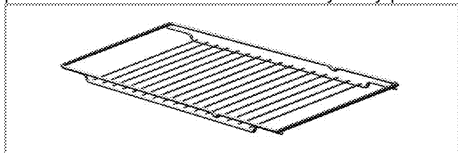

5. Ispravno postavljanje žičanog nosača i pladnja na teleskopske stalke

(Ova funkcija je opcionalna. Ona se možda neće nalaziti na vašem proizvodu.)

Teleskopski stalci omogućavaju vam da lako postavite i uklonite pladnjeve i žičani nosač.

Kada koristite pladnjeve i žičani nosač sa teleskopskim stalcima, osigurajte da zakačke na stražnjem odjeljku teleskopskog stalka stoje nasuprot rubova žičanog nosača i pladnja.

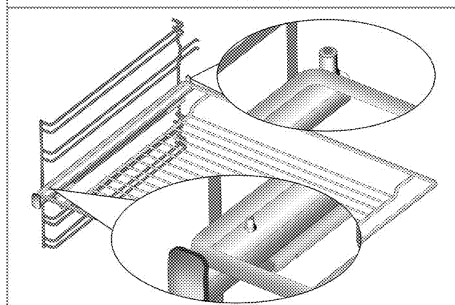
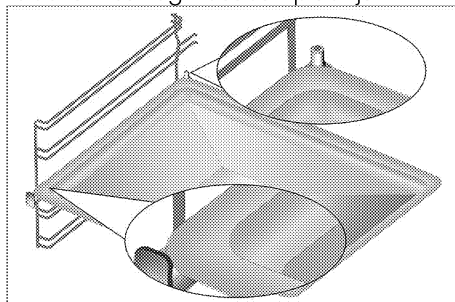

Tehničke specifikacije

OPŠTI	
Vanjske dimenzije (visina/širina/dubina)	850 mm/600 mm/600 mm
Napon/frekvencija	220-240 V 1N ~ / 380-415 V 3N ~ 50/60 Hz
Ukupna potrošnja električne energije	9,9 kW
Vrsta kabla/poprečni presjek	min.H05VV-FG 3 x 4 mm ² / 5 x 2,5 mm ²
PLOČA ZA KUHANJE	
Gorionici	
Stražnji lijevi	Ploča za kuhanje sa jednim kolom
Dimenzije	140 mm
Snaga	1200 W
Prednji lijevi	Ploča za kuhanje sa dva kola
Dimenzije	210/120 mm
Snaga	2200/750 W
Prednji desni	Ploča za kuhanje sa jednim kolom
Dimenzije	180 mm
Snaga	1700 W
Stražnji desni	Proširena ploča za kuhanje
Dimenzije	170/265 mm
Snaga	1500/2400 W
PEĆNICA/ROŠTILJ	
Glavna pećnica	Multifunkcijska pećnica
Unutrašnja lampica	15-25 W
Potrošnja električne energije roštilja	2,2 kW

Osnove: Informacije o električnim pećnicama na etiketi o energiji date su u skladu sa EN 60350-1 / IEC 60350-1 standardima. Te vrijednosti su determinirane pod standardnim opterećenjem sa donjim-gornjim grijačima ili funkcijama zagrijavanja potpomognutim ventilatorom (ukoliko postoje). Klasa energetske efikasnosti je determinirana u skladu sa slijedećim prioritetima što zavisi od toga da li relevantne funkcije postoje na uređaju ili ne. 1-Kuhanje uz eco-ventilator, 2- Turbo sporo kuhanje, 3- Turbo kuhanje, 4- Zagrijavanje donje/gornje površine potpomognuto ventilatorom, 5- Zagrijavanje donje i gornje površine.

i Tehničke specifikacije su podložne izmjenama bez prethodne obavijesti kako bi se poboljšao kvalitet uređaja.

i Slike u ovom priručniku su shematske i moguće je da se ne podudaraju tačno s vašim uređajem.

i vrijednosti prikazane na naljepnicama uređaja ili u priloženoj dokumentaciji postignute su u laboratorijskim uvjetima u skladu sa relevantnim standardima. Ovisno o uvjetima okoline i rada uređaja, ove vrijednosti mogu varirati.

3 Instalacija

Proizvod mora biti ugrađen od strane ovlaštene osobe u skladu sa propisima koji su na snazi. U suprotnom, garancija će postati nevažeća. Proizvođač se neće držati odgovornim za oštećenja nastala usljed procedura koje su izvodile neovlaštene osobe i garancija može biti nevažeća.

i Priprema lokacije i elektro instalacije za ovaj proizvod je u nadležnosti korisnika.

! Prilikom instalacije, uređaj mora biti spojen u skladu sa svim lokalnim propisima o plinskim i/ili električnim instalacijama.

! Prije instalacije, izvršiti vizuelno provjeru da li na proizvodu ima bilo kakvih nedostataka. Ako da, nemojte vršiti instalaciju. Oštećeni proizvodi predstavljaju rizik za vašu sigurnost.

Prije instalacije

Da bi se osiguralo da ispod uređaja postoji prostor za zrak, što je od ključnog značaja, preporučujemo da se uređaj postavi na čvrstu podlogu i da nožice ne utonu u tepih ili bilo kakav meki prekrivač za pod. Kuhinjski pod mora biti takav da može podnositi težinu uređaja i dodatnu težinu posuđa i pribora za kuhanje i hrane.

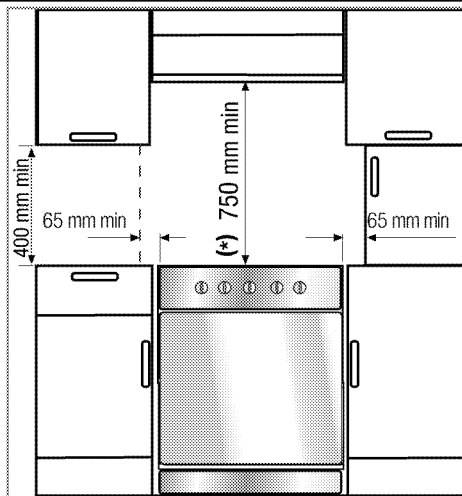

- Uređaj odgovara klasi uređaja 1, tj. može se postavljati sa stražnjim dijelom i **jednom** stranom uz kuhinjske zidove, kuhinjski namještaj ili opremu bilo koje veličine. Kuhinjski namještaj ili oprema sa **druge** strane mogu biti samo iste veličine ili manji.
- Može se koristiti uz ormariće sa obje strane, ali da bi se ostvarila minimalna udaljenost od 400mm iznad nivoa ploče za kuhanje, ostavite zazor sa strane od 65mm između uređaja i zida, pregrade ili visokog plakara.
- Može se koristiti i kao samostojeći uređaj. Omogućite minimalnu razdaljinu od 750 mm iznad površine ploče za kuhanje.
- (*) Kada je potrebno ugraditi kuhinjsku napu iznad štednjaka, pogledajte priložena uputstva od proizvođača kuhinjske nape za pravilno određivanje visine ugradnje. Ako nije definirana bilo koja veličina u priručniku za nape, ta visina treba biti najmanje 650 mm.
- Kuhinjski namještaj koj se postavlja pored uređaja mora biti otporan na toplotu (minimalno 100 °C).

Sigurnosni lanac

Ako vaš proizvod ima 2 sigurnosna lanca;

Uređaj se mora osigurati od neuravnoteženosti korištenjem dva sigurnosna lanca koji se isporučuju uz pećnicu.

Pričvrstite kuku (1) koristeći odgovarajući klin na kuhinjski zid (6) i povežite sigurnosni lanac (3) na kuku pomoću mehanizma za zaključavanje (2).

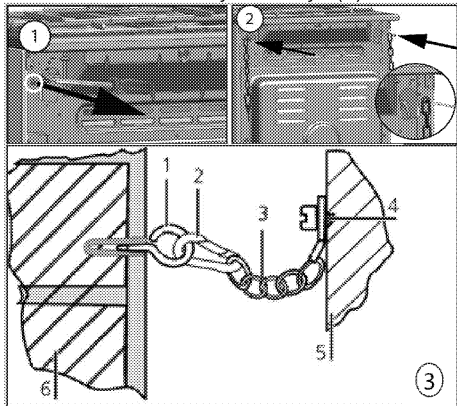

- 1 Kuka za stabilnost
- 2 Mehanizam za zaključavanje
- 3 Sigurnosni lanac
- 4 Čvrsto pričvrstite lanac na stražnji dio štednjaka
- 5 Stražnji dio štednjaka
- 6 Kuhinjski zid

Ako vaš proizvod ima 1 sigurnosni lanac;

Uređaj se mora osigurati od neuravnoteženosti korištenjem isporučenog jednog sigurnosnog lanca na vašoj pećnici.

Slijedite dolje navedene korake koji su dati na slici da biste pričvrstili sigurnosni lanac na vašem proizvodu.

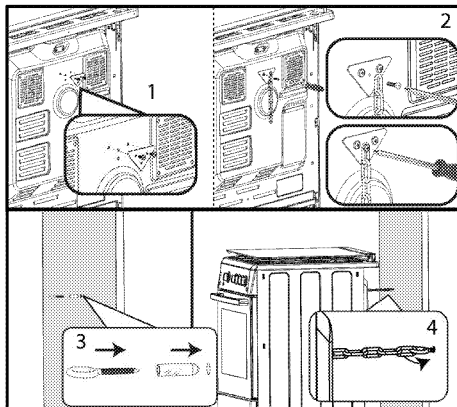

- i** Lanac za stabilnost treba biti kratak koliko god je to praktično moguće kako bi se izbjeglo naginjanje pećnice prema naprijed i dijagonalno da bi se izbjeglo naginjanje pećnice na stranu.

Lanac za stabilnost štednjaka za štednjake koji nisu dizajnirani sa prorezom za konzolno pričvršćivanje.

Instalacija i povezivanje

Proizvod se isključivo može instalirati i priključiti u skladu sa statutarnim pravilima instalacije.

- i** Nemojte instalirati proizvod pored frižidera ili zamrzivača. Toplota koju emitira vaš proizvod će povećati potrošnju energije uređaja za rashlađivanje.

- Proizvod trebaju prenositi najmanje dvije osobe.
- Proizvod se mora postaviti direktno na pod. Ne smije se stavljati na neku podlogu ili postolje.

- i** Ne koristite vrata i/ili ručku da biste prenosili ili premještali ovaj proizvod. Vrata, ručka ili baglame se mogu oštetiti.

Električno spajanje

Priključite proizvod na uzemljenu utičnicu/vod koji su zaštićeni

minijaturnom automatskom sklopkom odgovarajućeg kapaciteta kao što je navedeno u tabeli "Tehničke specifikacije". Neka uzemljenje uradi kvalifikovani električar dok se proizvod koristi sa ili bez transformatora. Naša kompanija neće biti odgovorna za bilo kakva oštećenja koja mogu nastati zbog korištenja proizvoda bez uzemljenja u skladu s lokalnim propisima.



Uređaj mora biti spojen na napojnu mrežu samo od strane ovlaštene i kvalifikovane osobe. Period garancije za proizvod počinje samo nakon ispravno izvršene instalacije. Proizvođač se neće držati odgovornim za oštećenja nastala usljed procedura koje su izvodile neovlaštene osobe.



Kabal za napajanje se ne smije pritiskati, savijati ili gnječiti, niti doći u kontakt sa vrućim dijelovima na proizvodu. Oštećeni kabal za napajanje se mora zamijeniti od strane kvalifikovanog električara. U suprotnom, postoji rizik od elektro šoka, kratkog spoja ili požara!

Podaci napojnog voda moraju odgovarati podacima navedenim na etiketi o tipu proizvoda. Pločica sa podacima o napajanju može se vidjeti kada se otvore vrata ili donji poklopac ili se nalazi na stražnjem zidu jedinice, ovisno o tipu jedinice. Napojni kabal vašeg proizvoda se mora slagati sa vrijednostima iz tabele "Tehničke specifikacije".



Prije započinjanja bilo kakvog rada na električnim instalacijama, iskopčajte uređaj iz napajanja. Postoji rizik od elektro šoka!

Spajanje napojnog kabla



Dok obavljate spajanje žica, morate se pridržavati nacionalnih/lokalnih propisa o električnoj energiji i morate koristiti odgovarajuću utičnicu/vod i utikač za pećnicu. U slučaju da su energetska ograničenja proizvoda izvan trenutnog kapaciteta nosivosti utikača i utičnice/voda, proizvod se mora spojiti direktno preko fiksne električne instalacije, bez korištenja utikača i utičnice/voda.

1. Ako napojni kabal nije isporučen uz vaš proizvod,

napojni kabal koji odaberete iz tabele (*Tehničke specifikacije, Stranica 13*) u skladu sa elektro instalacijama u vašem domu mora biti spojen na vaš proizvod slijedeći uputstva u dijagramu kablova. Nije moguće prekinuti sve polove u izvoru napajanja, jedinica prekida s minimalno 3 mm kontaktnog zazora (osigurači, prekidači linijske sigurnosti, kontaktori) mora biti spojena i svi polovi ove jedinice prekida moraju biti u blizini (ne iznad) proizvoda u skladu sa IEE direktivama. Ne pokoravanje ovim uputstvima može prouzrokovati probleme u radu i učiniti nevažećom garanciju za proizvod.



Preporučuje se dodatna zaštita putem prekidača strujnog kola zaostale električne energije.

2. Otvorite odvijačem poklopac priključnog bloka.
3. Umetnite napojni kabal kroz obujmicu za kabal ispod priključka i pričvrstite

ga na glavno tijelo s integrisanim vijkom na komponenti obujmice za kabal.

4. Povežite kablove prema priloženom dijagramu.

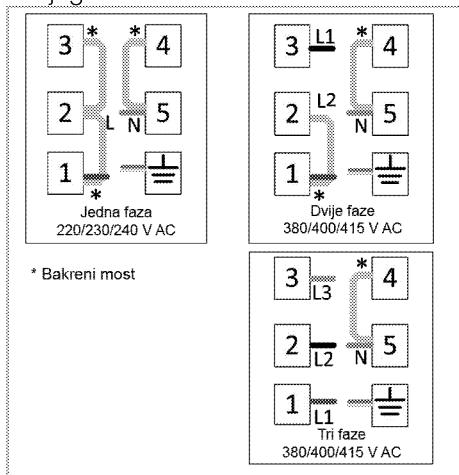

5. Nakon što ste završili spajanje žica, zatvorite poklopac priključnog bloka.

6. Vodite napojni kabal tako da ne dođe u kontakt s proizvodom i da ne bude prigriječen između proizvoda i zida.

i Napojni kabal ne smije biti duži od 2 m iz sigurnosnih razloga.

- Gurnite proizvod prema kuhinjskom zidu.

• Podešavanje nožica pećnice

Vibriranje tokom kuhanja može prouzrokovati pomjeranje posuda za kuhanje. Ova opasna situacija se može izbjeći ukoliko je proizvod ravan i balansiran.

Radi vaše vlastite sigurnosti molimo osigurajte da je proizvod ravan tako što ćete podesiti njegove nožice na dnu okrećući ih lijevo ili desno i poravnajte sa radnom pločom.

Za proizvode sa ventilatorom za hlađenje (Ona se možda neće nalaziti na vašem proizvodu.)

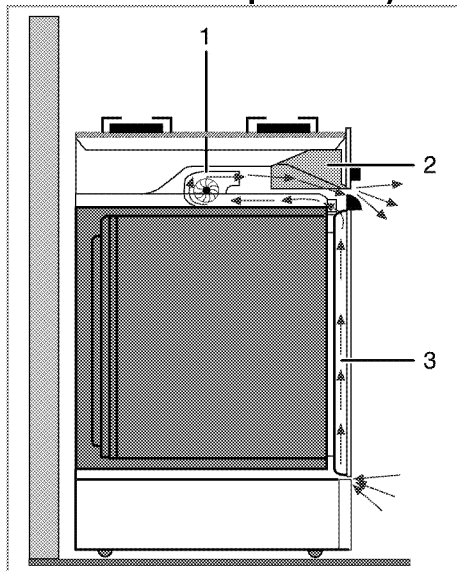

1 Ventilator za hlađenje

2 Upravljačka ploča

3 Vrata

Ventilator za hlađenje hladi i kontrolnu ploču i prednju stranu uređaja.

i Ventilator za hlađenje nastavlja s radom tokom 20 - 30 minuta nakon što se pećnica isključi.

Završna provjera

1. Ponovo spojite proizvod na električnu mrežu.

2. Provjerite električne funkcije.

Odlaganje starog proizvoda.

- Sačuvajte originalnu kutiju u koju je proizvod bio upakovan i transportujte proizvod u istoj. Slijedite uputstva na kutiji. Ukoliko nemate originalnu kutiju, upakujte proizvod u zaštitnu foliju sa zračnim mjehurićima ili debelu kartonsku ambalažu i čvrsto omotajte ljepljivom trakom.

- Da biste spriječili da žičana polica i pleh oštete vrata pećnice, stavite komad kartona sa unutrašnje strane vrata pećnice, tako da odgovara položaju pleha. Zalijepite trakom vrata pećnice za bočne zidove.
- Ne koristite vrata ili ručku da biste podizali ili premještali ovaj proizvod.

- i** Nemojte stavljati nikakve predmete na proizvod i pomjerajte ga u uspravnom položaju.
- i** Provjerite generalno izgled vašeg proizvoda radi bilo kakvih oštećenja koja su se mogla desiti tokom transporta.

4 Priprema

Savjeti za uštedu energije

Sljedeće informacije će vam pomoći da koristite vaš uređaj na ekološki način i da štedite energiju:

- Koristite emajlirane plehove ili plehove tamne boje u pećnici jer će time biti ostvaren bolji prenos toplote.
- Prilikom pripremanja jela, izvršite operacije prethodnog zagrijavanja ako se to savjetuje u korisničkom priručniku ili uputama za kuhanje.
- Ne otvarajte često vrata pećnice za vrijeme kuhanja.
- Pokušajte istovremeno kuhati (spremati) više od jednog jela u pećnici kad god je to moguće. Možete kuhati tako što ćete staviti dvije posude za kuhanje na rešetku roštilja.
- Spremajte više jela jedno za drugim. Pećnica će već biti vruća.
- Možete uštediti energiju tako što ćete isključiti vašu pećnicu par minuta prije isteka vremena kuhanja. Ne otvarajte vrata pećnice.
- Odmrznite zamrznuta jela prije kuhanja.
- Koristite šerpe/tave sa poklopcima za kuhanje. Ukoliko nema poklopca, potrošnja energije se može uvećati 4 puta.
- Odaberite gorionik koji je prikladan za veličinu dna posude koju ćete koristiti za kuhanje. Uvijek odaberite ispravno veličinu posude za spremanje vaših jela. Veće posude zahtijevaju više energije.
- Vodite računa o tome da koristite posude sa ravnim dnom kada kuhate na električnoj ploči za kuhanje. Posude sa debelim dnom će omogućiti bolju provodljivost toplote. Možete postići uštedu energije i do 1/3.

- Posude za kuhanje moraju biti kompatibilne sa zonama kuhanja. Dno posude ne smije biti manje nego što je kolo na kojem će se kuhati.
- Održavajte zone kuhanja i dna posuda čistim. Prljavština će umanjiti provodljivost toplote između zona kuhanja i dna posude.
- Za duža kuhanja, isključite zonu kuhanja 5 ili 10 minuta prije isteka vremena kuhanja. Možete postići uštedu energije i do 20% koristeći preostalu toplotu.
- Informacije o energetskej efikasnosti prema EU 66/2014 mogu se pronaći na karti proizvođača uz proizvod.

Prva upotreba

Podešavanje vremena

- i** Dok vršite bilo kakva podešavanja, odgovarajući simboli na displeju će treptati.

Nakon što ste prvi put uključili rernu, pritisnite tipke **+/-** da podesite vrijeme u toku dana.

- i** Za modele s kontrolnom na dodir, prvo **≡** dodirnite i zatim koristite **+ / -** da biste podesili vrijeme tokom dana.

Potvrdite postavku dodiranjem simbola **⌚** i sačekajte 4 sekunde bez dodirivanja bilo koje tipke.

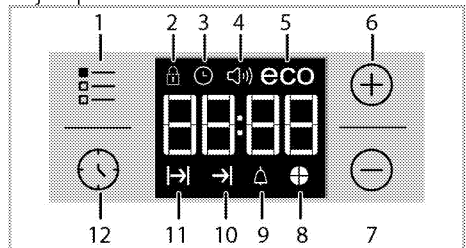

- 1 Tipka za podešavanje
- 2 Simbol zaključane tipke

- 3 Simbol sata
 - 4 Simbol jačine alarma *
 - 5 Simbol za Eco režim rada
 - 6 Tipka plus
 - 7 Tipka minus
 - 8 Simbol za vrijeme
 - 9 Simbol za alarm
 - 10 Simbol vremena završetka kuhanja*
 - 11 Simbol vremena kuhanja
 - 12 Taster za program
- * (Varira u ovisnosti od modela proizvoda.)

i Ako inicijalno vrijeme nije podešeno, sat će početi s odbrojavanjem počevši od 12:00 i prikazaće se simbol 🕒. Kad vrijeme bude podešeno, taj će simbol nestati.

i Trenutne postavke vremena će se poništiti u slučaju prekida u napajanju. Potrebno ih je ponovo podesiti.

Prvo čišćenje uređaja

i Neki deterdženti i materijali za čišćenje mogu izazvati oštećenja na površini. Nemojte koristiti agresivne deterdžente, praškove/kreme za čišćenje ili bilo kakve oštre predmete dok čistite.

1. Uklonite sve materijale korištene za pakovanje
2. Obrišite površine uređaja vlažnom krpom ili spužvom i posušite krpom.

Početno zagrijavanje

Uključite uređaj da grije nekih 30 minuta i zatim ga isključite. Na taj način, bilo

kakvi ostaci proizvodnje ili slojevi će sagorjeti i biti uklonjeni.



Vruće površine izazivaju opekotine!

Uređaj može biti vruć kada se koristi. Nikad nemojte dirati vruće gorionike, unutrašnje dijelove pećnice, grijalice itd. Držite djecu dalje od uređaja.

Uvijek koristite rukavice za pećnicu otporne na vrućinu kada stavljate ili uklanjate posuđe u/iz vrele pećnice.

Električna pećnica

1. Izvadite sve pladnjeve za pečenje i rešetku roštilja van iz pećnice.
2. Zatvorite vrata pećnice.
3. Odaberite položaj Static.
4. Odaberite najveću jačinu roštilja; pogledajte *Kako rukovati električnom pećnicom, Stranica 26*.
5. Pustite pećnicu da radi oko 30 minuta.
6. Isključite vašu pećnicu; Pogledajte *Kako rukovati električnom pećnicom, Stranica 26*

Pećnica sa roštiljom

1. Izvadite sve pladnjeve za pečenje i rešetku roštilja van iz pećnice.
2. Zatvorite vrata pećnice.
3. Odaberite najveću jačinu roštilja; pogledajte *Kako rukovati roštiljom, Stranica 35*.
4. Pustite pećnicu da radi oko 15 minuta.
5. Isključite vašu pećnicu; Pogledajte *Kako rukovati roštiljom, Stranica 35*



Dim i miris mogu se javiti tokom nekoliko sati prilikom inicijalnog puštanja u rad. To je sasvim normalno. Osigurajte da je prostorija dobro ventilirana da bi se uklonio dim i miris. Izbjegavajte direktno inhaliranje dima i mirisa koji se ispušta.

5 Kako koristiti ploču za kuhanje

Opšte informacije o kuhanju



Nikada nemojte puniti tavu uljem više od jedne trećine. Ne ostavljajte ploču za kuhanje bez nadzora kada se zagrijava ulje. Pregrijano ulje predstavlja rizik od požara. **Nikada nemojte pokušavati gasiti mogući požar vodom!** Kada je ulje zahvaćeno vatrom, pokrijte ga protivpožarnim ćebetom ili vlažnom krpom. Isključite ploču za kuhanje ako je bezbjedno da se to uradi i pozovite vatrogasnu službu.

- Prije prženja hrane, uvijek ju dobro posušite i nežno stavite u vrelo ulje. Osigurajte da se smrznuta hrana u potpunosti otopi prije prženja.
- Nemojte pokrivati posude koje koristite kada zagrijavate ulje.
- Postavite tave i duboke tave na način da njihove ručke ne budu iznad ringle kako biste spriječili grijanje ručki. Nemojte stavljati na ringle posude koje nisu balansirane i koje se lako naginju.
- Ne stavljajte prazne posude i duboke tave na zone kuhanja koje su uključene. Mogle bi se oštetiti.
- Ako uključite zone kuhanja da rade bez posude ili duboke tave na njima to može prouzrokovati oštećenja na proizvodu. Isključite zone kuhanja nakon završetka kuhanja.
- Obzirom da površine na proizvodu mogu biti vruće, ne stavljajte plastične i aluminijske posude na njih. Odmah očistite svaku otopinu od tih materijala sa površine. Takve posude se ne bi trebale koristiti niti za čuvanje hrane.

- Koristite tave ili drugo posuđe samo sa ravnim dnom.
- Stavite odgovarajuću količinu hrane u duboke tave ili drugo posuđe. Stoga nećete trebati činiti bilo kakva nepotrebna čišćenja jer ćete time spriječiti da jela kipe van. Ne stavljajte poklopce tava ili drugog posuđa na zone kuhanja. Stavite tave tako da su one centrirane na zoni kuhanja. Kada želite premjestiti posudu na drugu zonu kuhanja, podignite je i postavite na zonu kuhanja koju odaberete, nemojte je vući po površini.

Savjeti za staklokeramičke ploče za kuhanje

- Staklokeramička površina je otporna na toplotu i velike temperaturne razlike ne utiču na nju.
- Nemojte koristiti staklokeramičku površinu kao mjesto za skladištenje ili kao ploču za rezanje.
- Koristite samo tave i drugo posuđe sa mašinski obrađenim dnom. Oštre ivice izazivaju ogrebotine na površini.
- Nemojte koristiti aluminijske posude i tave. Aluminij oštećuje staklokeramičku površinu.

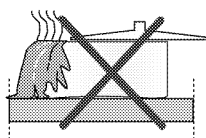

Prosipanje može oštetiti staklokeramičku površinu i prouzrokovati požar.

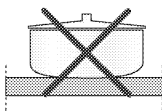

Nemojte koristiti posude sa izbočenim ili udubljenim dnom.

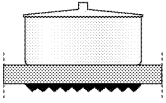

Koristite samo tave i drugo posuđe sa ravnim dnom. One osiguravaju lakši prenos toplote. Ako je prečnik duboke tave premal, energija će se rasipati.

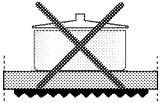

Upotreba ploče za kuhanje

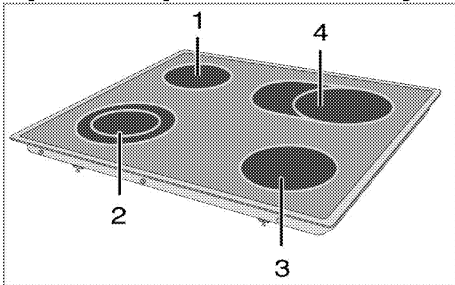

- 1 Ploča za kuhanje sa jednim kolom 14-16cm
- 2 Ploča za kuhanje sa dva kola 21-23/12-14cm
- 3 Ploča za kuhanje sa jednim kolom 18-20cm
- 4 Proširena ploča za kuhanje 17-19/26-28cm je popis predloženih prečnika posuda koje treba koristiti na odgovarajućim gorionicima.



Ne dozvolite da bilo kakvi predmeti padnu na ploču za kuhanje. Čak i mali predmeti kao što je solnica mogu oštetiti ploču za kuhanje. Nemojte koristiti napuknutu ploču za kuhanje. Voda može prolaziti kroz te pukotine i prouzrokovati kratak spoj. U slučaju bilo kakve vrste oštećenja na površini (npr. vidljive pukotine), odmah isključite uređaj da biste minimizirali rizik od elektro šoka.

Staklokeramička ploča za kuhanje je opremljena sa radnim svjetlom i indikatorom upozorenja za vruću zonu. Indikator upozorenja za vruću zonu naznačava status aktivne zone i ostaje svijetliti nakon što se ploča isključi. Svjetlucanje indikatora upozorenja vruće zone nije greška.



Ovisno o upotrebi, površina ploče za kuhanje može se ohladiti u različitim vremenskim intervalima. Površina ploče za kuhanje može biti vruća čak i ako lampice indikatora ne svijetle. Vodite računa da se površina ohladi prije nego je dodirnete. U suprotnom, mogla bi vam izazvati opekotine!



Brzogrjuće staklokeramičke ploče za kuhanje emitiraju jako svjetlo kada su uključene. Nemojte zuriti u jarko svjetlo.

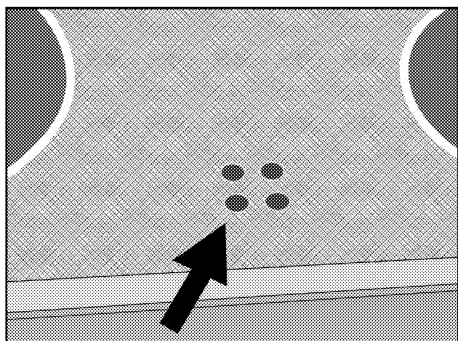

Uključivanje keramičkih ploča

Kontrolne sklopke na ploči za kuhanje koriste se za uključivanje/isključivanje ringli. Za postizanje željene snage kuhanja, okrenite odgovarajuće sklopke na ploči za kuhanje u odgovarajući položaj.

Jačina kuhanja	1	2 – 3	4 – 6
	zagrijavanje	pirjanje, krčkanje	kuhanje, prženje, vrenje

Jačina kuhanja	1	2	3
	zagrijavanje	pirjanje, krčkanje	kuhanje, prženje, vrenje

Isključivanje keramičkih ploča

Okrenite tipku ploče na OFF (gornji) položaj.

Upotreba više-segmentiranih zona kuhanja

Više-segmentirane zone kuhanja omogućavaju kuhanje s različitim veličinama dubokih tava na istoj zoni kuhanja. Kada se ove zone kuhanja aktiviraju, prvo se pali unutrašnja zona kuhanja.

1. Da bi se promijenio prečnik aktivne zone kuhanja, treba okrenuti upravljačku tipku u smjeru kazaljke na satu.
2. Čuti će se zvuk "klik" čim se radijus ringle promijeni.

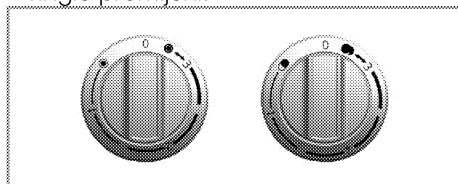

Isključivanje više-segmentnih zona kuhanja

1. Okrenite tipku brojača u smjeru kazaljke na satu u položaj OFF (isključeno) (prema gore) da isključite pećnicu. Svi segmenti zone kuhanja su isključeni.

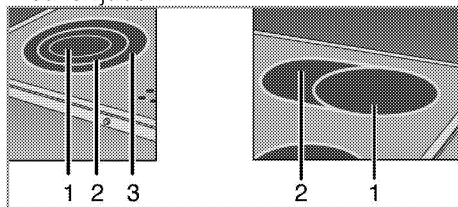

- 1 Položaj 1
- 2 Položaj 2
- 3 Položaj 3

i Položaj 2 i 3 više-segmentiranih zona kuhanja ne rade samostalno.

6 Kako rukovati pećnicom

Opće informacije o pečenju, prženju i roštiljanju



Vruće površine izazivaju opekotine!

Uređaj može biti vruć kada se koristi. Nikad nemojte dirati vruće gorionike, unutrašnje dijelove pećnice, grijalice itd. Držite djecu dalje od uređaja.

Uvijek koristite rukavice za pećnicu otporne na vrućinu kada stavljate ili uklanjate posuđe u/iz vrele pećnice.



Vodite računa kada otvarate vrata pećnice jer iz njene unutrašnjosti može izlaziti para.

Izlazeća para može prouzrokovati opekotine na vašim rukama, licu i/ili očima.

Savjeti za pečenje

- Koristite odgovarajuće obložene neljepljive metalne ploče i aluminijske posude ili silikonske kalupe otporne na toplotu.
- Maksimalno koristite prostor na polici.
- Postavite kalup za pečenje na srednju policu.
- Odaberite ispravan položaj police prije nego uključite pećnicu ili roštilj. Ne mijenjajte položaj police kada je pećnica vruća.
- Držite vrata pećnice zatvorenim.

Savjeti za prženje

- Tretiranje cijelog pileta, ćurke i velikih komada mesa sa začinima poput limunovog soka i crnog bibera prije kuhanja povećati će performanse kuhanja.

- Pečenje mesa s kostima traje oko 15 do 30 minuta duže u poređenju sa prženjem mesa bez kosti iste veličine.
- Svaki centimetar debljine mesa zahtijeva vrijeme kuhanja otprilike 4 do 5 minuta.
- Pustite da meso odstoji u pećnici oko 10 minuta nakon završetka kuhanja. Sok se bolje raspoređuje po cijelom komadu pečenja i ne curi kada se meso siječe.
- Ribu treba staviti na srednju ili donju policu u pladnju otpornom na toplotu.

Savjeti za roštiljanje

Kada se meso, riba i perad pripremaju na roštilju, brzo poprime smeđu boju, imaju finu koricu i ne isušuju se. Ravni komadi, mesni ražnjici i kobasice posebno su podesni za roštilj, kao i povrće sa velikom količinom tečnosti kao što su paradajz i crveni luk.

- Rasporedite komadiće koji će se roštiljati na rešetci ili na plehu za pečenje sa rešetkom na takav način da pokriveni prostor ne prelazi veličinu grijača.
- Gurnite žičanu policu ili pladanj za pečenje sa rešetkom na željeni nivo u pećnicu. Ako roštiljate na žičanoj polici, gurnite pladanj za pečenje na donju policu kako bi se pokupila masnoća. Pladanj za pečenje koji trebate gurnuti mora biti odgovarajuće veličine tako da obuhvata cijelo područje za roštiljanje. Ovaj pladanj možda neće biti isporučen uz proizvod. Dodajte malo vode u pladanj za pečenje radi lakšeg čišćenja.



Hrana koja nije pogodna za roštiljanje nosi sa sobom rizik od požara. Roštiljajte samo hranu koja je podesna za veliku toplotu prženja. Nemojte stavljati hranu suviše daleko u pozadinu roštilja. To je najtopliji dio pećnice i zamašćena hrana se može zapaliti.

Kako rukovati električnom pećnicom

Odaberite temperaturu i način rada

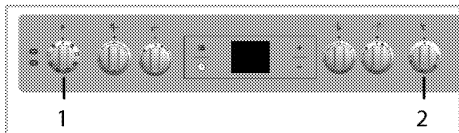

1 Funkcijska sklopka

2 Termostatska sklopka

1. Podesite funkcijsku sklopku na željeni režim rada.

2. Podesite tipku temperature na željenu temperaturu.

» Pećnica se zagrijava do podešene temperature i održava je. Tokom zagrijavanja, lampica temperature ostaje uključena.

Isključivanje električne pećnice

Okrenite funkcijsku sklopku i tipku za temperaturu u položaj isključeno (prema gore).

Važno je pravilno postaviti žičanu rešetku na žičani nosač. Žičana rešetka mora biti umetnuta između nosača kao što je prikazano na slici.

Nemojte dopustiti da žičana rešetka stoji naslonjena na stražnji zid pećnice.

Kliznite vašu rešetku na prednji odjeljak nosača i namjestite je uz pomoć vrata kako biste postigli dobre performanse roštiljanja.

(Varira u ovisnosti od modela proizvoda.)

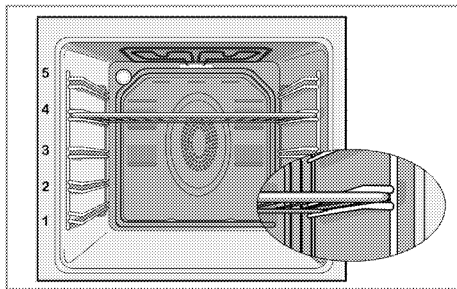

Načini rada

Redoslijed režima rada prikazan ovdje može odstupati od redoslijeda na vašem proizvodu.

Gornje i donje zagrijavanje



Gornje i donje zagrijavanje su u funkciji. Hrana je zagrijana istovremeno s donje i gornje strane. Na primjer, to je pogodno za kolače, tjestenine, ili kolače i kaserole u kalupima za pečenje. Kuhanje samo sa jednim plehom.

Zagrijavanje dna



Samo zagrijavanje donje strane je u funkciji. To je pogodno za pizze i za kasnije rumenjenje hrane s donje strane.



Ova funkcija mora biti korištena za lako čišćenje parom takođe.

Zagrijavanje donje/gornje strane potpomognuto ventilatorom



Gornji i donji grijači plus ventilator (u stražnjem zidu) su u funkciji. Vrući zrak je ravnomjerno distribuiran u cijeloj pećnici brzo pomoću ventilatora. Kuhanje samo sa jednim plehom.

"3D" funkcija



Gornji i donji grijači i zagrijavanje potpomognuto ventilatorom (u stražnjem zidu) su u funkciji. Hrana se kuha ravnomjerno i brzo svuda okolo. Kuhanje samo sa jednim plehom.

Rad sa ventilatorom



Pećnica se ne zagrijava. Radi samo ventilator (u stražnjem zidu). Smrznuta zrnasta hrana polako se odmrzava na sobnoj temperaturi, a pripremljena hrana se hladi. Vrijeme potrebno za odmrzavanje cijelog komada mesa duže je od vremena odmrzavanja hrane sa žitaricama.

Plini roštilj



Veliki roštilj na stropu pećnice je u funkciji. Podesno za roštiljanje velikih količina mesa.

- Stavite velike ili srednje velike porcije na odgovarajuću policu ispod grijača roštilja za roštiljanje.
- Okrenite hranu nakon što protekne polovina vremena roštiljanja.

Zagrijavanje ventilatorom



Zagrijavanje potpomognuto ventilatorom (u stražnjem zidu) je u funkciji.



Vrući zrak je ravnomjerno distribuiran u cijeloj pećnici brzo pomoću ventilatora. Prethodno zagrijavanje u većini slučajeva nije potrebno. Pogodno za kuhanje vaše hrane na različitim nivoima nosača. Podesno za pripremanje hrane na više plehova. Ova funkcija mora biti korištena za lako čišćenje parom takođe.

Roštilj+ventilator



Efekat roštilja nije jak kao kod punog roštilja

- Stavite male ili srednje velike porcije na odgovarajuću policu ispod grijača roštilja za prženje.
- Okrenite hranu nakon što protekne polovina vremena roštiljanja.

Upotreba sata pećnice

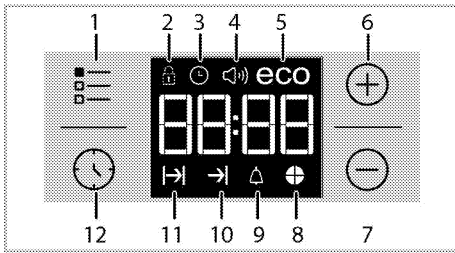

- 1 Tipka za podešavanje
 - 2 Simbol zaključane tipke
 - 3 Simbol sata
 - 4 Simbol jačine alarma *
 - 5 Simbol za Eco režim rada
 - 6 Tipka plus
 - 7 Tipka minus
 - 8 Simbol za vrijeme
 - 9 Simbol za alarm
 - 10 Simbol vremena završetka kuhanja*
 - 11 Simbol vremena kuhanja
 - 12 Taster za program
- * (Varira u ovisnosti od modela proizvoda.)

i Maksimalno vrijeme koje može biti podešeno za kraj kuhanja je 5 sata i 59 minuta. Program će biti poništen u slučaju prekida u napajanju. Morate ponovo programirati pećnicu.

i Dok vršite bilo kakva podešavanja, odgovarajući simboli će treptati na displeju. Morate sačekati neko vrijeme da bi postavke postale aktivne.

i Ako nema nikakvih postavki kuhanja, vrijeme u toku dana se ne može podesiti.

i Ako se vrijeme kuhanja postavi kad počnete kuhati, prikazaće se preostalo vrijeme.

Kuhanje pomoću podešavanja vremena kuhanja;

Rernu možete podesiti da prestane s radom na kraju određenog vremena tako što ćete vrijeme kuhanja podesiti na tajmeru.

1. Odaberite funkciju za kuhanje.
2. Dodirnite dok se simbol ne pojavi na displeju označavajući vrijeme kuhanja.

3. Podesite vrijeme kuhanja tipkama **+** / **-**.

» » Nakon što podesite vrijeme kuhanja, simbol i vrijeme rada će se trajno pojaviti na displeju.

4. Stavite jelo u pećnicu i podesite temperaturu pomoću tipke za temperaturu. Kuhanje će početi.

» Vrijeme kuhanja na displeju počinje teći kad kuhanje počne i svijetle svi dijelovi simbola vremena rada.

Podešeno vrijeme kuhanja je podijeljeno u 4 jednaka dijela i kad vrijeme svakog dijela isteče, simbol tog dijela se gasi. Tako da je lako shvatiti odnos preostalog vremena kuhanja i ukupnog vremena kuhanja.

Podešavanje kraja vremena kuhanja na kasnije vrijeme; (Ova funkcija je opcionalna. Ona se možda neće nalaziti na vašem proizvodu.)

Nakon podešavanja vremena kuhanja na tajmeru, kraj vremena kuhanja možete podesiti na kasnije vrijeme.

1. Odaberite funkciju za kuhanje.
2. Dodirnite dok se simbol ne pojavi na displeju označavajući vrijeme kuhanja.

3. Podesite vrijeme kuhanja tipkama **+** / **-**.

» Nakon što podesite vrijeme kuhanja, simbol **→|** će se trajno pojaviti na displeju.

4. Dodirnite **⏸** dok se simbol **→|** ne pojavi na displeju označavajući kraj vremena kuhanja.

5. Pritisnite tipke **+** / **-** da podesite kraj vremena kuhanja.

» Nakon što podesite vrijeme kuhanja, simbol **→|** plus simbol **→|** i vrijeme rada će se trajno pojaviti na displeju. Kad kuhanje počne, simbol **→|** nestaje.

6. Stavite jelo u pećnicu i podesite temperaturu pomoću tipke za temperaturu. Kuhanje će početi.

» **Programator pećnice računa vrijeme početka oduzimajući vrijeme kuhanja od kraja vremena kuhanja koje ste podesili.** Izabrani način rada se aktivira

kad dođe vrijeme za početak kuhanja i pećnica je zagrijana na podešenu temperaturu. Ova temperatura se održava do kraja vremena kuhanja.

» Vrijeme kuhanja na displeju počinje teći kad kuhanje počne i svijetle svi dijelovi simbola vremena rada.

Podešeno vrijeme kuhanja je podijeljeno u 4 jednaka dijela i kad vrijeme svakog dijela isteče, simbol tog dijela se gasi.

Tako da je lako shvatiti odnos preostalog vremena kuhanja i ukupnog vremena kuhanja.

7. Kad se završi proces kuhanja, na displeju se pojavljuje **"End"** i tajmer šalje zvučno upozorenje.

8. Zvučno upozorenje traje 2 minute. Da prekinete zvučno upozorenje, samo pritisnite bilo koju tipku. Zvučno upozorenje će se utišati i prikazaće se trenutno vrijeme.

i Ako pritisnete bilo koju tipku na kraju zvučnog upozorenja, rerna će ponovo početi s radom. Okrenite dugme za temperaturu i dugme funkcije na položaj **"0"** (isključeno) da isključite rernu da ne bi ponovo počela raditi kad se utiša upozorenje.

Aktiviranje zaključavanja tipki

Aktiviranjem funkcije zaključavanja tipki možete spriječiti mijenjanje zadanih parametara na rerni.

1. Dodirnite **⏸** dok se simbol **⏸** ne pojavi na displeju.

» Na displeju će se pojaviti **"OFF"**.

2. Pritisnite **+** da biste aktivirali zaključavanje tipki.

» Kada je zaključavanje tipki aktivirano, **"On"** se pojavljuje na displeju, a simbol **⏸** ostaje upaljen.

i Tipke pećnice nisu u funkciji kada je aktivirano zaključavanje tipki. Zaključavanje tipki se ne otkazuje u slučaju prekida u napajanju.

Da biste deaktivirali zaključavanje tipki

1. Dodirnite **⏸** dok se simbol **⏸** ne pojavi na displeju.

» Na displeju će se pojaviti **"On"**.

2. Isključite zaključavanje tipki pritiskom na tipku **-**.

» **"OFF"** će se pojaviti kada je deaktivirano zaključavanje tipki.



Podešavanje sata s alarmom

Osim za programiranje kuhanja, tajmer možete koristiti za bilo koje upozorenje ili podsjetnik.

Sat s alarmom ne utiče na funkcije rerne.

On se koristi samo kao upozorenje. Na primjer, ovo je korisno kad u određeno vrijeme želite okrenuti hranu u rerni.

Tajmer će vam poslati zvučno upozorenje na kraju podešenog vremena.

1. Dodirnite  dok se simbol  ne pojavi na displeju.

 Maksimalno vrijeme alarma može biti 23 sata i 59 minuta.

2. Podesite vrijeme trajanja alarma tako što ćete koristiti tipke **+/-**.

 Funkcijske tipke za ton alarma, vrijeme u toku dana, svjetlina ekrana i tipke za temperaturu bi trebale biti u položaju 0 (ISKLJ.).

» Kad je vrijeme alarma podešeno, simbol  će ostati upaljen i vrijeme alarma će se pojaviti na displeju.



3. Kad istekne vrijeme alarma, simbol  počinje treperiti i oglašava se zvučno upozorenje.

Isključivanje alarma

1. Zvučno upozorenje traje 2 minute. Da prekinete zvučno upozorenje, samo pritisnite bilo koju tipku.

» Zvučno upozorenje će se utišati i prikazaće se trenutno vrijeme.



Otkazivanje alarma;

1. Da isključite alarm, dodirnite  dok se simbol  ne pojavi na displeju.

2. Pritisnite i držite tipku **■** dok se ne prikaže "00:00".

 Prikazaće se vrijeme alarma. Ako su vrijeme alarma i vrijeme kuhanja podešeni istovremeno, prikazaće se kraće vrijeme.

Promjena tona alarma

1. Dodirnite  dok se simbol  ne pojavi na displeju.



2. Podesite željeni ton alarma s tipkama **+/-**.

3. Podešeni ton će se aktivirati za kratko vrijeme.

» Izabrani ton alarma biće prikazan kao "b-01", "b-02" ili "b-03" na displeju.

Mijenjanje vremena tokom dana

Da promijenite vrijeme tokom dana koje ste ranije podesili:

1. Dodirnite  dok se simbol  ne pojavi na displeju.

2. Podesite vrijeme tokom dana s tipkama **+/-**.

3. Vrijeme koje ste podesili će se aktivirati za kratko vrijeme.

Ekonomični režim rada

Ekonomičnim režimom rada možete uštediti energiju dok kuhate tako što ćete podesiti vrijeme kuhanja u remi. Isključivanjem grijača prije kraja vremena kuhanja, ovaj režim završava kuhanje s unutrašnjom temperaturom rene.

Podešavanje ekonomičnog režima rada

1. Dodirnite simbol  dok se simbol **eco** ne pojavi na displeju.

» Na displeju će se pojaviti "OFF".

2. Uključite ekonomični režim rada dodiranjem tipke **+**.

» Kada je zaključavanje tipki aktivirano, "On" se pojavljuje na displeju, a simbol eco ostaje upaljen.

Isključivanje ekonomičnog režima rada

1. Dodirnite simbol  dok se simbol **eco** ne pojavi na displeju.

» Na displeju će se pojaviti "On".

2. Isključite ekonomični režim rada dodiranjem tipke **■**.

» "Off" će se pojaviti kad je deaktivirano zaključavanje tipki.

Podešavanje osvjetljenja ekrana

(Ova funkcija je opcionalna. Ona se možda neće nalaziti na vašem proizvodu.)

1. Dodirnite  dok se **d-01** ili **d-02** ili **d-03** ne pojavi na displeju označavajući osvjetljenje displeja.

2. Podesite željeno osvjetljenje s tipkama **+/-**.

» Vrijeme koje ste podesili će se aktivirati za kratko vrijeme.

Tabela vremena kuhanja

i Vremena u ovoj karti služe kao vodič. Vremena mogu varirati zbog temperature hrane, debljine, vrste i vaših vlastitih preferencija u vezi kuhanja.

Pečenje i prženje

i 1. policica pećnice je donjapolica.

Posuda	Broj pladnjeva	Dodatna oprema za korištenje	Način rada	Položaj police	Temperatura (°C)	Vrijeme kuhanja (približno u min.)
Kolači u plehu	Jedan pladanj	Standardni pladanj*		3	180	25 ... 30
Kolači u kalupu	Jedan pladanj	Kalup za tortu na rešetci roštilja**		2	180	40 ... 50
Mali kolači	Jedan pladanj	Standardni pladanj*		3	160	25 ... 35
	Jedan pladanj	Standardni pladanj*		3	150	30 ... 40
	2 pladnja	1-Pladanj za tijesto* 3-Standardni pladanj*		1 - 3	150	35 ... 50
	3 pladnja	1-Standardni pladanj* 3-Pladanj za tijesto* 5-Duboki pladanj*		1 - 3 - 5	150	35 ... 50
Biskvit kolač	Jedan pladanj	Okrugla opružna tava prečnika 26 cm na rešetci roštilja**		3	160	25 ... 35
	Jedan pladanj	Okrugla opružna tava prečnika 26 cm na rešetci roštilja**		2	150	30 ... 40
	2 pladnja	1-Okrugla opružna tava prečnika 26 cm na rešetci roštilja** 4-Okrugla opružna tava prečnika 26 cm na pladnju za tijesto**		1 - 4	150	35 ... 45
Kolači	Jedan pladanj	Pladanj za tijesto*		3	180	25 ... 30
	2 pladnja	1-Pladanj za tijesto* 3-Standardni pladanj*		1 - 3	180	30 ... 40
	3 pladnja	1-Pladanj za tijesto* 3-Standardni pladanj* 5-Duboki pladanj*		1 - 3 - 5	180	35 ... 45
Kolači od tijesta	Jedan pladanj	Standardni pladanj*		2	200	30 ... 40
	2 pladnja	1-Pladanj za tijesto* 5-Standardni pladanj*		1 - 5	200	45 ... 55

Posuda	Broj pladnjeva	Dodatna oprema za korištenje	Način rada	Položaj police	Temperatura (°C)	Vrijeme kuhanja (približno u min.)
	3 pladnja	1-Pladanj za tijesto* 3-Standardni pladanj* 5-Duboki pladanj*		1 - 3 - 5	200	55 ... 65
Filovana tjestenina	Jedan pladanj	Standardni pladanj*		2	200	25 ... 35
	2 pladnja	1-Pladanj za tijesto* 3-Standardni pladanj*		1 - 3	200	35 ... 45
	3 pladnja	1-Pladanj za tijesto* 3-Standardni pladanj* 5-Duboki pladanj*		1 - 3 - 5	190	45 ... 55
Kvasac	Jedan pladanj	Standardni pladanj*		2	200	35 ... 45
Lazanje	Jedan pladanj	Staklena/metalna pravougaona tava na rešetci roštilja**		2 - 3	200	30 ... 40
Pizza	Jedan pladanj	Standardni pladanj*		2	200 ... 220	15 ... 20
Govedi odrezak (cijel) / pržen	Jedan pladanj	Standardni pladanj*		3	25 min. 250/max, zatim 180 ... 190	100 ... 120
Janjeći but (lonac)	Jedan pladanj	Standardni pladanj*		3	25 min. 250/max, zatim 190	70 ... 90
	Jedan pladanj	Standardni pladanj*		3	25 min. 250/max, zatim 190	60 ... 80
Pileće pečenje (1,8-2 kg)	Jedan pladanj	Standardni pladanj*		2	15 min. 250/max, zatim 180 ... 190	60 ... 80
	Jedan pladanj	Standardni pladanj*		2	15 min. 250/max, zatim 180 ... 190	60 ... 80
Ćurka (5.5 kg)	Jedan pladanj	Standardni pladanj*		1	25 min. 250/max, zatim 180 ... 190	150 ... 210
	Jedan pladanj	Standardni pladanj*		1	25 min. 250/max, zatim 180 ... 190	150 ... 210
Riba	Jedan pladanj	Standardni pladanj*		3	200	20 ... 30
	Jedan pladanj	Standardni pladanj*		3	200	20 ... 30

Preporučuje se prethodno zagrijavanje za sve vrste hrane.











* Moguće je da ovaj dodatni pribor ne bude isporučen s proizvodom.



** Ovaj dodatni pribor nije isporučen s proizvodom. Ovaj dodatni pribor je komercijalno dostupan.

Tabela kuhanja za testiranje jela

Jela u ovoj tabeli kuhanja su pripremljena u skladu sa EN 60350-1

kako bi se omogućilo kontrolnim institucijama da testiraju proizvode.

Posuda	Broj pladnjeva	Dodatna oprema za korištenje	Način rada	Položaj police	Temperatura (°C)	Vrijeme kuhanja (približno u min.)
Shortbread	Jedan pladanj	Standardni pladanj*		3	140	20 ... 30
	Jedan pladanj	Standardni pladanj*		3	140	20 ... 30
	2 pladnja	1-Standardni pladanj* 3-Pladanj za tijesto*		1 - 3	140	20 ... 30
	3 pladnja	1-Standardni pladanj* 3-Pladanj za tijesto* 5-Duboki pladanj*		1 - 3 - 5	140	25 ... 35
Mali kolači	Jedan pladanj	Standardni pladanj*		3	160	25 ... 35
	Jedan pladanj	Standardni pladanj*		3	150	30 ... 40
	2 pladnja	1-Pladanj za tijesto* 3-Standardni pladanj*		1 - 3	150	35 ... 50
	3 pladnja	1-Standardni pladanj* 3-Pladanj za tijesto* 5-Duboki pladanj*		1 - 3 - 5	150	35 ... 50
Biskvit kolač	Jedan pladanj	Okrugla opružna tava prečnika 26 cm na rešetci roštilja**		3	160	25 ... 35
	Jedan pladanj	Okrugla opružna tava prečnika 26 cm na rešetci roštilja**		2	150	30 ... 40
	2 pladnja	1-Okrugla opružna tava prečnika 26 cm na rešetci roštilja** 4-Okrugla opružna tava prečnika 26 cm na pladnju za tijesto**		1 - 4	150	35 ... 45

Posuda	Broj pladnjeva	Dodatna oprema za korištenje	Način rada	Položaj police	Temperatura (°C)	Vrijeme kuhanja (približno u min.)
Pita s jabukama	Jedan pladanj	Okrugla crna metalna posuda prečnika 20 cm na rešetci roštilja**		2	180	50 ... 60
	Jedan pladanj	Okrugla crna metalna posuda prečnika 20 cm na rešetci roštilja**		2	170	50 ... 60
	2 pladnja	1-Okrugla crna metalna posuda prečnika 20 cm na rešetci roštilja** 4-Okrugla crna metalna posuda prečnika 20 cm na pladnju za tijesto**		1 - 4	170	50 ... 60

Preporučuje se prethodno zagrijavanje za sve vrste hrane.
* Moguće je da ovaj dodatni pribor ne bude isporučen s proizvodom.
** Ovaj dodatni pribor nije isporučen s proizvodom. Ovaj dodatni pribor je komercijalno dostupan.

Upute za pečenje kolača

- Ako je kolač previše suh, povećajte temperaturu za nekih 10°C i smanjite vrijeme kuhanja.
- Ako je kolač vlažan, koristite manje tečnosti ili snizite temperaturu za 10°C.
- Ako je kolač previše taman na vrhu, postavite ga na nižu полицu, snizite temperaturu i povećajte vrijeme kuhanja.
- Ako je skuhanu dobro s unutrašnje strane ali je gnjecavo s vanjske strane koristite manje tečnosti, snizite temperaturu i povećajte vrijeme kuhanja.

Upute za pečenje tijesta

- Ako je kolač previše suh, povećajte temperaturu za nekih 10°C i smanjite vrijeme kuhanja. Navlažite slojeve tijesta sosom od mlijeka, ulja, jaja i jogurta.

- Ako traje predugo da se kolač ispeče, pobrinite se da debljina tijesta koje ste pripremili ne premašuje dubinu pleha.
- Ako je gornja strana kolača postala braonkasta, ali donja strana još nije kuhana, uvjerite se da količina sosa koji se upotrijebili za kolač nije prevelika na dnu kolača. Pokušajte ravnomjerno rasporediti sos između i po slojevima tijesta kako bi ravnomjerno porumenili.

i Pecite tijesto u skladu sa režimom rada i temperaturom koji su dati u tabeli kuhanja. Ako donji dio još nije dovoljno rumen, slijedeći put ga stavite na jednu полицu niže.

Uputstva za kuhanje povrća

- Ako jelo od povrća ostaje bez sokova i postaje previše suho, kuhajte ga u tavi sa poklopcem umjesto u plehu. Zatvorene posude će sačuvati sokove koje daje jelo.

- Ako se jelo od povrća ne skuha, prokuhajte povrće unaprijed ili ga pripremite kao konzerviranu hranu i stavite u pećnicu.

Kako rukovati roštiljom



Zatvorite vrata pećnice tokom pečenja na roštilju.
Vruće površine mogu izazvati opekotine!

Uključivanje roštilja

1. Okrenite funkcijski sklopku do željenog simbola roštilja.
 2. Zatim odaberite željenu temperaturu roštilja.
 3. Ako je potrebno, uradite prethodno zagrijavanje oko 5 minuta.
- » Lampica temperature se pali.

Roštiljanje električnim roštiljom

Hrana	Dodatna oprema za korištenje	Položaj police	Preporučena temperatura (°C)**	Vrijeme roštiljanja (približno)
Riba	Rešetka roštilja	4...5	250/max	20...25 min. #
Pileći odrezak	Rešetka roštilja	4...5	250/max	25...35 min.
Sjeckana janjetina	Rešetka roštilja	4...5	250/max	20...25 min.
Govede pečenje	Rešetka roštilja	4...5	250/max	25...30 min. #
Sjeckana teletina	Rešetka roštilja	4...5	250/max	25...30 min. #
Tost *	Rešetka roštilja	4	250/max	1...3 min.

ovisno o debljini
*Prethodno zagrijati tokom 5 minuta
**Ako se temperatura roštilja vašeg proizvoda ne može podesiti, roštilj će raditi na preporučenoj temperaturi.

Jela u ovoj tabeli kuhanja su pripremljena u skladu sa EN 60350-1

kako bi se omogućilo kontrolnim institucijama da testiraju proizvode.

Hrana	Dodatna oprema za korištenje	Položaj police	Temperatura (°C)	Vrijeme kuhanja (približno u min.)
Tost	Rešetka roštilja	4	250/max	1...3 min.
Čufte (govedina) - 12 komadi	Rešetka roštilja	4	250/max	25...35 min.

Okrenite hranu nakon 2/3 ukupnog vremena roštiljanja.
Preporučuje se prethodno zagrijavanje od 5 minuta za prženje svake vrste hrane.

Isključivanje roštilja

1. Okrenite funkcijsku sklopku u položaj Off (isključeno) (prema gore).



Hrana koja nije pogodna za roštiljanje nosi sa sobom rizik od požara. Roštiljajte samo hranu koja je podesna za veliku toplotu prženja. Nemojte stavljati hranu suviše daleko u pozadinu roštilja. To je najtopliji dio pećnice i zamašćena hrana se može zapaliti.

Vrijeme pripremanja hrane korištenjem funkcije roštilja

7 Održavanje i njega

Opšte informacije

Životni vijek proizvoda će biti produžen, a učestali problemi će se smanjiti ukoliko se proizvod čisti u redovnim intervalima.



Isključite uređaj s glavnog napajanja prije započinjanja aktivnosti oko održavanja i čišćenja.

Postoji rizik od elektro šoka!



Sačekajte da se uređaj ohladi prije čišćenja.

Vruće površine mogu izazvati opekotine!

- Očistite temeljito proizvod nakon svake upotrebe. Na taj način će biti moguće lakše uklanjanje ostataka kuhanja, te oni neće gorjeti prilikom narednog korištenja uređaja.
- Za čišćenje uređaja nisu potrebna posebna sredstva za čišćenje. Koristite toplu vodu s tečnošću za pranje, mekanu krpu ili spužvu da očistite proizvod i zatim ga prebrišete suhom krpom.
- Uvijek osigurajte da bilo kakav višak tečnosti bude temeljito obrisan nakon čišćenja i sve što je proljeveno da se odmah posuši brisanjem.
- Nemojte koristiti sredstva za čišćenje koja sadrže kiseline ili hlorid da biste čistili površine od nehrđajućeg materijala ili od inoksa niti za čišćenje ručke. Koristite mekanu krpu sa tečnim deterdžentom (ne abrazivnim) da prebrišete te dijelove, obratite pažnju da brišete u jednom smjeru.



Neki deterdženti i materijali za čišćenje mogu izazvati oštećenja na površini.

Nemojte koristiti agresivne deterdžente, praškove/kreme za čišćenje ili bilo kakve oštre predmete dok čistite.



Nemojte koristiti čistače na paru da čistite uređaj jer bi to moglo prouzrokovati strujni udar.

Čišćenje ploče za kuhanje.

Staklo-keramička površina

Obrišite staklo-keramičku površinu (vitrokeramika) hladnom vodom, obraćajući pažnju da ne ostavljate ostatke sredstva za čišćenje, a potom osušite mekanom krpom. Ostaci mogu prouzrokovati oštećenja na staklo keramičkoj površini kada se ploča koristi prilikom slijedećeg kuhanja. Osušene ostatke na staklo-keramičkoj površini (vitrokeramika) ni pod kakvim okolnostima ne bi trebalo strugati oštrim predmetima, čeličnom vunom ili sličnim alatima.

Odstranite mrlje od kalcija (žute mrlje) pomoću komercijalno dostupnih odstranjivača vapna ili manjom količinom odstranjivača vapna poput octa ili soka od limuna.

Ako je površina jako zaprljana, nanesite sredstvo za čišćenje na spužvu i sačekajte da se dobro upije. Zatim očistite površinu ploče za kuhanje vlažnom krpom.

i Hrana na bazi šećera kao što su jake kreme i sirupi mora se odmah očistiti, bez čekanja da se površina ohladi. U protivnom, staklo-keramička površina se može trajno oštetiti.

Blago blijeđenje boje se može pojaviti na premazima ili drugim površinama tokom vremena. Ovo ne utiče na rad proizvoda. Blijeđenje boje i mrlje na staklo keramičkoj površini je normalna pojava, nije greška.

Čišćenje kontrolne ploče

Očistite kontrolnu ploču i kontrolne tipke vlažnom krpom te ih potom osušite.

i Ako je proizvod opremljen dugmadima/tipkama, nemojte uklanjati kontrolnu dugmad da čistite kontrolnu tablu. Kontrolna tabla bi se mogla oštetiti!

Čišćenje pećnice

Čišćenje bočnih zidova(Varira u ovisnosti od modela proizvoda.)

(Ova funkcija je opcionalna. Ona se možda neće nalaziti na vašem proizvodu.)

1. Uklonite prednji dio bočnog nosača tako što ćete ga povući u smjeru suprotnom od bočnog zida.
2. Uklonite bočni nosač u potpunosti tako što ćete ga povući prema sebi.

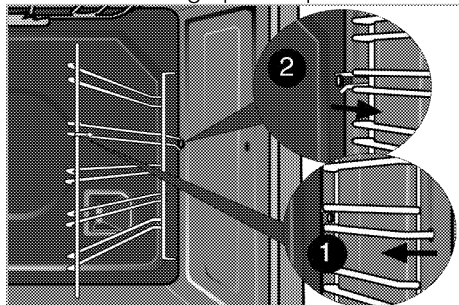

Katalitički zidovi

(Ova funkcija je opcionalna. Ona se možda neće nalaziti na vašem proizvodu.)

Unutrašnji bočni zidovi (A) i/ili stražnji zid (B) vašeg proizvoda mogu biti obloženi katalitičkim emajlom. Katalitički zidovi imaju svijetlu mat boju i poroznu površinu. Katalitički zidovi pećnice se ne trebaju čistiti. Zahvaljujući svojoj perforiranoj strukturi, katalitičke površine apsorbiraju mast i kad se površina ispuni mašću, počinju sjajiti. U ovom slučaju preporučuje se zamjena dijelova.

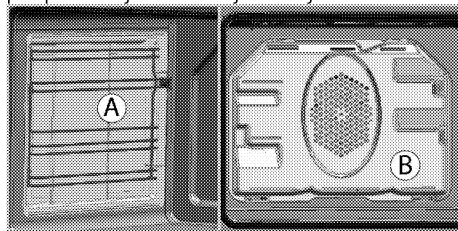

Lako čišćenje parom

To osigurava lako čišćenje jer se prljavština (bez predugog čekanja) omekša pomoću pare koja se formira unutar pećnice i vodenih kapljica koje se kondenzuju na unutrašnjim površinama pećnice.

1. Uklonite sav pribor iz pećnice.
2. Ulijte 500 ml vode u pladanj pećnice i postavite pladanj na 2. policu u pećnici.

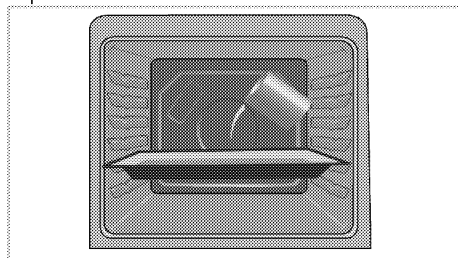

3. Postavite pećnicu na jednostavan način rada čišćenje parom i rade na 100 ° C 25 minuta.

4. Otvorite vrata i obrišite unutrašnje površine u pećnici sa vlažnom spužvom ili krpom.
5. Koristite toplu vodu s tečnošću za pranje, mekanu krpu ili spužvu da očistite postojeća zaprljanja i zatim prebrišite suhom krpom.

i U toku režima laganog čišćenja pomoću pare, voda se postavlja u pladanj tako da se ostaci/prljavština u unutrašnjosti pećnice isparavaju i kondenzuju u šupljinu pećnice i unutrašnje staklo pećnice, tako da voda može da kaplje kada je vrata pećnice otvorena. Obrišite kondenzaciju čim se vrata pećnice otvore.

Čišćenje vrata pećnice

Da biste očistili vrata pećnice, koristite toplu vodu s tečnošću za pranje, mekanu krpu ili spužvu da očistite proizvod i zatim prebrišite suhom krpom. Staklo obrišite octom, a zatim ga isperite kako bi uklonili ostatke kamenca koji se mogu pojaviti na staklu pećnice.

i Nemojte koristiti bilo kakva gruba abrazivna sredstva za čišćenje ili oštre metalne strugače za čišćenje vrata pećnice. Njima se može izgrebati površina i uništiti staklo.

Čišćenje vrata rerne

i Da biste očistili vrata i stakla rerne nemojte koristiti gruba abrazivna sredstva za čišćenje, metalne strugače, žičanu vunu ili sredstva za bijeljenje.

Možete da skinete vrata i staklo rerne da biste ih očistili. Kako ukloniti vrata i staklo objašnjeno je u odjeljcima „Skidanje vrata rerne“ i „Skidanje unutrašnjeg stakla na vratima rerne“.

Nakon što skinete unutrašnje staklo na vratima, očistite ga sredstvom za pranje posuđa, toplom vodom i mekom krpom ili sunderom i osušite suvom krpom. Staklo obrišite octom, a zatim ga isperite kako bi uklonili ostatke kamenca koji se mogu pojaviti na staklu pećnice.

Skidanje vrata pećnice

1. Otvorite prednja vrata (1).
2. Otvorite spojnice na kućištu šarke (2) na desnoj i lijevoj strani prednjih vrata tako što ćete ih pritisnuti prema dolje kako je prikazano na slici.

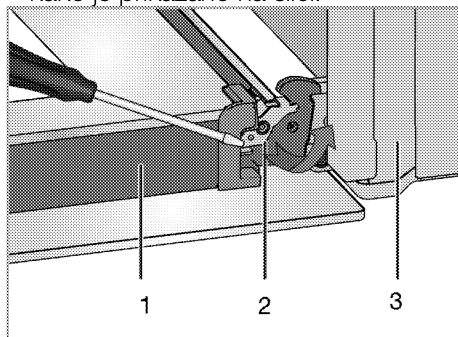

- 1 Vrata
- 2 Zaključavanje šarke(zatvorena pozicija)
- 3 Pećnica
- 4 Zaključavanje šarke(otvorena pozicija)

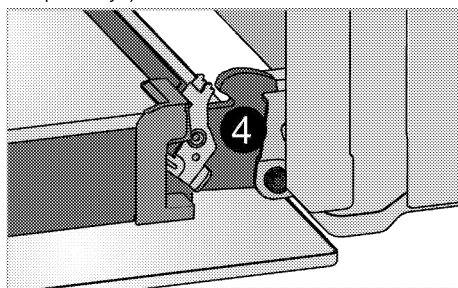

3. Pomjerite prednja vrata do polovine.

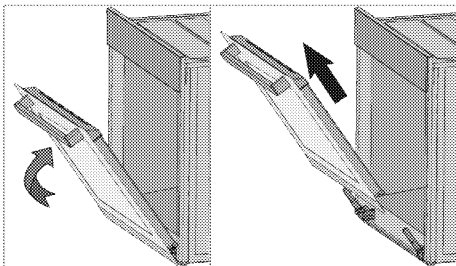

4. Uklonite prednja vrata povlačenjem prema gore kako biste ih oslobodili veze sa šarkama na lijevoj i desnoj strani.

i Koraci koje ste izvodili prilikom procesa skidanja trebali bi biti ponovljeni obrnutim redoslijedom kada sklapate vrata. Nemojte zaboraviti zatvoriti spojnice na kućištu šarki prilikom postavljanja vrata.

Uklanjanje unutrašnjeg stakla na vratima

(Ova funkcija je opcionalna. Ona se možda neće nalaziti na vašem proizvodu.)

Unutrašnja staklena ploča na vratima pećnice može se skinuti radi čišćenja.

1. Otvorite vrata pećnice.

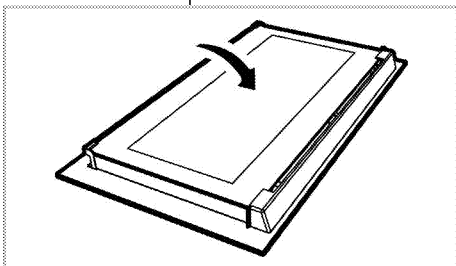

2. Povucite prema sebi i uklonite plastični dio postavljen na gornjem odjeljku prednjih vrata.

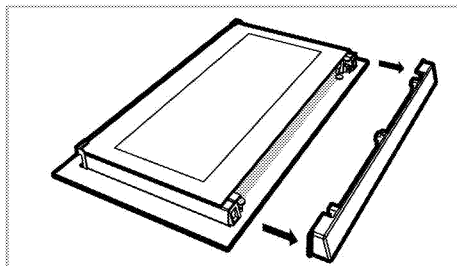

3. Kao što je prikazano na slici, lagano podignite najskrovitiju staklenu ploču (1) u smjeru **A** i povucite je van u smjeru **B**.

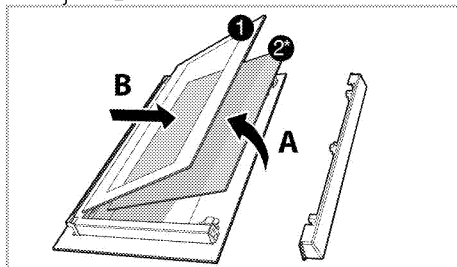

- 1 Najskrovitija (unutrašnja) staklena ploča
- 2* Unutrašnja staklena ploča (Ona se možda neće nalaziti na vašem proizvodu.)
4. Ako je vaš proizvod opremljen unutrašnjom staklenom pločom (2); ponovite istu proceduru za uklanjanje unutrašnje staklene ploče (2).
5. Prvi korak da se ponovo sklope vrata jeste postavljanje unutrašnje staklene ploče (2). postavite zarubljeni ugao staklene ploče tako da ostane u zarubljenom uglu plastičnog proreza. (Ako je vaš proizvod opremljen unutrašnjom staklenom pločom). Unutrašnja staklena ploča (2) mora biti postavljena u plastični prorez u blizini najskrovitije staklene ploče (1).
6. Kada postavljate najskrovitiju staklenu ploču (1), budite sigurni da ispisana strana ploče bude okrenuta prema unutrašnjoj staklenoj ploči. Važno je da se donji ugao najskrovitija (unutrašnja)

staklena ploče (1) smjesti u donji plastični prorez.

7. Gurajte plastični dio prema okviru dok ne čujete zvuk "klik".

Zamjena svjetla u pećnici

! Prije zamjene sijalice u pećnici, budite sigurni da je uređaj isključen iz elektro mreže i ohlađen kako biste izbjegli rizik od elektro šoka.

Vruće površine mogu izazvati opekotine!

i U ovoj pećnici koristi se žarulja sa žarnom niti snage manje od 40 W, visine manje od 60 mm, promjera manje od 30 mm ili halogena lampa sa utičnicom tipa G9, snage manje od 60 W. Svjetiljke su pogodne za rad na temperaturama iznad 300 °C. Lampe za pećnicu možete nabaviti od ovlaštenog servisera ili tehničara sa licencom.

i Pozicija lampice može biti drugačija od one prikazane na slici.

i Lampica koja se koristi u ovom uređaju nije pogodna za osvjtljavanje prostorija u domaćinstvu. Namijenjena upotreba za ovu lampicu je da pomogne korisniku da vidi namirnice.

i Lampice koje se koriste u ovom uređaju moraju podnositi ekstremne fizičke uslove kao što su temperature iznad 50°C.

Ukoliko je vaša pećnica opremljena okruglom lampicom:

1. Iskopčajte proizvod sa napajanja.
2. Okrenite stakleni poklopac u smjeru suprotnom od smjera kretanja kazaljke na satu kako biste ga skinuli.

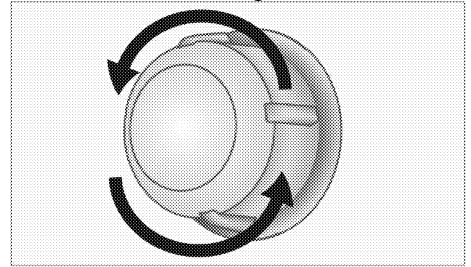

3. Ako je lampica vaše pećnice tipa (A), kako je prikazano na slici u nastavku, izvadite je tako što ćete je rotirati kao što je prikazano i zamijenite je. Ako je lampica tipa (B), povucite je i izvadite kao što je prikazano na slici i zamijenite je.

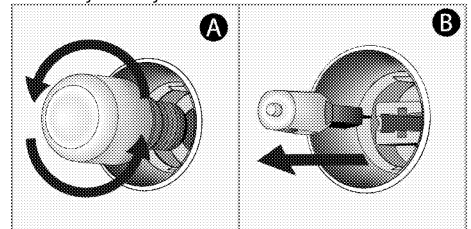

4. Vratite stakleni poklopac na mjesto.

8 Rješavanje problema

Pećnica ispušta paru kada je u upotrebi.

- Uobičajeno je da tokom rada iz uređaja izlazi para. >>> *Nije riječ o kvaru.*

Proizvod odašilje metalne zvukove dok se zagrijava i hladi.

- Kada se metalni dijelovi zagrijavaju, mogu se širiti i praviti zvukove. >>> *Nije riječ o kvaru.*

Proizvod ne radi.

- Osigurač napajanja je pokvaren ili je pregorio. >>> *Provjerite osigurače u kutiji s osiguračima. Ako je potrebno, zamijenite ih ili vratite u početni položaj.*
- Proizvod nije uključen u (uzemljen) utičnicu. >>> *Provjerite utikač na kablu.*

Svjetlo u pećnici ne radi.

- Sijalica u pećnici je pokvarena. >>> *Zamijenite sijalicu u pećnici.*
- Napajanje je prekinuto. >>> *Provjerite da li ima napajanja. Provjerite osigurače u kutiji s osiguračima. Ako je potrebno, zamijenite ih ili vratite u početni položaj.*

Pećnica se ne zagrijava.

- Funkcija i/ili temperatura nisu podešene. >>> *Podesite funkciju i temperaturu pomoću sklopke/tipke za odabir funkcije ili temperature.*
- Kod modea koji su opremljeni programatorom, programator nije podešen. >>> *Podesite vrijeme.*
(Kod proizvoda sa mikrovalnom pećnicom, programator upravlja samo mikrovalnom pećnicom.)
- Napajanje je prekinuto. >>> *Provjerite da li ima napajanja. Provjerite osigurače u kutiji s osiguračima. Ako je potrebno, zamijenite ih ili vratite u početni položaj.*

(Kod modela sa programatorom) ekran sata trepće ili simbol sata

svijetli.

- Ranije se dogodio prekid u napajanju. >>> *Podesite vrijeme / isključite proizvod i zatim ga ponovo uključite.*



Ukoliko ne možete ukloniti problem čak iako ste implementirali uputstva iz ovog odjeljka, posavjetujte se sa ovlaštenim serviserom ili trgovcem kod kojeg ste kupili vaš proizvod. Nikada ne pokušavajte sami popravljati neispravan proizvod.

