

Quick Guide

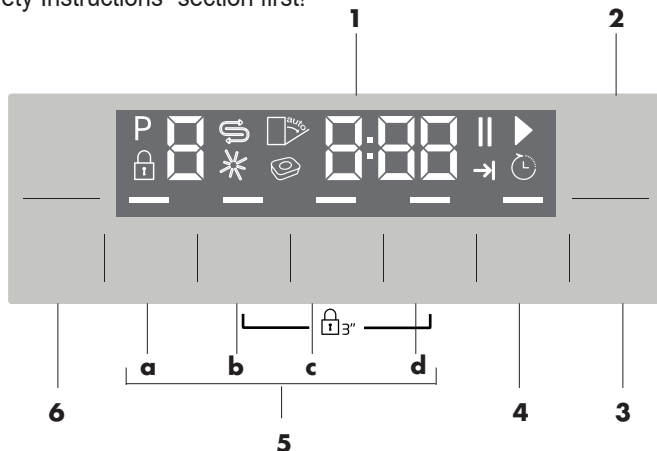

Operating the product

 Read "Safety Instructions" section first!

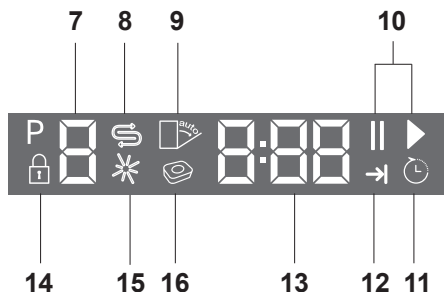

1. Display
2. On/Off key
3. Start/Pause/Cancel key
4. Time Delay key
5. Function keys
 - a) Half Load function
 - b) Fast+ Function
 - c) SteamGloss Function
 - d) AqualIntense Function
6. Programme Selection keys



7. Programme indicator
8. Salt () indicator
9. Not in use
10. Start () / Pause () indicator
11. Time Delay indicator
12. End of Programme indicator
13. Screen information line
14. Child Lock indicator
15. Rinse aid () indicator
16. Not in use

Programme Table

Programme Data and Average Consumption Values Table

Programme number	0	1	2	3	4	5	6	7	8
Programme name	InnerClean	Eco ***	Auto	AquaFlex	Intensive	Quick&Shine	GlassCare	Mini	Prewash
Cleaning temperature	-	50 °C	40-65 °C	-	70 °C	60 °C	40 °C	35 °C	-
Degree of Soiling	This programme is recommended to be operated on every 1-2 months for machine cleaning and necessary hygiene. The programme should be operated while the machine is empty. In order to achieve an efficient result use together with special machine cleaning agents	Suitable for washing dishes with normal amount of soil. It is the most efficient program in terms of combined power and water consumption. This is used for assessing the compliance with EU's eco-design directive.	Determines the soiling degree of the dishes and sets the temperature and amount of the washing water as well as the washing time automatically. Suitable for all types of dishes.	It is the most suitable washing programme for daily mixed dishes including plastic items. White delicate glass items are washed in the upper basket, pans and trays can be washed in the lower basket.	Suitable for heavily soiled dishes, pots and pans.	Daily washing programme for normally soiled dishes in the fastest way.	Special programme for gentle cleaning of delicate glassware.	Suitable for lightly soiled daily dishes that are scraped or pre-cleaned.	Suitable for removing remnants on the soiled dishes that will be kept waiting in the machine for a few days, and thus for preventing the bad odour buildup.
Prewash	-	Medium	Medium to high	Medium	High	Medium	Low	Low	-
Wash	-	+	+	+	+	-	+	-	+
Dry	-	+	+	+	+	+	+	+	-
Duration (min)	75	220	110-178	203	170	58	120	30	15
Water (l)	15,2	9,5	9,4-12,4	19	16,8	10,6	13,6	10,8	4
Energy (kWh)	0,70	0,93* / 0,951**	0,90-1,45	1,53	1,51	1,18	1,20	0,80	-

* : EN 60436:2010 ** : EN 60436:2020 The consumption values shown in the table were determined under standard conditions. Differences may therefore occur under practical conditions. *** Reference programme for testing institutes. The tests in accordance with EN 50242:60436 must be carried out with a full water softener salt dispenser and a full rinse aid reservoir, and using the test programme. The values given for programmes other than Eco 50°C programme are indicative only.







Loading Capacity : 14

Quick Guide

Adjusting the water softening system

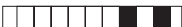
Washing, rinsing and drying performance of your dishwasher will improve when the water softening system is adjusted correctly.







To adjust the system, first learn the water hardness in your region and adjust as indicated below.

- Unpack the test strip.
 - Open the tap and let the water flow for approx. 1 minute.
 - Dip in the test strip into the water for 1 second.
 - Take out the strip from the water and shake it.
 - Wait for 1 minute.
 - Make the necessary adjustment according to the test strip.
- | | |
|---------|------------------------------------------------------------------------------------|
| Level 0 |  |
| Level 1 |  |
| Level 2 |  |
| Level 3 |  |
| Level 4 |  |
| Level 5 |  |

After detecting the water hardness:

1. After turning on the machine, press Delayed Start and P+ keys simultaneously. After the countdown (3, 2, 1) is displayed keep the keys pressed for a while.
2. Press P+ key to activate the \curvearrowright position.
3. Using Delayed Start key, adjust water hardness level according to the hardness of the supply water. See “Water hardness level adjustment table” for correct setting.
4. Press On / Off key to save the setting.

Water hardness level adjustment table

Hardness Level	English Water Hardness °dE	German Water Hardness °dH	French* Water Hardness °dF	Water Hardness Level Indicator
Level 0 	0-5	0-4	0-8	Press the Delayed Start key to switch the water hardness level to position 1. (r1)
Level 1 	6-9	5-7	9-13	
Level 2 	10-15	8-12	14-22	Press the Delayed Start key to switch the water hardness level to position 2. (r2)
Level 3 	16-19	13-15	23-27	Press the Delayed Start key to switch the water hardness level to position 3. (r3)
Level 4 	20-24	16-19	28-34	Press the Delayed Start key to switch the water hardness level to position 4. (r4)
Level 5 	25-62	20-50	35-90	Press the Delayed Start key to switch the water hardness level to position 5. (r5)

Regeneration Adjustment Switch

If your machine equipped with Regeneration Adjustment Switch; perform the same hardness level adjustment that you have set on the control panel also with the regeneration adjustment switch. For example, if you have adjusted to “3” in the control panel, also set the regeneration adjustment switch to 3.

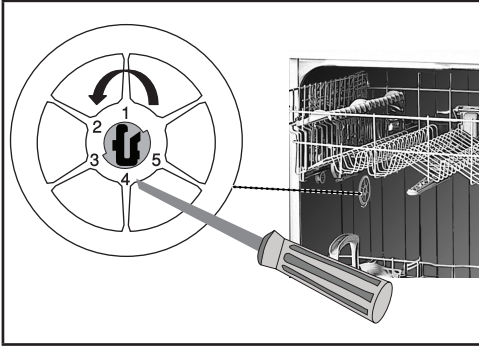

Level 0	Level 1	Level 2	Level 3	Level 4	Level 5
1	1	2	3	4	5

- If the hardness level of the water that you use is above 50°dH or if you are using well water, than it is recommended to use filter and water purification devices.
 - If the hardness level of the water that you use is below 7°dH, there is no need to use salt in your dishwasher. In this case, the Salt Indicator light on the control panel of your dishwasher will light continuously.
 - If the water hardness is set to level 1, the Salt Indicator will light continuously although it is not necessary to use salt. If you use salt under this condition, salt will not be consumed and the lamp will not illuminate.
- i** When moving, you will need to set the water hardness level of your dishwasher again according to the information above, depending on the water hardness of the place you have moved to.
- i** If the water hardness level of your machine is adjusted previously, your machine will display the most recent hardness level adjustment.