

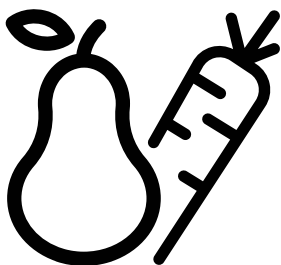

**Refrigerator**  
User manual



CDA 565FS - CDA 564FW - CF 5015APW - CF5015APS  
CFG1501W - CFG1501S



**EN /**

48 6378 0005 /AU

## Please read these instructions first before using your appliance

Thank you for choosing a Beko appliance.

Please take some time to read this user manual before using your appliance, to ensure you know how to safely operate the controls and functions.

Carefully follow all unpacking and installation instructions to ensure the appliance is correctly connected and fitted prior to use.



Please write your product model and serial number on the last page of this user manual, and store in a safe location close to the appliance for easy future reference.





This user manual may also be applicable for several other models. Differences between models will be listed.

If you have any questions or concerns, please call our contact centre or find help and information online at [www.beko.co.uk](http://www.beko.co.uk)

### Symbols and their descriptions

This instruction manual contains the following symbols:

-  Important information or useful usage tips.
-  Warning against dangerous conditions for life and property.
-  Warning against electric voltage.

 <b>INFORMATION</b>  SUPPLIER'S NAME:  MODEL IDENTIFIER:  (*)	The model information as stored in the product data base can be reached by entering following website and searching for your model identifier (*) found on energy label. <a href="https://eprel.ec.europa.eu/">https://eprel.ec.europa.eu/</a>
--	---

---

<b>1 Your refrigerator</b>	<b>4</b>	<b>5 Using your refrigerator</b>	<b>16</b>
<b>2 Warnings</b>	<b>5</b>	Temperature Control And Adjustment .....	16
Electrical requirements.....	6	Thermostat setting button.....	16
Warning! This appliance must be earthed .....	6	Suggested Arrangement Of Food In The Fridge/Freezer .....	17
Energy saving tips.....	7	Storing Frozen Food .....	18
Compliance with WEEE Directive and Disposing of the Waste Product: .....	8	Freezing Fresh Food.....	18
Compliance with rohs directive: .....	8	Making Ice Cubes .....	18
Package information.....	8	Defrosting .....	19
<b>3 Installation</b>	<b>9</b>	<b>6 Maintenance and cleaning</b>	<b>20</b>
Transportation Instructions.....	9	<b>7 Do's and Don'ts</b>	<b>21</b>
Important.....	9	Problem Solving .....	22
Installation Instructions .....	9		
Changing the illumination lamp .....	11		
Reversing The Doors .....	12		
<b>4 Before operating</b>	<b>15</b>		
Final Check .....	15		

# 1 Your refrigerator

Congratulations on your choice of a **Beko** quality Appliance which has been designed to give you service for many years.

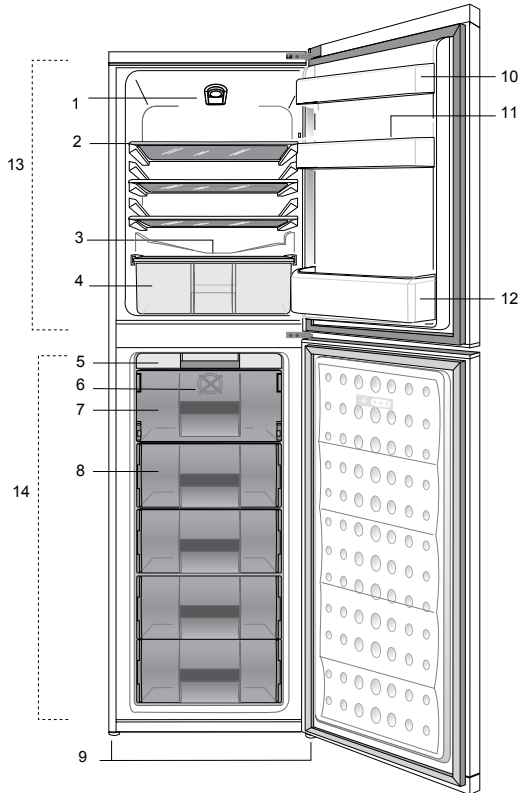

- |                                     |                                |
|-------------------------------------|--------------------------------|
| 1. Temperature setting knob         | 8. Frozen food storage drawers |
| 2. Cabinet shelves                  | 9. Adjustable feet             |
| 3. Defrost water collection channel | 10. Door shelves               |
| 4. Salad crisper                    | 11. Egg tray                   |
| 5. Ice bank                         | 12. Bottle shelf               |
| 6. Freezer fan                      | 13. Fridge compartment         |
| 7. Fast freeze compartment          | 14. Freezer compartment        |

**i** Figures that take place in this instruction manual are schematic and may not correspond exactly with your product. If the subject parts are not included in the product you have purchased, then it is valid for other models.

## 2 Warnings

---

- Do not connect your appliance to the electricity supply until all packing and transit protectors have been removed.
- If transported horizontally leave to stand upright for at least 4 hours before switching on to allow compressor oil to settle
- If you are discarding an old refrigerator with a lock or latch fitted to the door, disable the lock/latch, ensure that it is left in a safe condition to prevent the entrapment of young children.
- This fridge/freezer must only be used for its intended purpose i.e the storing and freezing of edible foodstuff.
- Do not dispose of the appliance on a fire. At **Beko**, the care and protection of our environment is an ongoing commitment. This appliance which is among the latest range introduced is particularly environment friendly. Your appliance contains non CFC / HFC natural substances in the cooling system (Called R600a) and in the insulation (Called cyclopentane) which are potentially flammable if exposed to fire. Therefore, take care not to damage, the cooling circuit / pipes of the appliance in transportation and in use. In case of damage do not expose the appliance to fire or potential ignition source and immediately ventilate the room where the appliance is situated.
- We suggest you contact your local authority for disposal information and facilities available.
- To obtain the best possible performance and trouble free operation from your appliance it is very important to carefully read these instructions.
- On delivery, check to make sure that the product is not damaged and that all the parts and accessories are in perfect condition.
- Ensure that the plug remains readily accessible. Do not use multiple adapter or extension cable.
- Failure to observe these instructions may invalidate your right to free service during the guarantee period.
- Keep ventilation openings, in the appliance enclosure or in the built-in structure, clear of obstruction.
- Do not damage the refrigerant circuit.
- Do not use electrical appliances inside the food storage compartments of the appliance, unless they are of the type recommended by the manufacturer.

- We suggest you keep these instructions in a safe place for easy reference.
- This appliance can be used by children aged from 8 years and above and persons with reduced physical, sensory or mental capabilities or lack of experience and knowledge if they have been given supervision or instruction concerning use of the appliance in a safe way and understand the hazards involved. Children shall not play with the appliance. Cleaning and user maintenance shall not be made by children without supervision.
- Children should be supervised to ensure that they do not play with the appliance.

## Electrical requirements

Before you insert the plug into the wall socket make sure that the voltage and the frequency shown on the rating plate inside the appliance corresponds to your electricity supply.

Rating label is on the left hand side of fridge inner liner.

We recommend that this appliance be connected to the mains supply via a suitable switched and fused socket. The appliance must be positioned so that the plug is accessible.

## WARNING:

When positioning the appliance ensure the supply cord is not trapped or damaged.

Should the mains lead of the appliance become damaged or should it need replacing at any time, it must be replaced by a special purpose made mains lead which can only be obtained from a **Beko** authorised service agent.

## Warning! This appliance must be earthed

If the fitted moulded plug is not suitable for your socket, then the plug should be cut off and an appropriate plug fitted. Destroy the old plug which is cut off as a plug with bared cord could cause a shock hazard if inserted into a socket elsewhere in the house.

The moulded plug on this appliance incorporates a 13 A fuse. Should the fuse need to be replaced an ASTABEAB approved BS 1362 fuse of the same rating must be used. Do not forget to refit the fuse cover. In the event of losing the fuse cover the plug must not be used until a replacement fuse cover has been fitted.

Colour of the replacement fuse cover must be the same colour as that visible on the pin face of the plug. Fuse covers are available from any good electrical store.

## Important! Fitting A Different Plug

1. As the colours of the wires in the mains lead of this appliance may not correspond with the coloured markings identifying the terminals in your plug proceed as follows: (See diagram).
2. Connect the green-yellow or green (Earth) wire to the terminal in the plug marked 'E' or with the symbol  $\oplus$  or coloured green and yellow or green.
3. Connect the blue (Neutral) wire to the terminal in the plug marked 'N' or coloured black.
4. Connect the brown (Live) wire to the terminal in the plug marked 'L' or coloured red.
5. With alternative plugs a 13 A fuse must be fitted either in the plug or adaptor or in the main fuse box. If in doubt contact a qualified electrician.

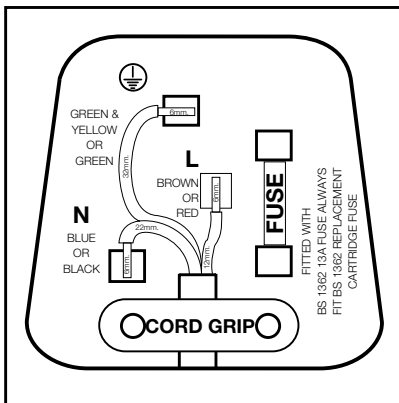

## Energy saving tips

1. Ensure your appliance is installed in a well ventilated area.
2. Ensure the time between buying chilled/frozen food and placing them in your appliance is kept at minimum, particularly in summer. We recommend you use a cool bag or a special carrier bag to carry perishable food.
3. Do not leave the door (s) of your appliance open longer than necessary and ensure they are closed properly after each opening.
4. Defrost frozen food in the fridge compartment, so that frozen food acts as an ice pack to assist cooling in the fridge.
5. Energy consumption of this appliance is measured while freezer compartment is loaded without use of top shelf lid and the drawers except the bottom drawer. It is advised that freezer compartment is loaded without use of drawers except the bottom drawer in order to achieve maximum loading capacity.

## **Compliance with WEEE Directive and Disposing of the Waste Product:**

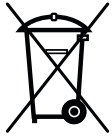

This product complies with EU WEEE Directive (2012/19/EU). This product bears a classification symbol for waste electrical and electronic equipment (WEEE). This product has been manufactured with high quality parts and materials which can be reused and are suitable for recycling. Do not dispose of the waste product with normal domestic and other wastes at the end of its service life. Take it to the collection center for the recycling of electrical and electronic equipment. Please consult your local authorities to learn about these collection centers.

## **Compliance with rohs directive:**

The product you have purchased complies with EU RoHS Directive (2011/65/EU). It does not contain harmful and prohibited materials specified in the Directive.

## **Package information**

Packaging materials of the product are manufactured from recyclable materials in accordance with our National Environment Regulations. Do not dispose of the packaging materials together with the domestic or other wastes. Take them to the packaging material collection points designated by the local authorities.



## 3 Installation

---

### Transportation Instructions

1. The appliance should be transported only in a vertical upright position. The packing as supplied must be intact during transportation.
2. If during the course of transport the appliance has to be transported horizontally, it must only be laid on its right hand side when standing in the front of the appliance. After bringing it to upright position, it must not be operated for at least 4 hours to allow the system to settle.
3. Failure to comply with the above instructions could result in damage occurring to the appliance. The manufacturer will not be held responsible if these instructions are disregarded.
4. The appliance must be protected against rain, moisture and other atmospheric influences.
5. When positioning your appliance take care not to damage your flooring, pipes, wall coverings etc. Do not move the appliance by pulling by the door or handle.
6. Empty any water in the drain tray before moving. See section 'Defrosting' and 'Care & cleaning' for further information.
7. Make sure that the defrost water pipe at the back of the product is fixed to the plastic evaporating pan on the top of the compressor, to avoid defrost water spillage on the floor.

### Important :

Care must be taken while cleaning /carrying the appliance to avoid touching the bottom of the condenser metal wires at the back of the appliance as you might injure your fingers and hands.

Do not attempt to sit or stand on top of your appliance as it is not designed for such use. You could injure yourself or damage the appliance.

### Important :

Make sure that mains cable is not caught under the appliance during and after carrying / moving the appliance, to avoid the mains cable becoming cut or damaged."

### Important :

This appliance is not designed for stacking with any other appliance. When positioning your appliance, take care not to damage your flooring, pipes, wall coverings etc.

Do not allow children to play with the appliance or tamper with the controls. **BEKO** declines to accept any liability should the instructions not be followed.

### Important

### Installation Instructions

1. The space in the room where the appliance is installed must not be smaller than 10 cubic metres.
2. This appliance has been designed to operate in ambient temperatures up to 32 degrees C (90 degrees F) and is equipped with Advanced Electronic Temperature Control System [AETCS] which

ensures that at the advised setting [4 - four on the knob] the frozen food in the freezer will not defrost even if the ambient temperature falls as low as -15 °C. When first installed the product MUST NOT be placed in low ambient temperatures because the freezer will not reduce to its standard operating temperature. Once it has reached its steady operating state it can be re-located. So you may then install your appliance in a garage or an unheated room without having to worry about frozen food in the freezer being spoilt. However at low ambient temperatures mentioned above, fridge contents are likely to freeze, so check and consume food in the fridge accordingly. When the ambient temperature returns to normal, you may change the knob setting to suit your needs. If the ambient temperature is below 0°C, the food in the fridge compartment will freeze. So, we recommend you don't use the fridge compartment in such low ambient conditions. You can continue using the freezer compartment as usual.

**3.** Do not place the appliance near cookers, radiators or in direct sunlight as this will cause your appliance to work harder. If installed next to a source of heat or freezer, maintain the following minimum side clearances:

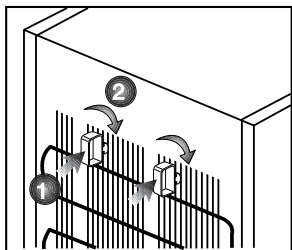

- From Cookers 50 mm (2")
- From Radiators 300 mm (12")
- From Freezers 25 mm (1")

**4.** Make sure that sufficient room is provided around the appliance to ensure free air circulation. Fit the Two plastic wall spacers supplied with the appliance rotating 1/4 turn to the condenser at the back of the appliance (See Diagram).

**5.** The fridge/freezer should be located on a smooth surface. The two front feet can be adjusted as required. To ensure that your appliance is standing upright adjust the two front feet by turning clockwise or anti-clockwise, until the product is in firm contact with the floor. Correct adjustment of feet avoids excessive vibration and noise.

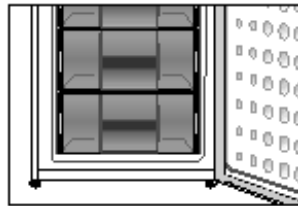

**6.** Refer to cleaning and care section to prepare your appliance for use. A special receptacle is supplied to store the mains plug during transit. The receptacle is fixed at the back of the cabinet, on the side of the compressor. (See diagram) Gently remove the plug from the receptacle. Never pull the mains cord, you may damage the appliance. In the case of transportation, ensure you locate the plug in the receptacle provided to avoid transit damage.

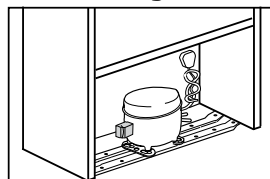

**WARNING:**

Do not locate extension sockets or charging transformers/power supplies or Lithium-Iron battery operated products adjacent to the compressor as they could overheat.

**Changing the illumination lamp**

To change the Bulb/LED used for illumination of your refrigerator, call your AuthorisedService.

The lamp(s) used in this appliance is not suitable for household room illumination. The intended purpose of this lamp is to assist the user to place foodstuffs in the refrigerator/freezer in a safe and comfortable way. The lamps used in this appliance have to withstand extreme physical conditions such as temperatures below -20 °C.

(only chest and upright freezer)

## Reversing The Doors

We recommend that you reverse doors before switching on for the first time.

Tools required: Small and medium size flat and cross-headed screwdrivers, a pair of pliers.

Spare Parts supplied in the plastic bag: The following parts, which are exclusively for left hand side fitted hinge operation are supplied in a plastic bag with the appliance:

- Upper door top trim hinge covers
- there are 2 different parts, one for each side of top trim.
- Upper door middle hinge bushing/ door stopper assembly.

We suggest you keep all the parts supplied in the plastic bag and also parts, which have been removed when reversing doors, in a safe place for possible future, re-use.

### **IMPORTANT:**

We suggest you ask somebody to help you when moving the appliance around and to hold doors when removing / re-fitting hinges and doors to avoid any injury and damage to the product.

Please refer to diagrams supplied. To follow numbers in brackets below, refer to the main diagram.

- 1.** Switch off the appliance at the socket outlet and pull out the mains plug.
- 2.** Remove all loose items and fittings and food, if any, from inside the appliance and door racks.
- 3.** Gently prise off plastic hinge cover of upper door top trim and hinge covers on both sides of front top panel using a small flat-headed screwdriver. (1)

- 4.** Gently tilt the appliance back against a strong wall on its rear side sufficiently to allow the lower hinge to be removed. Take care to protect the appliance, your wall and floor coverings. You can utilise the original packaging to do this. Once you tilt the appliance back, check to make sure the appliance is completely stable and safe before you carry on. (2)

- 5.** Unscrew and remove the lower hinge using a cross-headed screwdriver while holding the lower door firmly.(3)

- 6.** Remove lower door carefully off the middle hinge and stand door upright in a safe place.(4)

- 7.** Open upper door and unscrew and remove the middle hinge while holding the upper door firmly. Use a flat-headed screwdriver. Middle hinge will need to be rotated 180 degrees before re-fitting on the opposite side. (5)

- 8.** Remove upper door carefully off the upper hinge and stand door upright in a safe place.(6)

- 9.** Unscrew and remove the upper hinge using a flat-headed screwdriver.(7)

- 10.** Rotate the upper hinge 180 degrees and then unscrew and remove the hinge pin using a pair of pliers and re-fit to opposite side of hinge.(8)

- 11.** Reposition plugs and hinge pin bushings on top of doors on the opposite side of both doors. Use small flatheaded screwdrivers to remove plugs and bushings. Take care not to mark doors.(9)

**12.** Reposition left hand side feet on the opposite side.(10)

**Unscrew and remove the bottom door hinge pin bushing/door stopper using a cross-headed screwdriver. (11)Unscrew and remove the upper door middle hinge pin bushing/door stopper**

**using a cross-headed screwdriver.**

**IMPORTANT:**This part cannot be used on the opposite side; left hand side middle hinge pin bushing/door stopper part is supplied in the plastic bag.(11)

**13.** Re-fit the upper hinge on the left hand side using flat-headed screwdriver.(12)

**14.** Fit upper door left hand side middle hinge pin bushing/door stopper supplied in the plastic bag using cross-headed screwdriver.(13)

**15.** Reposition three small plastic plugs on the left hand side, which are covering middle hinge holes, on the opposite side to cover holes left empty.(14)

**16.** Locate and re-fit upper door to upper hinge and hold the door firmly.(15)

**17.** Locate the middle hinge pin to middle hinge pin bushing of upper door on the left hand side and re-fit the middle hinge.(16) First fit the left screw when the door is closed and then fit the right screw after opening the door for access.

**18.** Reposition the screw fitted to lower hinge hole on the left hand side at the bottom of the cabinet on the opposite side.(17)

**19.** Locate and re-fit lower door to middle hinge pin and then re-fit the lower hinge on the left hand side.(18),(19)

**20.** Carefully stand the appliance upright and adjust the two front feet if necessary.

**21.** Check that doors open and close easily, they are aligned correctly and that there are no gaps allowing air into the cabinet. If there are gaps between the door seal and the cabinet, adjust the door seal by gently pulling away from the door using fingers.

**22.** Check that all the hinge screws are tightened. Avoid over tightening the screws.

**23.** Put all items, fittings back in the appliance.

**24.** Fit upper door top trim and front top panel plastic hinge covers. Upper door top trim hinge covers are supplied in the plastic bag.(20)

**25.** Wait for at least 4 hours to allow the system to settle before switching on.

**26.** Once the correct storage temperatures have been reached in the appliance, put back all the food.

Scan to watch video showing how to reverse doors.

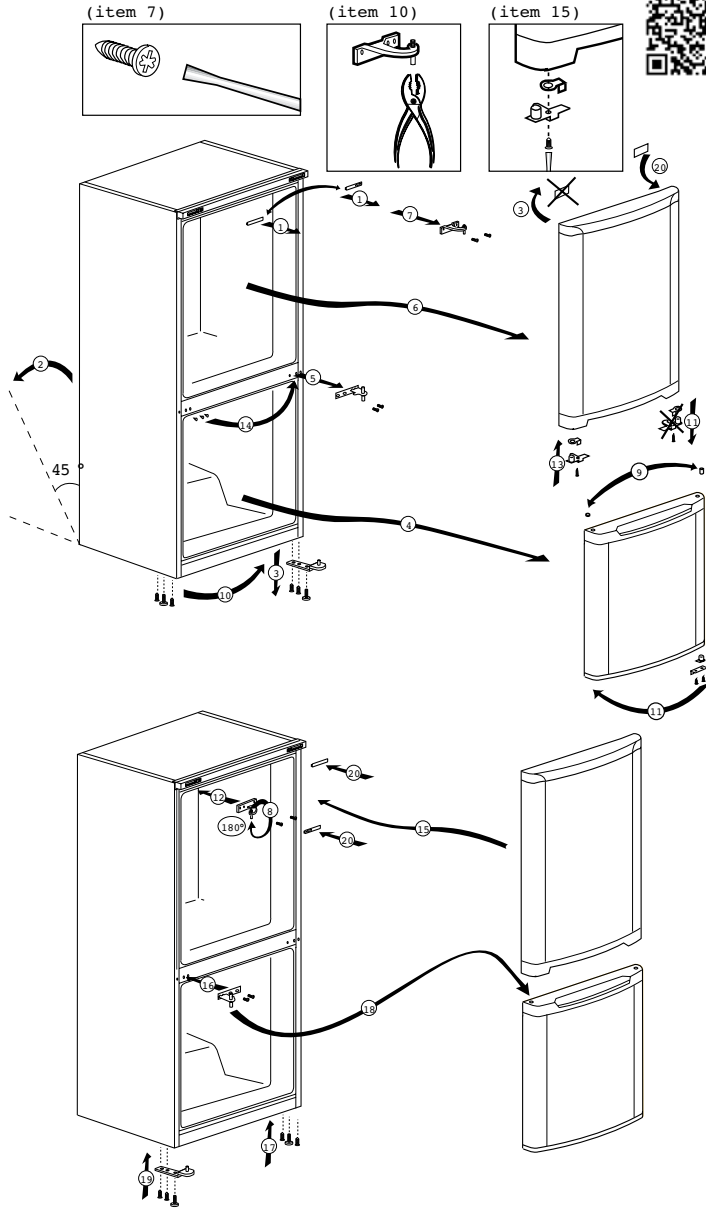

## 4 Before operating

---

### Final Check

Before you start using the fridge/freezer check that:

1. For a freestanding appliance; 'this refrigerating appliance is not intended to be used as a built-in appliance' ;
2. The feet have been adjusted for perfect levelling.
3. The interior is dry and air can circulate freely at the rear of the cabinet.
4. Clean the interior as recommended under "CLEANING AND CARE."
5. Insert the plug into the wall socket and switch on the electricity supply.
  - When the door is open the fridge interior light will come on.
6. You will hear a noise as the compressor starts up. The liquid and gases sealed within the refrigeration system may also give rise to noise, whether the compressor is running or not which is quite normal."Due to operation of the fan inside the frost free freezer compartment, overall noise level is slightly higher in comparison to non-frost free appliances. This is quite normal and is not a fault."
7. Set the setting knob half way between min and max.
8. Front edges of the cabinet may feel warm. This is normal. These areas are designed to be warm to avoid condensation.
9. Do not load the appliance immediately it is switched on. Wait until the correct storage temperature has been reached. We recommend that you check the temperature with an accurate thermometer (see; Temperature Control and Adjustment)"
10. When the freezer reaches the desired temperature the freezer fan will stop. When the freezer fan is on, the noise will be louder when the freezer door is opened.
11. Avoid spillage of food particularly small items like rice, peas, beans through the fan guard as they may cause the cooling system to block and therefore operate less efficiently.
12. Since hot and humid air will not directly penetrate into your product when the doors are not opened, your product will optimize itself in conditions sufficient to protect your food. In this energy saving function, functions and components such as compressor, fan, heater, defrost, lighting, display and so on will operate according to the needs to consume minimum energy while maintaining the freshness of your foodstuff.

## 5 Using your refrigerator

### Temperature Control And Adjustment

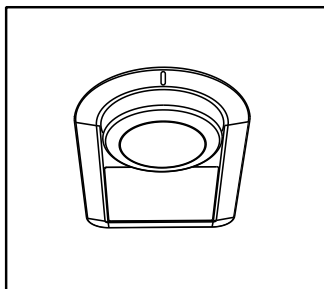

The operating temperature is regulated by the temperature control.

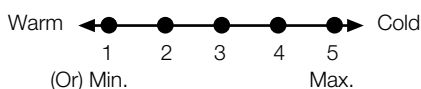

**1=Lowest cooling setting (Warmest setting).**

**5=Highest cooling setting (Coldest setting).**

The average temperature inside the fridge should be around +5°C.

Please choose the setting according to the desired temperature.

Please note that there will be different temperatures in the cooling area.

The coldest region is immediately above the vegetable compartment.

The interior temperature also depends on ambient temperature, the frequency with which the door is opened and the amount of foods kept inside.

Frequently opening the door causes the interior temperature to rise.

For this reason, it is recommended to close the door again as soon as possible after use.

### Thermostat setting button

The interior temperature of your refrigerator changes for the following reasons;

- Seasonal temperatures,
- Frequent opening of the door and leaving the door open for long periods,
- Food put into the refrigerator without cooling down to the room temperature,
- The location of the refrigerator in the room (e.g. exposing to sunlight).
- You may adjust the varying interior temperature due to such reasons by using the thermostat. Numbers around the thermostat button indicates the cooling degrees.
- If the ambient temperature is higher than 25°C, turn the thermostat button to maximum position.
- If the ambient temperature is lower than 25°C, turn the thermostat button to minimum position.



## Suggested Arrangement Of Food In The Fridge/ Freezer

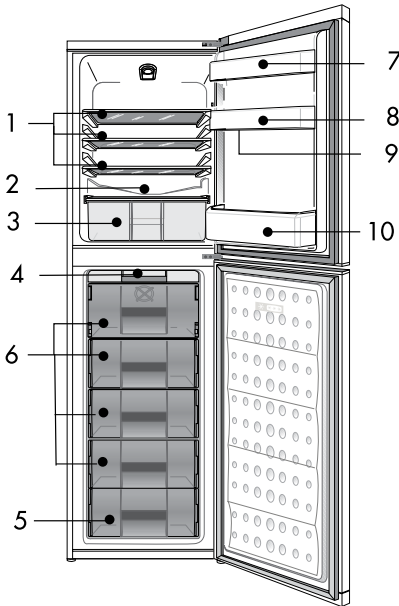

Arrangement Examples (See diagram)

1. Baked, chilled cooked food, dairy products, cans.
2. Meat, sausages, cold cuts.
3. Fruit, vegetables, salads.
4. Making, storing ice cubes.
5. Frozen food.
6. Frozen food and freezing of fresh food.
7. Butter, cheese.
8. Small bottles, cans, tubes.
9. Eggs.
10. Tall/Large bottles.

The following guidelines and recommendations are suggested to obtain the best results and storage hygiene.

**1.** The fridge compartment is for the short term storage of fresh food and drinks.

**2.** The freezer compartment is rated and suitable for the freezing of fresh food and storage of pre-frozen food. The recommendation for storage as stated on the food packaging should be observed at all times.

**3.** Cooked dishes must be stored in airtight covered containers.

**4.** Fresh wrapped produce can be placed on the shelf. Fresh fruit and vegetables should be cleaned and stored in the crisper bins.

**5.** Bottles can be placed in the door section.

**6.** To store raw meat, wrap in polythene bags and place on the lowest shelf. Do not allow to come into contact with cooked food to avoid contamination. For safety, only store raw meat for two to three days.

**7.** Keep the food packed wrapped or covered. Allow hot food and beverages to cool before placing them in the fridge. Do not store explosive substances. High proof alcohol must be stored upright in sealed containers. Left over canned food should not be stored in the can.

**8.** Fizzy drinks should not be frozen and products such as flavoured water ices should not be consumed too cold.

**9.** Some fruit and vegetables suffer damage if kept at temperatures near 0°C. Therefore wrap pineapples, melons, cucumbers, tomatoes and similar produce in polythene bags.

**10.** Place chilled cooked food and similar food near the rear of the fridge inner liner where the cold wall is located.

**11.** Shelves, racks, crisper bins, drawers, flaps, bottle grippers are all removable.

**12.** Do not leave frozen food at room temperature to thaw; the best way to defrost food is to put it in the fridge to thaw slowly. Make sure you avoid defrosting food or food juices drip onto other food.

**13.** For hygiene reasons, always wrap food using a suitable packaging material before storing in your appliance to avoid contact with the appliance surface.

## Storing Frozen Food

Prepacked commercially frozen food should be stored in accordance with the frozen food manufacturer's instructions for a  frozen food storage compartment.

To ensure that the high quality achieved by the frozen food manufacturer and the food retailer is maintained, the following should be remembered:

**1.** Put packets in the freezer as quickly as possible after purchase.

**2.** Ensure that contents are labelled and dated.

**3.** Do not exceed "Use By", "Best Before" dates on the packaging.

If there is a power failure do not open the door. Frozen food should not be affected if the failure lasts for less than 20 hrs. If the failure is longer, then the food should be checked and either eaten immediately or cooked and then re-frozen.

## Freezing Fresh Food

Please observe the following instructions to obtain the best results.

Do not freeze too large a quantity at any one time. The quality of the food is best preserved when it is frozen right through to the core as quickly as possible.

Do not exceed the freezing capacity of your appliance in 24 h which is 4 kg (8.8 lb)

Placing warm food into the freezer compartment causes the refrigeration compressor to operate continuously until the food is frozen solid. This can temporarily lead to excessive cooling of the refrigeration compartment.

When freezing fresh food turn the thermostat knob towards MAX. Small quantities of food up to 1/2 kg. (1 lb) can be frozen without having to rotate the temperature control knob.

You may place fresh food to be frozen in any part of the freezer.

Take special care not to mix already frozen food and fresh food.

## Making Ice Cubes

Fill the ice - cube tray 3/4 full with water and place it in the Ice Bank. Loosen frozen trays with the handle of a spoon, never use sharp edged objects such as knives, forks. Store ice-cubes in the Ice Bank.

Note: If freshly made ice cubes are not consumed for several weeks and stored in Ice Bank, they will slowly reduce in size and eventually disappear completely.

# Defrosting

## A) Fridge Compartment

The fridge compartment defrosts automatically. The defrosting water runs to the drain tube via a collection container at the back of the appliance (1). (see diagram) During defrosting water droplets may form at the back of the fridge compartment where concealed evaporator is located. Some droplets may remain on the liner and refreeze when defrosting is completed. Do not allow items in the fridge to touch the back wall as the water droplets will make them wet. Do not use pointed or sharp edged objects such as knives, forks to remove the droplets which have frozen.

If at any time the defrost water does not drain from the collection channel, check to ensure that no food particles have blocked the drain tube. The drain tube can be cleared by pushing the special plastic plunger provided down the drain tube (2). If the frost layer reaches about 1/4"(7 mm), reduce the setting (i.e. from 4 to 1) to restart automatic defrosting.

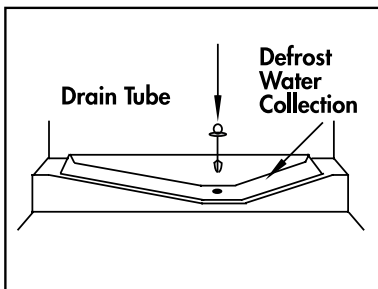

## B) Freezer Compartment

The freezer compartment defrosts automatically.

### Warnings!

- The fan inside the freezer compartment circulates cold air. Never insert any object through the guard. Do not allow children to play with the freezer fan.
- Never store products that contain inflammable propellant gas (eg dispensers, spray cans etc.) or explosive substances.
- Don't cover the shelves with any protective materials, which may obstruct air circulation.
- Do not allow children to play with the appliance or tamper with the controls.
- Do not obstruct the freezer fan guard to ensure that you obtain the best possible performance from your appliance.

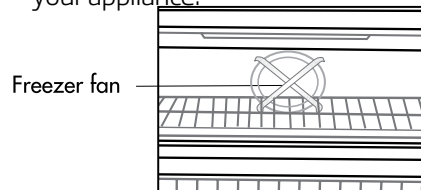

### Warning:

Do not use any copper pots or dishes inside the cabinet!

Do not load any food without packaging!

## 6 Maintenance and cleaning

---

- We recommend that you switch off the appliance at the socket outlet and pull out the mains plug before cleaning.
- Never use any sharp abrasive instrument, soap, household cleaner, detergent and wax polish for cleaning.
- Use luke warm water to clean the cabinet of the appliance and wipe it dry.
- Use a damp cloth wrung out in a solution of one teaspoon of bicarbonate of soda to one pint of water to clean the interior and wipe it dry.
- Make sure that no water enters the lamp housing.
- If the appliance is not going to be used for a long period of time switch it off, remove all food, clean it and leave the door ajar.
- Any dust that gathers on the condenser, which is located at the back of the appliance, should be removed once a year with a vacuum cleaner.
- Check door seals regularly to ensure they are clean and free from food particles.
- Removal of door tray
- To remove door racks, remove all the contents and then simply push the door rack upwards from the base.
- To remove a freezer drawer, pull it as far as possible, and then tilt it upwards, and then pull it out completely.
- To remove the freezer flap door, first open the door 3" and then gently pull it off. Make sure that the flap is in place before closing the freezer door.
- Make sure that the special plastic container (drain tray) at the back of the appliance which collects defrost water is clean at all times. If you want to remove the tray to clean it follow the instructions below :
  - Switch off at the socket outlet and pull out the mains plug.
  - Push the lug down with the tip of a screw driver & pull out with a jerk movement
  - Clean the drain tray and wipe it dry.
  - Reassemble reversing the sequence and operations.
  - Avoid spillage of food particularly small items like rice, peas, beans through the fan guard as they may cause the cooling system to block and therefore operate less efficiently.
- ⚠ Never use cleaning agents or water that contain chlorine to clean the outer surfaces and chromium coated parts of the product. Chlorine causes corrosion on such metal surfaces.

## 7 Do's and Don'ts

---

Do- Clean your appliance regularly (See "Cleaning and Care")

Do- Keep raw meat and poultry below cooked food and dairy products.

Do- Take off any unusable leaves on vegetables and wipe off any soil.

Do- Leave lettuce, cabbage, parsley and cauliflower on the stem.

Do- Wrap cheese firstly in greaseproof paper and then in a polythene bag excluding as much air as possible. For best results take out of the fridge compartment an hour before eating.

Do- Wrap raw meat and poultry loosely in polythene or aluminium foil. This prevents drying.

Do- Wrap fish and offal in polythene bags.

Do- Wrap food which have a strong odour or can dry out in polythene bags, aluminium foil or place in an airtight container.

Do- Wrap bread well to keep it fresh.

Do- Chill white wines, beer, lager and mineral water before serving.

Do- Check contents of the freezer every so often.

Do- Keep food for as short a time as possible and adhere to "Best Before", "Use by" etc. dates.

Do- Store commercially frozen food in accordance with the instructions given on the packets that you buy.

Do- Always choose high quality fresh food and be sure it is thoroughly clean before you freeze it.

Do- Prepare fresh food for freezing in small portions to ensure rapid freezing.

Do- Wrap all food in aluminium foil or freezer quality polythene bags and make sure any air is excluded.

Do- Wrap frozen food when you buy it and put it in to the freezer as soon as possible.

Do- Defrost food in the fridge compartment.

Do- Remove ice cream from the freezer 10-20 minutes before serving.

Don't- Store bananas in your fridge compartment.

Don't- Store melon in your fridge. It can be chilled for short periods as long as it is wrapped to avoid it flavouring other food.

Don't- Store poisonous or any dangerous substances in your appliance. It has been designed for the storage of edible foodstuffs only.

Don't- Consume food which has been stored for an excessive time in the fridge.

Don't- Store cooked and fresh food together in the same container. They should be packaged and stored separately.

Don't- Let defrosting food or food juices drip onto food.

Don't- Leave the door open for long periods as this will make the appliance more costly to run and cause excessive ice formation.

Don't- Put hot food into the appliance. Let it cool down first.

Don't- Put liquid-filled bottles or sealed cans containing carbonated liquids into the freezer as they may burst.

Don't- Exceed the maximum freezing loads (6 kg in any 24 hours) when freezing fresh food.

Don't- Give children ice-cream and water ices direct from the freezer. The low temperature may cause 'freezer burns' on lips.

Don't- Freeze fizzy drinks.

Don't- Try to keep frozen food which has thawed, it should be eaten within 24 hours or cooked and refrozen.

Don't- Remove items from the freezer with wet hands.

Don't- Close the freezer door before placing the compartment cover in its place.

Don't- Leave frozen food at room temperature to thaw; the best way to defrost food is to put it in the fridge to thaw slowly. Make sure you avoid defrosting food or food juices drip onto other food.

## Problem Solving

If the appliance does not operate when switched on, check whether:

- The plug is inserted properly in the socket and that the power supply is on. (To check the power supply to the socket, plug in another appliance)
- The fuse has blown/circuit breaker has tripped/main distribution switch has been turned off.
- The temperature control has been set correctly and not to "0" (OFF)
- New plug is wired correctly if you have changed the fitted moulded plug.

If the appliance is still not operating after the above checks, please refer to the section on "How To Obtain Service".

Please ensure that above checks have been made as a charge will be made if no fault is found.

## **BEKO UK AND IRELAND STANDARD MANUFACTURER GUARANTEE TERMS AND CONDITIONS**

Your new Beko product is guaranteed against faulty materials, defective components or manufacturing defects.

The standard guarantee starts from the date of original purchase of the product, and lasts for a period of twelve (12) months unless Beko plc (the "Manufacturer") agrees to extend the guarantee for the product in writing.

If you have purchased an American style Fridge freezer, the standard guarantee starts from the date of original purchase of the product, and lasts for a period of twenty four (24) months unless Beko plc (the "Manufacturer") agrees to extend the guarantee for the product in writing.

If you have any questions about the guarantee on your product (including how long it is valid), please contact your retailer or our contact centre on

**0333 207 971** (UK and Northern Ireland) or **01 862 3411** (Republic of Ireland)

This guarantee does not in any way diminish or affect your statutory rights in connection with the product. This guarantee is in addition to your statutory rights as a consumer. If you have any questions about these rights, please contact the retailer from which you purchased the product. In certain circumstances, it is possible that your statutory rights may offer additional or higher levels of protection than those offered under the terms of this guarantee.

### **What is covered by this guarantee?**

- Repairs to the product required as a result of faulty materials, defective components or manufacturing defects.
- Functional replacement parts to repair a product.
- The costs of a Beko Approved Engineer to carry out the repair.

### **What is not covered?**

- Transit and delivery damage.
- Cabinet or appearance parts, including but not limited to control knobs, flaps and handles.
- Accessories and/or consumable items including but not limited to ice trays, scrapers, cutlery baskets, filters and light bulbs.
- Repairs necessary as a direct or indirect result of:
  - Accidental damage, misuse or abuse of a product.
  - An attempted repair of a product by anyone other than a Beko Approved Engineer (the "Engineer").
  - Installation or use of a product where such installation or use fails to meet the requirements contained in this guarantee or the User Instructions Booklet.

- Repairs to a product operated at any time on commercial or non-residential household premises (unless we have previously agreed to the installation environment).

This guarantee is limited to the cost of repairing the product. To the extent permitted by law, the Manufacturer does not accept and will not be held liable for any financial loss incurred in connection with the failure of any product to operate in accordance with the expected standards. Such financial loss includes but is not limited to loss arising from:

- Time taken off work.
- Damaged food, clothing or other items.
- Meals taken at restaurants or from takeaways.
- General compensation for inconvenience.

### **Important Notes**

- 1.** Your product is designed and built for domestic household use only.
- 2.** The guarantee will automatically be void if the product is installed or is used in commercial or non-residential domestic household premises, unless we have previously agreed to the installation environment.
- 3.** The product must be correctly installed, located and operated in accordance with the instructions contained in the User Instructions Booklet provided with your product.
- 4.** Professional installation by a qualified Electrical Domestic Appliance Installer is recommended for all Washing Machines, Dishwashers and Electric Cookers (as incorrect installation may result in you having to pay for the cost of repairing the product).
- 5.** Gas Cookers must be professionally installed by a Gas Safe (or Gas Networks Ireland for Republic of Ireland) registered gas installer.
- 6.** This guarantee is given in respect of products purchased and used within the United Kingdom and the Republic of Ireland.
- 7.** This guarantee is effective from the initial date of purchase of a new product from an authorised retailer and will be void if the product is resold.
- 8.** This guarantee does not apply to graded sales (where the product is purchased as a "second").
- 9.** Possession of a copy of these terms and conditions does not necessarily mean that a product has the benefit of this guarantee. If you have any questions, please call our Call Centre on the number set out above.
- 10.** The Manufacturer reserves the right to terminate the guarantee if its staff or representatives are subjected to physical or verbal abuse in the course of carrying out their duties.
- 11.** Optional extras, where available (i.e. extendable feet) are supplied on a chargeable basis only.



## **Does Beko offer replacements?**

This is a repair-only guarantee. On occasion, the Manufacturer may at its sole discretion, replace your product with a new product instead of carrying out a repair. Where a replacement is offered, this would normally be an identical model but when this is not possible, a model of similar specification will be provided. The Manufacturer will cover the costs and arrange for the delivery of the new product and for the return of the old product. Any costs related to disconnecting the faulty product and installing the replacement product will not be borne by the Manufacturer unless previously agreed to in writing. The original guarantee will continue to apply to the replacement product; the new product will not come with a new guarantee.

## **When will the repair take place?**

Our Engineers work Monday to Friday 9.00am to 5.00pm. Appointments outside these hours may be possible at the sole discretion of the Manufacturer but cannot be guaranteed. Whilst our Engineers will endeavour to minimize inconvenience and to meet requests for specific timed appointments, this cannot be guaranteed. We will not be liable for delays or if it is unable to carry out a repair because a convenient appointment cannot be arranged.

## **Will there be any charge for the repairs?**

It is your responsibility to provide evidence to the Engineer that your product is covered by this guarantee with a proof of purchase. The Manufacturer reserves the right to charge for the reasonable cost of any service call if:

- You cannot provide evidence that your product is covered by this guarantee.
- Where a service call has been made and the engineer finds that there is no fault with your product.
- That your product has not been installed or operated in accordance with the User Instructions Booklet.
- That the fault was caused by something other than faulty materials, defective components or manufacturing defects.
- For missed appointments.

Payment of these costs are due immediately upon the Engineer providing you with an invoice. The Manufacturer reserves the right to terminate the guarantee if you fail to pay the costs for the service call in a timely manner.

If you are a resident of the United Kingdom, this guarantee will be governed by English law and subject to the English Courts, save where you live in another part of the United Kingdom, in which case the law and courts of that location will apply.

If you are resident in the Republic of Ireland, this guarantee will be governed by Irish law and the Irish courts will have jurisdiction.

This guarantee is provided by Beko plc. Beko House, 1 Greenhill Crescent, Watford, Hertfordshire. WD18 8QU.

Beko plc is registered in England and Wales with company registration number 02415578

## **BEKO UK AND IRELAND BUILT-IN APPLIANCES GUARANTEE TERMS AND CONDITIONS**

If you have purchased a built-in or integrated appliance, and registered it within 90 days of purchase by completing the online registration form, then the standard 12 month guarantee will be extended to 24 months, under the same terms and conditions as detailed in our Standard Guarantee Terms and Conditions.

### **HOW TO OBTAIN SERVICE FOR YOUR APPLIANCE**

Please keep your purchase receipt or other proof of purchase details in a safe place; you will need to have this documentation available should the product require attention under guarantee.

Please take a few moments to complete the details below, as you will need this information when you call us, or to use our online services. When you call us you may be required to input your serial number into your telephone keypad. For help please visit [beko.co.uk/support/model-finder](http://beko.co.uk/support/model-finder)

- The product model number is printed on the Operating Instruction Booklet / User guide
- The product model and serial number is printed on the Rating Label affixed to the appliance.
- The Retailer (Purchased from) and Date of purchase will be printed on your purchase receipt or other proof of purchase paperwork

Recording of these details alone will not count as proof of purchase. A valid proof of purchase is required for requesting service under guarantee.

Model number	Serial number	Purchased from	Date of purchase

## **For service under guarantee or for product advice please call our Contact centre**

Before requesting service please check the troubleshooting guide in the Operating Instructions booklet, as a charge may be levied where no fault is found, and even though your product may still be under guarantee.

After arranging service the area around the product must be easily accessible to the Engineer, without the need for cabinets or furniture to be removed or moved.

It is your responsibility to ensure our Engineers have a clean and safe environment to carry out any repairs.

Please have your Model number and Serial number available when you call us, as you may be required to input your serial number into your telephone keypad during your call.

### **UK Mainland & Northern Ireland:**

**0333 207 9710**

*Landline or mobile calls to 0333 numbers cost no more than calls to geographic numbers 01 or 02, and are charged at the basic rate. Calls from landlines and mobiles are included in free call packages but please check with your telephone service provider for exact call charges.*

### **Republic of Ireland:**

**01 862 3411**

### **Service once the manufacturers guarantee has expired**

*If you have purchased an extended guarantee please refer to the instructions contained within the extended guarantee agreement document, otherwise please call us using the appropriate number above, where service can be obtained at a charge.*

Should you experience any difficulty in obtaining service please call us on **0333 207 9710** or **01 862 3411**

### **Contact us through our website**

Send us a secure message through our online contact us form. Please visit our website, click Contact Us and choose a product support topic from the list of options. Complete the required details and click send message.

### **Product registrations**

For UK registrations please visit [beko.co.uk/register](http://beko.co.uk/register) and for the Republic of Ireland visit [beko.ie/register](http://beko.ie/register).

## DISCLAIMER / WARNING

Some (simple) failures can be adequately handled by the end-user without any safety issue or unsafe use arising, provided that they are carried out within the limits and in accordance with the following instructions (see the “Self-Repair” section).

Therefore, unless otherwise authorized in the “Self-Repair” section below, repairs shall be addressed to registered professional repairers in order to avoid safety issues. A registered professional repairer is a professional repairer that has been granted access to the instructions and spare parts list of this product by the manufacturer according to the methods described in legislative acts pursuant to Directive 2009/125/EC.

**However, only the service agent (i.e. authorized professional repairers) that you can reach through the phone number given in the user manual/warranty card or through your authorized dealer may provide service under the guarantee terms. Therefore, please be advised that repairs by professional repairers (who are not authorized by Beko) shall void the guarantee.**

### Self-Repair

Self-repair can be done by the end-user with regard to the following spare parts: door handles, door hinges, trays, baskets and door gaskets (an updated list is also available in support.beko.com as of 1st March 2021).

Moreover, to ensure product safety and to prevent risk of serious injury, the mentioned self-repair shall be done following the instructions in the user manual for self-repair or which are available in support.beko.com. For your safety, unplug the product before attempting any self-repair.

Repair and repair attempts by end-users for parts not included in such list and/or not following the instructions in the user manuals for self-repair or which are available in support.beko.com, might give rise to safety issues not attributable to Beko, and will void the warranty of the product.

Therefore, it is highly recommended that end-users refrain from the attempt to carry out repairs falling outside the mentioned list of spare parts, contacting in such cases authorized professional repairers or registered professional repairers. On the contrary, such attempts by end-users may cause safety issues and damage the product and subsequently cause fire, flood, electrocution and serious personal injury to occur.

By way of example, but not limited to, the following repairs must be addressed to authorized professional repairers or registered professional repairers: compressor, cooling circuit, main board, inverter board, display board, etc.

The manufacturer/seller cannot be held liable in any case where end-users do not comply with the above.

The spare part availability of the refrigerator that you purchased is 10 years.

During this period, original spare parts will be available to operate the refrigerator properly

The minimum duration of guarantee of the refrigerator that you purchased is 12 months.

This product is equipped with a lighting source of the “G” energy class.

The lighting source in this product shall only be replaced by professional repairers.