

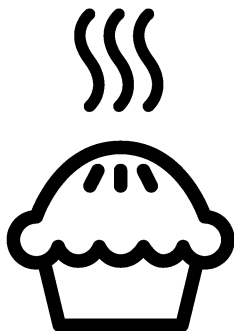

Built-in Oven

User Manual



BVR35500XMS

EN

285.4605.33/R.AF/8.03.2021

7768286724

Please read this user manual first!

Dear Customer,

Thank you for purchasing this Beko product. We hope that you get the best results from your product which has been manufactured with high quality and state-of-the-art technology. Therefore, please read this entire user manual and all other accompanying documents carefully before using the product and keep it as a reference for future use. If you handover the product to someone else, give the user manual as well. Follow all warnings and information in the user manual.

Remember that this user manual is also applicable for several other models. Differences between models will be identified in the manual.

Explanation of symbols

Throughout this user manual the following symbols are used:



Important information or useful hints about usage.



Warning of hazardous situations with regard to life and property.



Warning of electric shock.



Warning of risk of fire.



Warning of hot surfaces.



Arçelik A.Ş.
Karaağaç caddesi No:2-6
34445 Söğütözü/İstanbul/TURKEY
Made in TURKEY

TABLE OF CONTENTS

1 Important instructions and warnings for safety and environment 4

General safety.....	4
Electrical safety.....	5
Product safety.....	6
Intended use.....	8
Safety for children.....	8
Disposing of the old product.....	8
Package information.....	9

2 General information 10

Overview.....	10
Package contents.....	11
Technical specifications.....	12

3 Installation 13

Before installation.....	13
Installation and connection.....	14
Future Transportation.....	16

4 Preparation 17

Tips for saving energy.....	17
Initial use.....	17

Initial time setting.....	17
First cleaning of the appliance.....	18
Initial heating.....	18

5 How to operate the oven 19

General information on baking, roasting and grilling.....	19
How to operate the electric oven.....	19
Oven functions.....	21
How to operate the oven control unit	24
Cooking times table.....	38
Ready meals functions.....	42
Recipes for convenience food menus	45
How to operate the grill.....	53

6 Maintenance and care 56

General information.....	56
Cleaning the control panel.....	56
Cleaning the oven.....	56
Cleaning the oven door.....	58
Removing the door inner glass.....	59
Replacing the oven lamp.....	59

7 Troubleshooting 61

1 Important instructions and warnings for safety and environment

This section contains safety instructions that will help protect from risk of personal injury or property damage. Failure to follow these instructions shall void any warranty.

General safety

- This appliance can be used by children aged from 8 years and above and persons with reduced physical, sensory or mental capabilities or lack of experience and knowledge if they have been given supervision or instruction concerning use of the appliance in a safe way and understand the hazards involved.

Children shall not play with the appliance. Cleaning and user maintenance shall not be made by children without supervision.

- The appliance is not to be used by persons (including children) with reduced physical, sensory or mental capabilities, or lack of experience and knowledge,

unless they have been given supervision or instruction.

Children should be supervised and ensure they do not play with the appliance

- If the product is handed over to someone else for personal use or second-hand use purposes, the user manual, product labels and other relevant documents and parts should be also given.
- Installation and repair procedures must always be performed by Authorised Service Agents. The manufacturer shall not be held responsible for damages arising from procedures carried out by unauthorised persons which may also void the warranty. Before installation, read the instructions carefully.
- Do not operate the product if it is defective or has any visible damage.
- Ensure that the product function knobs are switched off after every use.

Electrical safety

- If the product has a failure, it should not be operated unless it is repaired by an Authorised Service Agent. There is the risk of electric shock!
- Only connect the product to a grounded outlet/line with the voltage and protection as specified in the “Technical specifications”. Have the grounding installation made by a qualified electrician while using the product with or without a transformer. Our company shall not be liable for any problems arising due to the product not being earthed in accordance with the local regulations.
- Never wash the product by spreading or pouring water onto it! There is the risk of electric shock!
- The product must be disconnected during installation, maintenance, cleaning and repairing procedures.
- If the power connection cable for the product is damaged, it must be replaced by the manufacturer, its service agent or similarly qualified persons in order to avoid a hazard.
- The appliance must be installed so that it can be completely disconnected from the mains supply. The separation must be provided by a switch built into the fixed electrical installation, according to construction regulations.
- Rear surface of the oven gets hot when it is in use. Make sure that the electrical connection does not contact with the rear surface; otherwise, connections can get damaged.
- Do not trap the mains cable between the oven door and frame and do not route it over hot surfaces. Otherwise, cable insulation may melt and cause fire as a result of short circuit.
- Any work on electrical equipment and systems should only be carried out by authorised and qualified persons.
- In case of any damage, switch off the product and disconnect it from the mains.

To do this, turn off the fuse at home.

- Make sure that fuse rating is compatible with the product.

Product safety

- **WARNING:** The appliance and its accessible parts become hot during use. Care should be taken to avoid touching heating elements. Children less than 8 years of age shall be kept away unless continuously supervised.
- Never use the product when your judgment or coordination is impaired by the use of alcohol and/or drugs.
- Be careful when using alcoholic drinks in your dishes. Alcohol evaporates at high temperatures and may cause fire since it can ignite when it comes into contact with hot surfaces.
- Food Poisoning Hazard: Do not let food sit in oven for more than 1 hour before or after cooking. Doing so can result in food poisoning or sickness.
- Do not place any flammable materials close to the product as the sides may become hot during use.
- During use the appliances becomes hot. Care should be taken to avoid touching heating elements inside the oven.
- Keep all ventilation slots clear of obstructions.
- Do not heat closed tins and glass jars in the oven. The pressure that would build-up in the tin/jar may cause it to burst.
- Do not place baking trays, dishes or aluminium foil directly onto the bottom of the oven. The heat accumulation might damage the bottom of the oven.
- Do not use harsh abrasive cleaners or sharp metal scrapers to clean the oven door glass since they can scratch the surface, which may result in shattering of the glass.
- Do not use steam cleaners to clean the appliance as this may cause an electric shock.
- (Varies depending on the product model.) Placing the wire shelf and tray onto the wire racks properly

It is important to place the wire shelf and/or tray onto the rack properly. Slide the wire shelf or tray between 2 rails and make sure that it is balanced before placing food on it (Please see the following figure).

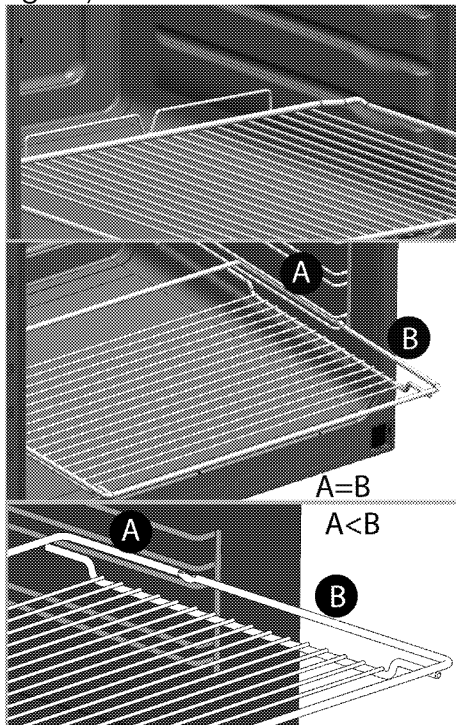

- Do not use the product if the front door glass is removed or cracked.
- Always use heat resistant oven gloves when putting in or removing dishes into/from the hot oven.
- Place the baking paper into the cooking pot or on to the

oven accessory (tray, wire grill etc) together with the food and then insert all into the preheated oven. Remove the excess parts of the baking paper overflowing from the accessory or the pot in order to prevent the risk of touching the oven's heating elements. Never use the baking paper in an operating temperature higher than the indicated value for the baking paper. Do not place the baking paper directly on the base of the oven.

- **WARNING:** Ensure that power cord of the appliance is unplugged or circuit breaker is switched off before replacing the lamp to avoid the possibility of electric shock.

- The appliance must not be installed behind a decorative door in order to avoid overheating.

Prevention against possible fire risk!

- Ensure all electrical connections are secure and tight to prevent risk of arcing.
- Do not use damaged cables or extension cables.

- Ensure liquid or moisture is not accessible to the electrical connection point.

Intended use

- This product is designed for domestic use. Commercial use will void the guarantee.
- **CAUTION:** This appliance is for cooking purposes only. It must not be used for other purposes, for example room heating.
- This product should not be used for warming the plates under the grill, drying towels, dish cloths etc. by hanging them on the oven door handles. This product should also not be used for room heating purposes.
- The manufacturer shall not be liable for any damage caused by improper use or handling errors.
- The oven can be used for defrosting, baking, roasting and grilling food.

Safety for children

- **WARNING:** Accessible parts may become hot during use. Young children should be kept away.
- The packaging materials will be dangerous for children.

Keep the packaging materials away from children. Please dispose of all parts of the packaging according to environmental standards.

- Electrical products are dangerous to children. Keep children away from the product when it is operating and do not allow them to play with the product.
- Do not place any items above the appliance that children may reach for.
- When the door is open, do not load any heavy object on it and do not allow children to sit on it. It may overturn or door hinges may get damaged.

Disposing of the old product

Compliance with the WEEE Directive and Disposing of the Waste Product:



This product complies with EU WEEE Directive (2012/19/EU). This product bears a classification symbol for waste electrical and electronic equipment (WEEE).

This product has been manufactured with high quality parts and materials which can be reused and are suitable for recycling. Do not dispose of the waste product with normal domestic and other wastes at the end of its service life. Take it to the collection center for the

recycling of electrical and electronic equipment. Please consult your local authorities to learn about these collection centers.

Compliance with RoHS Directive:

The product you have purchased complies with EU RoHS Directive (2011/65/EU). It does not contain harmful and prohibited materials specified in the Directive.

Package information

- Packaging materials of the product are manufactured from recyclable materials in accordance with our National Environment Regulations. Do not dispose of the packaging materials together with the domestic or other wastes. Take them to the packaging material collection points designated by the local authorities.

2 General information

Overview

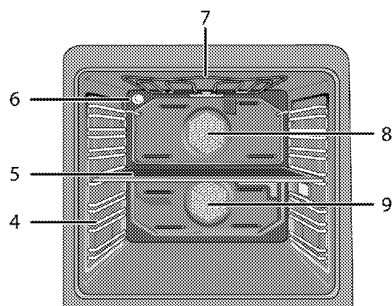
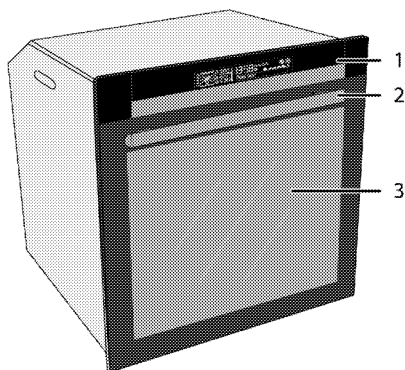

- | | |
|------------------------|--|
| 1 Control panel | 7 Top heating element |
| 2 Handle | 8 Top section fan motor (behind the sheet iron) |
| 3 Front door | 9 Bottom section fan motor (behind the sheet iron) |
| 4 Shelf positions | |
| 5 Middle section plate | |
| 6 Lamp | |

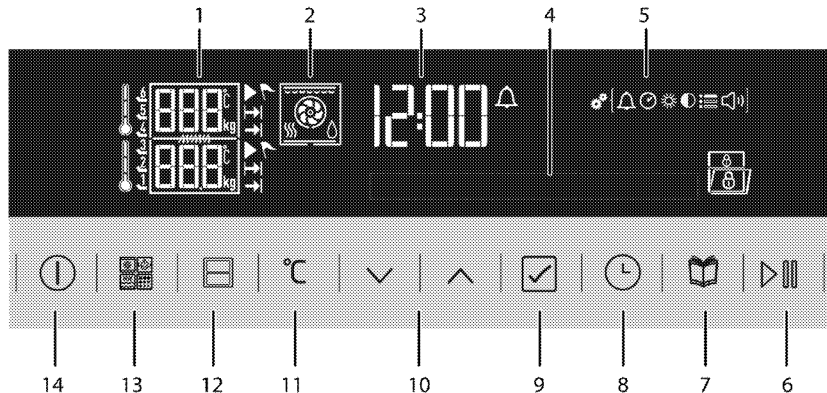

- | | |
|---------------------------------------|--|
| 1 Temperature/weight indicator field | 10 Up/down keys (Menu step) (Menu selection) |
| 2 Function display | 11 Temperature/weight/booster setting key |
| 3 Current time indicator field | 12 Oven section selection key |
| 4 Text display | 13 Function selection key * |
| 5 Settings menu symbols | 14 ON/OFF key |
| 6 Start/stop cooking key | * Present in ovens with self-cleaning, steamer and microwave properties. |
| 7 Convenience food menu selection key | |
| 8 Time and settings key | |
| 9 Confirmation key | |

10/EN

Package contents

i Accessories supplied can vary depending on the product model. Not every accessory described in the user manual may exist on your product.

1. User manual

2. Standard tray

Used for pastries, frozen foods and big roasts.

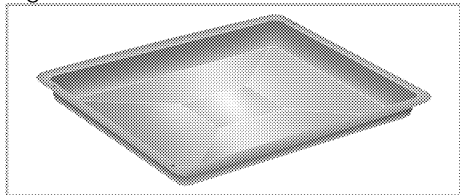

3. Deep tray

Used for pastries, large roasts, juicy dishes, and for collecting the fat while grilling.

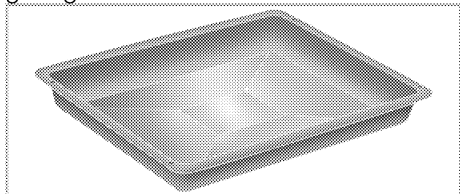

4. Wire grill

Used for roasting and for placing the food to be baked, roasted or cooked in casserole dishes to the desired rack.

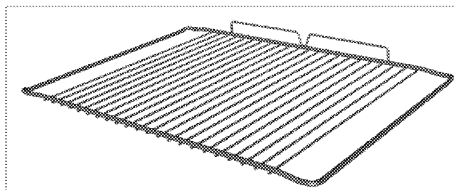
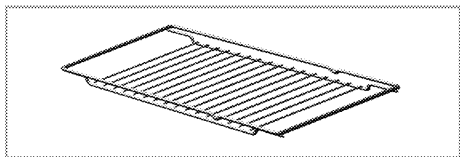

5. Placing the wire shelf and tray onto the telescopic racks properly (This feature is optional. It may not exist on your product.)

Telescopic racks allow you to install and remove the trays and wire shelf easily.

When using the tray and wire shelf with telescopic racks, make sure that the pins at the rear section of the telescopic rack stands against the edges of the wire shelf and tray.

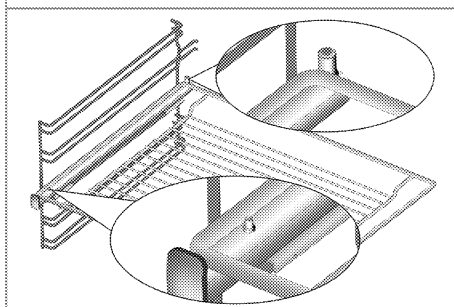
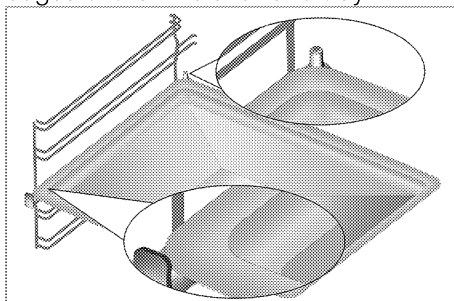

Technical specifications

Voltage / frequency	220-240 V ~ 50 Hz
Total power consumption	3,5 kW
Cable type / section	min.H05VV-FG 3 x 1,5 mm ²
External dimensions (height / width / depth)	595 mm/594 mm/567 mm
Installation dimensions (height / width / depth)	**590 or 600 mm/560 mm/min. 550 mm
Main oven	Multifunction oven - Dual section oven
Inner lamp	15/25 W
Grill power consumption	2.2 kW

Basics: Information on the energy label of electrical ovens is given in accordance with the EN 60350-1 / IEC 60350-1 standard. Those values are determined under standard load with bottom-top heater or fan assisted heating (if any) functions.

Energy efficiency class is determined in accordance with the following prioritization depending on whether the relevant functions exist on the product or not. 1-Cooking with eco-fan, 2- Turbo slow cooking, 3- Turbo cooking, 4- Fan assisted bottom/top heating, 5-Top and bottom heating.

** See. *Installation*, page 13.

i Technical specifications may be changed without prior notice to improve the quality of the product.

i Figures in this manual are schematic and may not exactly match your product.

i Values stated on the product labels or in the documentation accompanying it are obtained in laboratory conditions in accordance with relevant standards. Depending on operational and environmental conditions of the product, these values may vary.

3 Installation

Product must be installed by a qualified person in accordance with the regulations in force. The manufacturer shall not be held responsible for damages arising from procedures carried out by unauthorized persons which may also void the warranty.

 Preparation of location and electrical installation for the product is under customer's responsibility.

 The product must be installed in accordance with all local electrical regulations.

 Prior to installation, visually check if the product has any defects on it. If so, do not have it installed. Damaged products cause risks for your safety.

Before installation

The appliances must not be installed behind a decorative door in order to avoid overheating.

The appliance is intended for installation in commercially available kitchen cabinets. A safety distance must be left between the appliance and the kitchen walls and furniture. See figure (values in mm).

- Surfaces, synthetic laminates and adhesives used must be heat resistant (100 °C minimum).
- Kitchen cabinets must be set level and fixed.
- If there is a drawer beneath the oven, a shelf must be installed in order to separate from the oven and drawer.
- Carry the appliance with at least two persons.
- Hold the oven from the slots for handling on both sides to move it.
- Before installing the product, remove all materials and documents inside.
- Kitchen furniture must be in compliance with the dimensions given in the figure below. At the rear section of the kitchen furniture, an opening must be cut out with the dimensions given in the figure below to ensure sufficient ventilation.
-  Do not install the appliance next to refrigerators or freezers. The heat emitted by the appliance will lead to an increased energy consumption of cooling appliances.
-  The door and/or handle must not be used for lifting or moving the appliance.

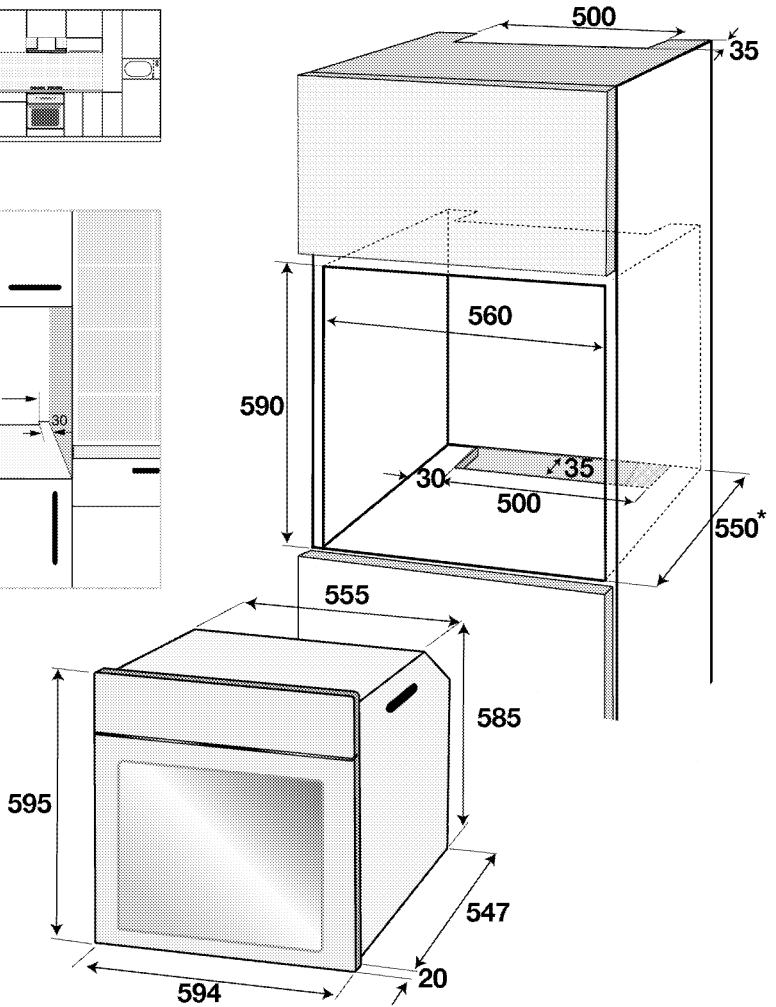
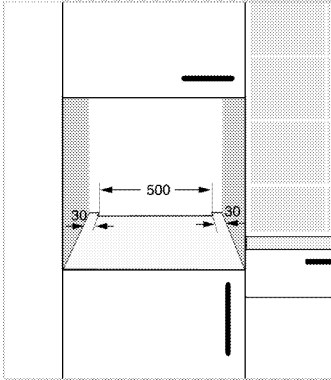
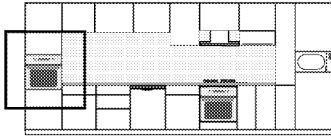

* min.

Installation and connection

- The product must be installed in accordance with all local gas and electrical regulations.

Electrical connection

Connect the product to a grounded outlet/line protected by a miniature circuit breaker of suitable capacity as stated in the "Technical specifications" table. Have the grounding installation

made by a qualified electrician while using the product with or without a transformer. Our company shall not be liable for any damages that will arise due to using the product without a grounding installation in accordance with the local regulations.

! The product must be connected to the mains supply only by an authorised and qualified person. The product's warranty period starts only after correct installation.

Manufacturer shall not be held responsible for damages arising from procedures carried out by unauthorised persons.

! The power cable must not be clamped, bent or trapped or come into contact with hot parts of the product.

A damaged power cable must be replaced by a qualified electrician. Otherwise, there is risk of electric shock, short circuit or fire!

- Connection must comply with national regulations.
- The mains supply data must correspond to the data specified on the type label of the product. Open the front door to see the type label.
- Power cable of your product must comply with the values in "Technical specifications" table.

! Before starting any work on the electrical installation, disconnect the product from the mains supply. There is the risk of electric shock!

Connecting the power cable

i While performing the wiring, you must apply with the national/local electrical regulations and must use the appropriate socket outlet/line and plug for oven. In case of the product's power limits are out of current carrying capability of plug and socket outlet/line, the product must be connected through fixed electrical installation directly without using plug and socket outlet/line.

1. If it is not possible to disconnect all poles in the supply power, a disconnection unit with at least 3 mm contact clearance (fuses, line safety switches, contactors) must be connected and all the poles of this disconnection unit must be adjacent to (not above) the product in accordance with IEE directives. Failure to obey this instruction may cause operational problems and invalidate the product warranty.

Additional protection by a residual current circuit breaker is recommended.

If a cable is supplied with the product:

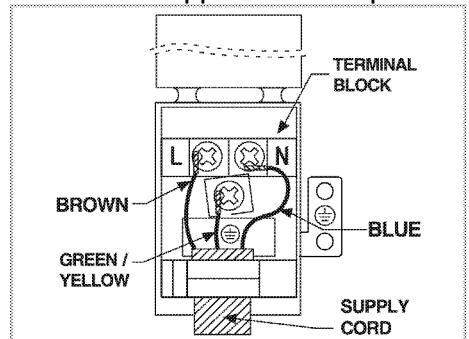

2. For single-phase connection, connect the wires as identified below:

- Brown/Black cable = L (Phase)
 - Blue/Grey cable = N (Neutral)
 - Green/yellow cable = (E) \oplus (Ground)
- » or

- Grey/Black cable = L (Phase)
- Blue/Brown cable = N (Neutral)
- Green/yellow cable = (E)  (Ground)

Installing the product

1. Slide the oven into the cabinet, align and secure it while making sure that the power cable is not broken and/or trapped.

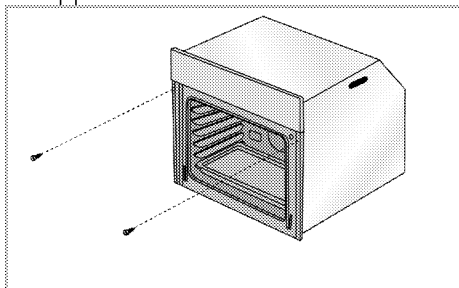

Secure the oven with 2 screws as illustrated.

After the installation, make sure that the screws are sufficiently tightened and the oven does not move. Oven may tip over during use if it is not installed as per the instructions and if the screws are not sufficiently tightened.

For products with cooling fan (This may not exist on your product.)

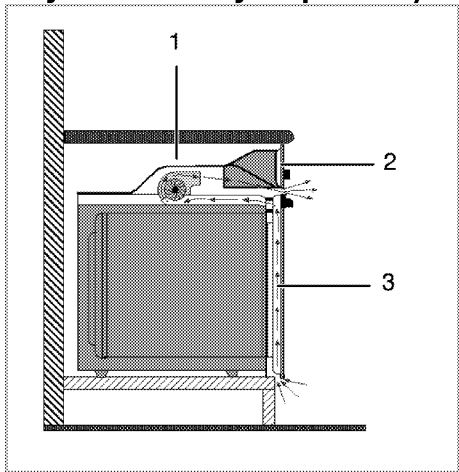

- 1 Cooling fan

- 2 Control panel

- 3 Door

The built-in cooling fan cools both the built-in cabinet and the front of the product.

- i** Cooling fan continues to operate for about 20-30 minutes after the oven is switched off.

If you have cooked by programming the timer of the oven, cooling fan will also be switched off at the end of the cooking time together with all functions.

Final check

1. Operate the product.
2. Check the functions.

Future Transportation

- Keep the product's original carton and transport the product in it. Follow the instructions on the carton. If you do not have the original carton, pack the product in bubble wrap or thick cardboard and tape it securely.
- To prevent the wire grill and tray inside the oven from damaging the oven door, place a strip of cardboard onto the inside of the oven door that lines up with the position of the trays. Tape the oven door to the side walls.
- Do not use the door or handle to lift or move the product.
- i** Do not place any objects onto the product and move it in upright position.
- i** Check the general appearance of your product for any damages that might have occurred during transportation.

4 Preparation

Tips for saving energy

The following information will help you to use your appliance in an ecological way, and to save energy:

- Use dark coloured or enamel coated cookware in the oven since the heat transmission will be better.
- While cooking your dishes, perform a preheating operation if it is advised in the user manual or cooking instructions.
- Do not open the door of the oven frequently during cooking.

Initial use

Initial time setting

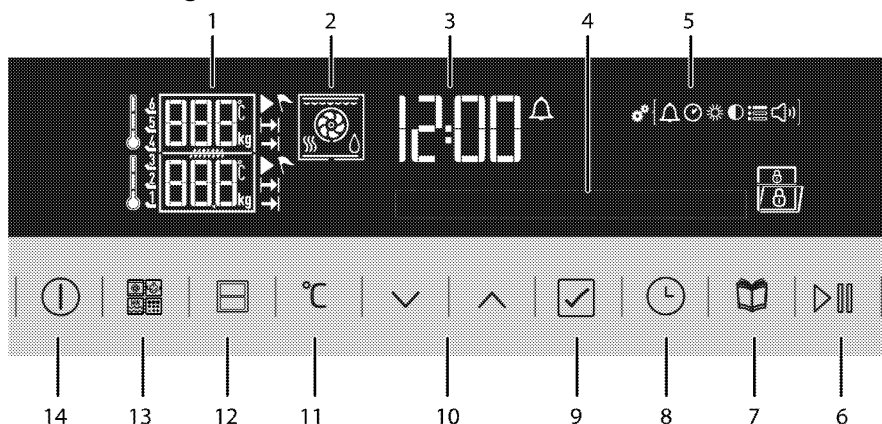

- 1 Temperature/weight indicator field
- 2 Function display
- 3 Current time indicator field
- 4 Text display
- 5 Settings menu symbols
- 6 Start/stop cooking key
- 7 Convenience food menu selection key
- 8 Time and settings key
- 9 Confirmation key
- 10 Up/down keys (Menu step) (Menu selection)
- 11 Temperature/weight/booster setting key
- 12 Oven section selection key
- 13 Function selection key *
- 14 ON/OFF key

- Try to cook more than one dish in the oven at the same time whenever possible. You can cook by placing two cooking vessels onto the wire shelf.
- Cook more than one dish one after another. The oven will already be hot.
- You can save energy by switching off your oven a few minutes before the end of the cooking time. Do not open the oven door.
- Defrost frozen dishes before cooking them.

* Present in ovens with self-cleaning, steamer and microwave properties.

Set the initial time

1. When you switch on the product for the first time, hour field and ⌚ symbol flash. "Set the current time" text will be displayed.



2. Set the hour field with ^/v keys.
3. Touch [✓] to confirm the hour.
4. Minute field and ⌚ symbol flash. Set the minute with ^/v keys. Touch to [✓] confirm the minute.

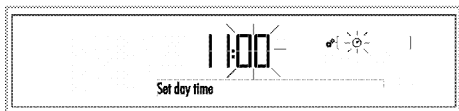

» It returns to the stand-by display. Only the current time appears on the display.

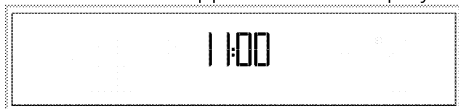

Language setting

Language can only be set when the oven is on stand-by display.

1. Touch key until you see symbol in settings menu.

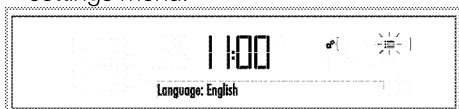

2. symbol flashes on the display and set language option will be displayed.

3. Touch keys to select the desired language.

4. Touch to confirm the setting.

» It returns to the stand-by display. Only the current time appears on the display.

» Only the and keys are functional when the display is in this status. You can perform all actions in the Settings menu.

In case of power outage or when the product is disconnected and reconnected in again, time setting menu is displayed again.

First cleaning of the appliance

The surface might get damaged by some detergents or cleaning materials.

Do not use aggressive detergents, cleaning powders/creams or any sharp objects during cleaning.

Do not use harsh abrasive cleaners or sharp metal scrapers to clean the oven door glass since they can scratch the surface, which may result in shattering of the glass.

1. Remove all packaging materials.

2. Wipe the surfaces of the appliance with a damp cloth or sponge and dry with a cloth.

Initial heating

Heat up the product for about 30 minutes and then switch it off. Thus, any production residues or layers will be burnt off and removed.



Hot surfaces cause burns!

Product may be hot when it is in use. Never touch the hot burners, inner sections of the oven, heaters and etc. Keep children away.

Always use heat resistant oven gloves when putting in or removing dishes into/from the hot oven.

Electric oven

1. Take all baking trays and the wire grill out of the oven.

2. Close the oven door.

3. Select Static position.

Grill oven

1. Take all baking trays and the wire grill out of the oven.

2. Close the oven door.

3. Select the highest grill power; see .

4. Operate the grill about 15 minutes.

5. Turn off your grill; see



Smoke and smell may emit for a couple of hours during the initial operation. This is quite normal. Ensure that the room is well ventilated to remove the smoke and smell. Avoid directly inhaling the smoke and the smell that emits.

5 How to operate the oven

General information on baking, roasting and grilling



Hot surfaces cause burns! Product may be hot when it is in use. Never touch the hot burners, inner sections of the oven, heaters and etc. Keep children away. Always use heat resistant oven gloves when putting in or removing dishes into/from the hot oven.



Be careful when opening the oven door as steam may escape. Exiting steam can scald your hands, face and/or eyes.

Tips for baking

- Use non-sticky coated appropriate metal plates or aluminum vessels or heat-resistant silicone moulds.
- Make best use of the space on the rack.
- Place the baking mould in the middle of the shelf.
- Select the correct rack position before turning the oven or grill on. Do not change the rack position when the oven is hot.
- Keep the oven door closed.

Tips for roasting

- Treating whole chicken, turkey and large piece of meat with dressings such as lemon juice and black pepper before cooking will increase the cooking performance.
- It takes about 15 to 30 minutes longer to roast meat with bones when compared to roasting the same size of meat without bones.
- Each centimeter of meat thickness requires approximately 4 to 5 minutes of cooking time.
- Let meat rest in the oven for about 10 minutes after the cooking time is over. The juice is better distributed all over the

roast and does not run out when the meat is cut.

- Fish should be placed on the middle or lower rack in a heat-resistant plate.

Tips for grilling

When meat, fish and poultry are grilled, they quickly get brown, have a nice crust and do not get dry. Flat pieces, meat skewers and sausages are particularly suited for grilling as are vegetables with high water content such as tomatoes and onions.

- Distribute the pieces to be grilled on the wire shelf or in the baking tray with wire shelf in such a way that the space covered does not exceed the size of the heater.
- Slide the wire shelf or baking tray with grill into the desired level in the oven. If you are grilling on the wire shelf, slide the baking tray to the lower rack to collect fats. The baking tray to be slid must be of a size that covers the whole grilling area. This tray might not be provided with the product. Add some water in the baking tray for easy cleaning.



Foods that are not suitable for grilling carry the risk of fire. Only grill food which is suitable for intensive grilling heat.

Do not place the food too far in the back of the grill. This is the hottest area and fatty food may catch fire.





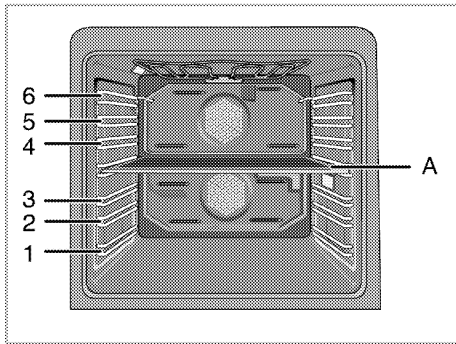

How to operate the electric oven

Rack positions

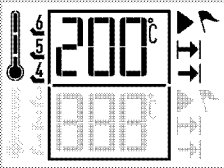
There are 6 racks suitable for use in your oven, 3 of which are in lower section and 3 of which are in upper section. There is another canal in the gap where middle section plate (A) will be installed. Do not use this canal as a rack while cooking.

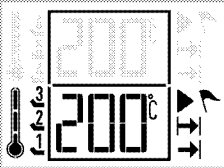
You can cook in 4 different sections of your oven.

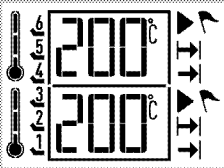

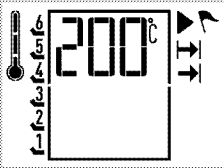





	Upper section	You can only cook in upper section. It is suitable for grill and small sized items.		When upper section is active, temperature value, rack positions, cooking symbol, stand-by symbol, cooking time symbol and cooking end time symbol of this section appear on the display.
	Lower section	You can only cook in lower section. It is suitable for medium sized items.		When upper section is active, temperature value, rack positions, cooking symbol, stand-by symbol, cooking time symbol and cooking end time symbol of this section appear on the display.
	Lower-upper section	You can cook simultaneously in lower and upper sections. It is suitable for cooking two different dishes.		When lower-upper section is active, temperature value, rack positions, cooking symbol, stand-by symbol, cooking time symbol and cooking end time symbol of these sections appear on the display separately.
	Single large section	You can cook in single large section. It is suitable for large sized and multiple items.		When single large section is active, temperature value, rack positions, cooking symbol, stand-by symbol, cooking time symbol and cooking end time symbol of this section appear on the display.

Oven functions

The order of operating modes shown here may be different from the arrangement on your product. These functions apply to oven with a single large section only. All oven functions of your oven are explained in this section.

Symbol	Name	Description
	Static (Top and bottom heating)	Top and bottom heaters are in operation simultaneously. Cook with one tray only.
	Bottom heating	Only bottom heater is in operation. It is suitable for pizza and for subsequent browning of food from the bottom.
	Static+fan (Fan supported bottom/top heating)	Top heater, bottom heater plus fan (in the rear wall) are in operation. Hot air is evenly distributed throughout the oven rapidly by means of the fan. Cook with one tray only.
	Defrost (Fan operated)	The oven is not heated. Only the fan (in the rear wall) is in operation. Suitable for thawing frozen granular food slowly at room temperature and cooling down the cooked food. The time required to thaw a whole piece of meat is longer than the food with grains.
	Fan assisted cooking	Only the fan heater in the rear wall is in operation. Hot air heated by the fan heater is evenly distributed throughout the oven rapidly by means of the fan. In most cases, preheating is not required.
	Top heater+fan (Fan assisted top heating)	Top heater and the fan heater at the rear wall are in operation. Hot air is distributed better with fan compared to the situation where only top heating is in operation.
	Pizza	Bottom heater and the fan assisted heater (at the rear wall) are in operation simultaneously. Suitable for baking pizza.
	Multi "3D" cooking	Top heater, bottom heater and the fan assisted heater are in operation simultaneously. Cook with one tray only.
	Economic grill	Only the inner section of the top heater at oven ceiling operates. Suitable for grilling small and medium sizes of meat.
	Full grill	Inner and outer sections of the top heater at oven ceiling are in operation simultaneously. Suitable for grilling medium size meat pieces.
	Grill + Fan (Fan supported grill)	Rear wall fan operates along with the inner and outer sections of the top heater at oven ceiling. Hot air is evenly distributed throughout the oven rapidly by means of the fan. Suitable for grilling medium size meat pieces.

Symbol	Name	Description
	Warm keeping	Used for keeping food at a temperature ready for serving for a long period of time. Do not use for cooking food.
	Eco fan cooking	Only the fan heater in the rear wall is in operation. To save power, you can use this function instead of the cooking operations that you would perform by using Fan Heating at 160-220oC temperature range. But, the cooking time will increase a little bit. Cooking times related to this function are indicated in "Eco Fan Cooking" table.
	Low temperature cooking	Food is heated simultaneously from the top and bottom. It is suitable for slow-cooking of roasted/seared pieces of meat (veal, lamb, poultry etc.) in an open container at low temperature. This function ensures that the meat is juicy and soft on the inside. Please use hygienically suitable types of meat. On the hob, grill etc., preroast/sear all surfaces of the meat in a hot pan. You can cook the pre-roasted/seared meat with the "low temperature cooking" function for a long time. Cook with one tray only.
Upper section 	Fan heating Economic fan Top heater+fan Full grill+Fan Full grill Defrost Economic grill	Single large section 
Lower section 	Fan heating Economic fan Defrost Bottom heating Pizza	
Lower-upper section 	Fan assisted+Fan assisted Full grill+Fan assisted Defrost+Defrost Economic grill+Fan assisted Fan assisted+Bottom heater Fan assisted+Pizza	
		Static Static+fan Fan heating Multi cooking (3D) Pizza Top heater+fan Full grill+Fan Full grill Economic grill Economic fan Bottom heating Warm keeping Low temperature cooking Defrost

Function table

Function table indicates the functions that can be used in the oven and their respective maximum and minimum temperatures. Recommended temperature is displayed when the function is selected.

- i** Functions vary depending on the product model.
- i** While making any adjustment, related symbols will flash on the display.
- i** Program will be cancelled in case of power failure. You must reprogram the oven.
- i** Current time cannot be set while the oven is operating in any function, or if semi-automatic or full automatic programming is made on the oven.
- i** Even if the oven is switched off, oven lamp lights up when the oven door is opened.
- i** Due to safety reasons, maximum time that can be set for "Cooking time" is limited with 6 hours at all positions apart from "Warm Keeping" and "Low Temp. Cooking" functions.
- i** Due to safety reasons, maximum time that can be set for "Cooking time" is limited with 6 hours at all positions apart from "Warm Keeping" and "Low Temp. Cooking" functions.

Single large section

Function	Temperature range (°C)
Static	40-280
Static + fan	40-280
Fan heating	40-250
Multi cooking (3D)	40-250
Pizza	40-280
Top heater+fan	40-280
Full grill+Fan	40-280
Full grill	40-280
Economic grill	40-280
Economic fan	160-220
Bottom heating	40-220
Warm keeping	40-100
Low temperature cooking	50-150
Defrost	-

Upper section

Function	Temperature range (°C)
Fan heating	40-250
Top heater+fan	40-280
Full grill+Fan	40-280
Full grill	40-280
Economic grill	40-280
Economic fan	160-220
Defrost	-

Lower section

Function	Temperature range (°C)
Fan heating	40-250
Pizza	40-280
Economic fan	160-220
Bottom heating	40-220
Defrost	-

How to operate the oven control unit

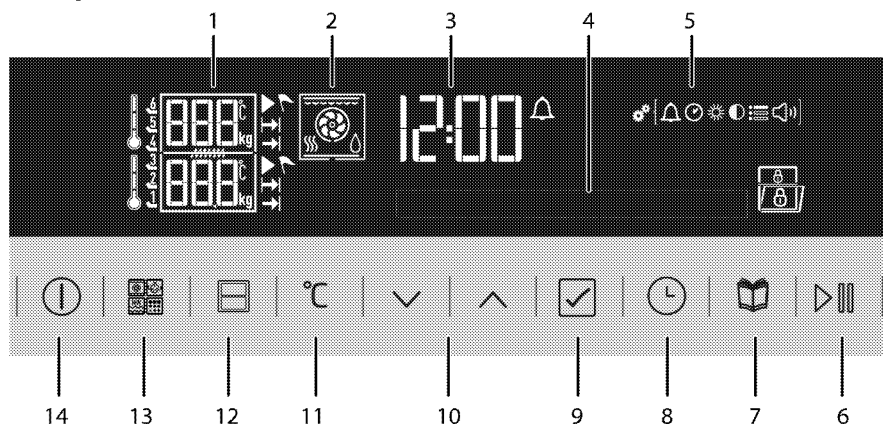

- 1 Temperature/weight indicator field
- 2 Function display
- 3 Current time indicator field
- 4 Text display
- 5 Settings menu symbols
- 6 Start/stop cooking key
- 7 Convenience food menu selection key
- 8 Time and settings key
- 9 Confirmation key
- 10 Up/down keys (Menu step) (Menu selection)
- 11 Temperature/weight/booster setting key
- 12 Oven section selection key
- 13 Function selection key *
- 14 ON/OFF key

* Present in ovens with self-cleaning, steamer and microwave properties.

Display symbols:

- Rapid heating (Booster) symbol
- Cooking time symbol
- End of cooking time symbol*
- Alarm symbol
- Stand-by symbol
- Cooking symbol
- Current time symbol
- Settings symbol
- Warm keeping symbol

- Defrost symbol
- Key lock symbol
- Door open symbol
- Brightness setting symbol
- Volume setting symbol
- Language setting symbol
- Meat probe symbol *
- * Varies depending on the product model.

Operating the oven as a single section

Manual operation

During manual operation, the oven will operate independent of the cooking time after the function and temperature selection is made. The oven will not turn off automatically at the end of cooking time. It should be ended by the user. Oven returns to stand-by display after it is powered on for the first time and the current time is set. Only the current time appears on the display.

1. **Remove the middle section plate from the oven. Only after the middle section plate is removed the oven timer will work in single large section cooking setting.**
2. Turn on the oven touching the key for two seconds.

3. When the oven is first turned on, the single large section cooking function will be displayed.



4. Set the desired cooking function touching the \wedge / \vee keys.

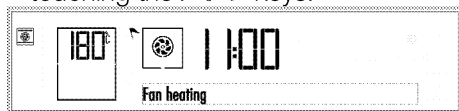

5. If you want to change the temperature, touch $^{\circ}\text{C}$ once to reach the temperature display. $^{\circ}\text{C}$ symbol flashes on the display and "Temperature" text will be displayed.

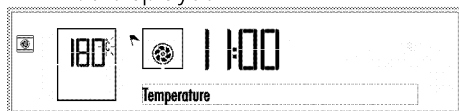

6. Set the desired temperature touching \wedge / \vee keys. When the desired value is reached, confirm the temperature by touching \checkmark key.

7. For Booster setting, press $^{\circ}\text{C}$ button twice to activate booster setting.

"Booster passive" warning and \equiv symbol appear on the display.

8. Press any of \vee or \wedge keys to activate the booster setting. "Booster active" warning and \equiv symbol appear on the display. Confirm the setting by touching \checkmark .

- i** When the booster setting is made, the oven operates in maximum power to reach the set temperature. When the set temperature is reached \equiv symbol will disappear. Booster setting is active for the functions during which \equiv is displayed when the $^{\circ}\text{C}$ button is touched twice.

9. Put your dish into the oven and close the door.

10. If cooking function and temperature values are suitable, touch \triangleright key for two seconds to start cooking. Cooking starts and "Cooking" appears on the display.



- » Oven heats up to the adjusted temperature.

- i** All segments of the inner oven temperature symbol \downarrow will turn on when the oven reaches the set temperature.

- i** If the oven door is opened, "Door open" warning and/or \square symbol appears on the display.

11. When the cooking process is completed touch \triangleright key again for two seconds to end the cooking.

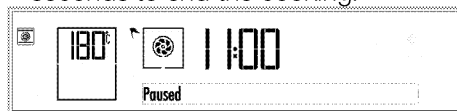

Semi-automatic operation

Oven returns to stand-by display after it is powered on for the first time and the current time is set. Only the current time appears on the display.

In semi-automatic operation, you may adjust the time period during which the oven will operate (cooking time).

- 1. Remove the middle section plate from the oven. Only after the middle section plate is removed the oven timer will work in single large section cooking setting.**
2. Turn on the oven touching the Ⓢ key for two seconds.

3. When the oven is first turned on, the single large section cooking function will be displayed.



4. Set the desired cooking function touching the \wedge/\vee keys.

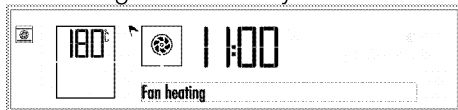

5. If you want to change the temperature, touch $^{\circ}\text{C}$ once to reach the temperature display. $^{\circ}\text{C}$ symbol flashes on the display and "Temperature" text will be displayed.

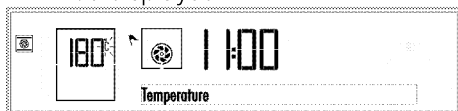

6. Set the desired temperature touching \wedge/\vee keys. When the desired value is reached, confirm the temperature by touching \checkmark key.

7. For Booster setting, press $^{\circ}\text{C}$ button twice to activate booster setting.

"Booster passive" warning and \equiv symbol appear on the display.

8. Press any of \vee or \wedge keys to activate the booster setting. "Booster active" warning and \equiv symbol appear on the display. Confirm the setting by touching \checkmark .

i When the booster setting is made, the oven operates in maximum power to reach the set temperature. When the set temperature is reached \equiv symbol will disappear. Booster setting is active for the functions during which \equiv is displayed when the $^{\circ}\text{C}$ button is touched twice.

9. For cooking time, press ⌚ key for once to scroll to the "Cook time" on the text display. \rightarrow symbol flashes at the same time.

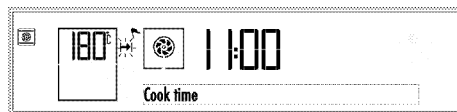

10. Touch \wedge/\vee keys to set the desired cooking time and confirm the setting by touching the \checkmark key. Once the Cooking Time is set, \rightarrow symbol will be displayed continuously.

11. Put your dish into the oven and close the door.

12. If cooking function, temperature and time values are suitable, touch \triangleright key for 2 seconds to start cooking. Cooking starts and "Cooking" appears on the display.

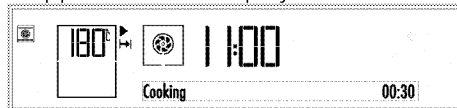

» The oven will be heated up to the set temperature and will maintain this temperature until the end of the cooking time you selected.

i All segments of the inner oven temperature symbol \downarrow will turn on when the oven reaches the set temperature.

i If the oven door is opened, "Door open" warning and/or \square symbol appears on the display.

13. After the cooking is completed, "Enjoy your meal" and "Press start to continue" texts appear on the display and alarm signal is heard.

14. To stop the alarm signal, just touch any key. The oven is switched off automatically.

15. If you want the oven to continue operating, press \triangleright key for 2 seconds.

The oven will continue cooking for an indefinite period of time.

- i** If you want to cancel the semi-automatic programming after you have set it, you need to reset the cooking time. You can also switch off the oven by touching the  key if you want.

Full-automatic operation (This feature is optional. It may not exist on your product.)

In full-automatic operation mode, you can adjust cooking time and end of cooking time.

Oven returns to stand-by display after it is powered on for the first time and the current time is set. Only the current time appears on the display.

1. **Remove the middle section plate from the oven. Only after the middle section plate is removed the oven timer will work in single large section cooking setting.**
2. Turn on the oven touching the  key for two seconds.
3. When the oven is first turned on, the single large section cooking function will be displayed.

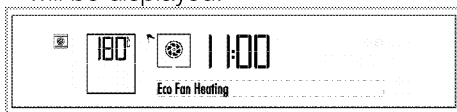



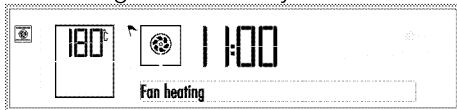



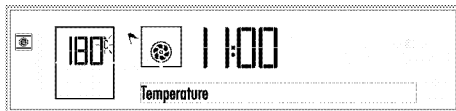

4. Set the desired cooking function touching the  keys.





5. If you want to change the temperature, touch $^{\circ}\text{C}$ once to reach the temperature display. $^{\circ}\text{C}$ symbol flashes on the display and "Temperature" text will be displayed.







6. Set the desired temperature touching  keys. When the desired value is reached, confirm the temperature by touching  key.
7. For Booster setting, press $^{\circ}\text{C}$ button twice to activate booster setting. "Booster passive" warning and  symbol appear on the display.
8. press any of  or  keys to activate the booster setting. "Booster active" warning and  symbol appear on the display. Confirm the setting by touching .

- i** When the booster setting is made, the oven operates in maximum power to reach the set temperature. When the set temperature is reached  symbol will disappear. Booster setting is active for the functions during which  is displayed when the $^{\circ}\text{C}$ button is touched twice.

9. For cooking time, press  key for once to scroll to the "Cook time" on the text display.  symbol flashes at the same time.



10. Touch  keys to set the desired cooking time and confirm the setting by touching the  key. Once the Cooking Time is set,  symbol will be displayed continuously.
11. For the end of cooking time, touch  with short intervals until "Cook end time" appears on the text display.  symbol flashes at the same time.

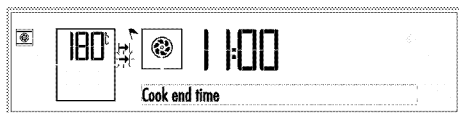

12. Touch keys to set the desired end of cooking time and confirm the setting by touching the key. Once the Cook end time is set, will be displayed continuously.
13. Put your dish into the oven and close the door.
14. If cooking function, temperature, time and end of cooking time values are suitable, touch key for 2 seconds to start cooking.
» » **“Stand by”** message will appear on the display. Oven timer automatically calculates the startup time for cooking by deducting the cooking time from the end of cooking time you have set.
15. Selected operation mode is activated when the startup time of cooking has come, **“Cooking”** appears on the display and the oven is heated up to the set temperature. It maintains this temperature until the end of the cooking time. The oven lamp is lit for a certain time during the cooking process.

All segments of the inner oven temperature symbol will turn on when the oven reaches the set temperature.

If the oven door is opened, **“Door open”** warning and/or symbol appears on the display.

16. After the cooking is completed, **“Enjoy your meal”** and **“Press start to continue”** texts appear on the display and alarm signal is heard.
17. To stop the alarm signal, just touch any key. The oven is switched off automatically.

18. If you want the oven to continue operating, press key for 2 seconds. The oven will continue cooking for an indefinite period of time.

If you want to cancel the full-automatic programming after you have set it, you need to reset the cooking time. You can also switch off the oven by touching the key if you want.

Using the oven only as the top or bottom section

Manual operation

During manual operation, the oven will operate independent of the cooking time after the function and temperature selection is made. The oven will not turn off automatically at the end of cooking time. It should be ended by the user. Oven returns to stand-by display after it is powered on for the first time and the current time is set. Only the current time appears on the display.

1. Place the middle section plate in its housing found between the 3rd and 4th rack guides.

If the middle section plate is not placed in position, the oven will operate as a whole single section.

2. Turn on the oven touching the key for two seconds.
3. When the oven is first turned on, the top section cooking function will be displayed.



4. Touch once to activate the bottom section of oven. symbol will appear next to the active oven section. Temperature setting and cooking process initiation steps for both bottom and top oven sections will iterate

in the same way. (In the images, the bottom oven is shown as selected.)

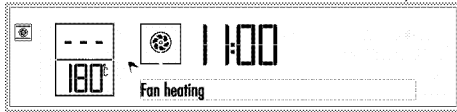

- Each time you touch the key is, bottom section only, both bottom and top sections and top section only will be activated respectively.

5. Set the desired cooking function touching the keys.

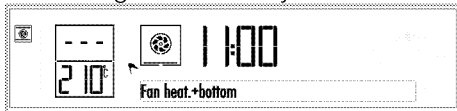

6. If you want to change the temperature, touch $^{\circ}\text{C}$ once to reach the temperature display. $^{\circ}\text{C}$ symbol flashes on the display and "Temperature" text will be displayed.

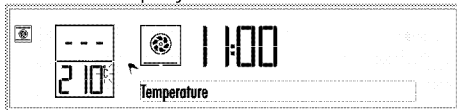

7. Set the desired temperature touching keys. When the desired value is reached, confirm the temperature by touching key.

8. Put your dish into the oven and close the door.

9. If cooking function and temperature values are suitable, touch key for two seconds to start cooking. Cooking starts and "Cooking" appears on the display.

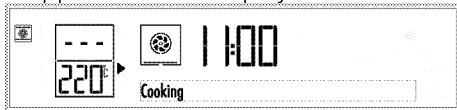

» Oven heats up to the adjusted temperature.

- All segments of the inner oven temperature symbol will turn on when the oven reaches the set temperature.

- If the oven door is opened, "Door open" warning and/or symbol appears on the display.

10. When the cooking process is completed touch key again for two seconds to end the cooking.



- When using only the top or bottom section for cooking, keep the unused section empty as it will get hot.

Semi-automatic operation

In semi-automatic operation, you may adjust the time period during which the oven will operate (cooking time).

Oven returns to stand-by display after it is powered on for the first time and the current time is set. Only the current time appears on the display.

1. Place the middle section plate in its housing found between the 3rd and 4th rack guides.

- If the middle section plate is not placed in position, the oven will operate as a whole single section.

2. Turn on the oven touching the key for two seconds.

3. When the oven is first turned on, the top section cooking function will be displayed.

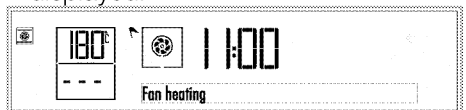

4. Touch once to activate the bottom section of oven.

↖ symbol will appear next to the active oven section. Temperature setting and cooking process initiation steps for both bottom and top oven sections will iterate in the same way. (In the images, the bottom oven is shown as selected.)

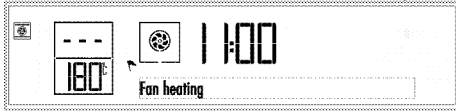



i Each time you touch the  key is, bottom section only, both bottom and top sections and top section only will be activated respectively.

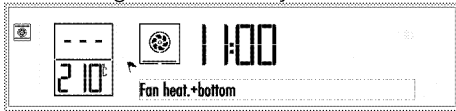

5. Set the desired cooking function touching the  keys.

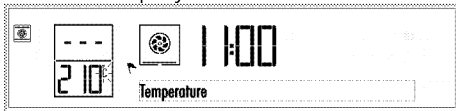





6. If you want to change the temperature, touch °C once to reach the temperature display. °C symbol flashes on the display and "Temperature" text will be displayed.



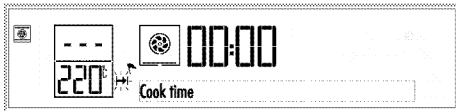

7. Set the desired temperature touching  keys. When the desired value is reached, confirm the temperature by touching  key.

8. For cooking time, press  key for once to scroll to the "Cook time" on the text display.  symbol flashes at the same time.



9. Touch  keys to set the desired cooking time and confirm the setting by touching the  key. Once the Cooking Time is set,  symbol will be displayed continuously.

10. Put your dish into the oven and close the door.

11. If cooking function and temperature values are suitable, touch  key for two seconds to start cooking. Cooking starts and "Cooking" appears on the display. ↖ symbols disappear while  symbols appear on the display.



» The oven will be heated up to the set temperature and will maintain this temperature until the end of the cooking time you selected.

i All segments of the inner oven temperature symbol  will turn on when the oven reaches the set temperature.

i If the oven door is opened, "Door open" warning and/or  symbol appears on the display.

12. After the cooking is completed, "Enjoy your meal" and "Press start to continue" texts appear on the display and alarm signal is heard.

13. To stop the alarm signal, just touch any key. The oven is switched off automatically.

14. If you want the oven to continue operating, press  key for 2 seconds. The oven will continue cooking for an indefinite period of time.

i When using only the top or bottom section for cooking, keep the unused section empty as it will get hot.

- i** If you want to cancel the semi-automatic programming after you have set it, you need to reset the cooking time. You can also switch off the oven by touching the  key if you want.

Full-automatic operation (This feature is optional. It may not exist on your product.)

In full-automatic operation mode, you can adjust cooking time and end of cooking time.

Oven returns to stand-by display after it is powered on for the first time and the current time is set. Only the current time appears on the display.

1. Place the middle section plate in its housing found between the 3rd and 4th rack guides.

- i** If the middle section plate is not placed in position, the oven will operate as a whole single section.

2. Turn on the oven touching the  key for two seconds.
3. When the oven is first turned on, the top section cooking function will be displayed..

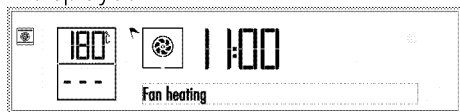

4. Touch  once to activate the bottom section of oven.

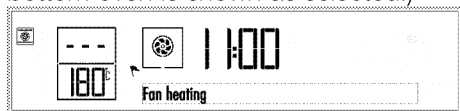

 symbol will appear next to the active oven section. Temperature setting and cooking process initiation steps for both bottom and top oven sections will iterate in the same way. (In the images, the bottom oven is shown as selected.)





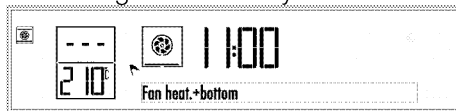

- i** Each time you touch the  key is, bottom section only, both bottom and top sections and top section only will be activated respectively.

5. Set the desired cooking function touching the  keys.







6. If you want to change the temperature, touch  once to reach the temperature display.  symbol flashes on the display and "Temperature" text will be displayed.



7. Set the desired temperature touching  keys. When the desired value is reached, confirm the temperature by touching  key.
8. For cooking time, press  key for once to scroll to the "Cook time" on the text display.  symbol flashes at the same time.



9. Touch  keys to set the desired cooking time and confirm the setting by touching the  key. Once the Cooking Time is set,  symbol will be displayed continuously.
10. For the end of cooking time, touch  with short intervals until "Cook end" appears on the text display.  flashes at the same time.

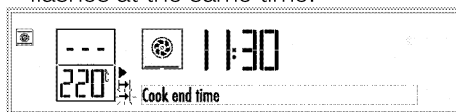

11. Touch  keys to set the desired end of cooking time and confirm the setting by touching the  key. Once the

Cook end time is set, →| will be displayed continuously.

12. Put your dish into the oven and close the door.

13. If cooking function, temperature, time and end of cooking time values are suitable, touch ▷||| key for 2 seconds to start cooking.

» » **“Stand by”** message will appear on the display. Oven timer automatically calculates the startup time for cooking by deducting the cooking time from the end of cooking time you have set.

14. Selected operation mode is activated when the startup time of cooking has come, **“Cooking”** appears on the display and the oven is heated up to the set temperature. It maintains this temperature until the end of the cooking time. The oven lamp is lit for a certain time during the cooking process.

i All segments of the inner oven temperature symbol ↓ will turn on when the oven reaches the set temperature.

i If the oven door is opened, **“Door open”** warning and/or  symbol appears on the display.

15. After the cooking is completed, **“Enjoy your meal”** and **“Press start to continue”** texts appear on the display and alarm signal is heard.

16. To stop the alarm signal, just touch any key. The oven is switched off automatically.

17. If you want the oven to continue operating, press ▷||| key for 2 seconds. The oven will continue cooking for an indefinite period of time.

i When using only the top or bottom section for cooking, keep the unused section empty as it will get hot.

i If you want to cancel the full-automatic programming after you have set it, you need to reset the cooking time. You can also switch off the oven by touching the  key if you want.

Using the top and bottom sections of the oven simultaneously

Manual operation

During manual operation, the oven will operate independent of the cooking time after the function and temperature selection is made. The oven will not turn off automatically at the end of cooking time. It should be ended by the user. Oven returns to stand-by display after it is powered on for the first time and the current time is set. Only the current time appears on the display.

1. **Place the middle section plate in its housing found between the 3rd and 4th rack guides.**



i If the middle section plate is not placed in position, the oven will operate as a whole single section.

2. Turn on the oven touching the  key for two seconds.

3. When the oven is first turned on, the top section cooking function will be displayed.



i Each time you touch the  key, bottom section only, both bottom and top sections and top section only will be activated respectively.

4. Activate both sections by touching  key twice.  symbol will appear next to each oven section.

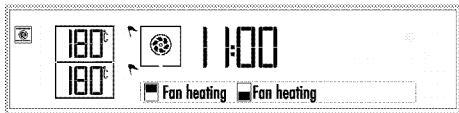



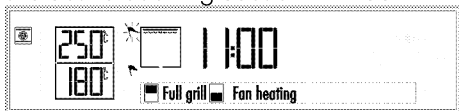

5. Touch the  keys to select the appropriate cooking function amongst the ones adjusted for both oven sections. For example, to make grill in the top and cook pastry in the bottom section you can select Grill & Fan supported function.

After the function is selected, **"Temperature"** and **"Cook time"** can be adjusted separately for each oven section. For these settings  symbol of the active cooking section will flash.

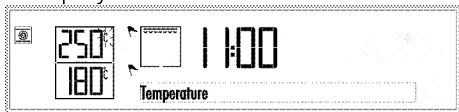

6. If you want to change the temperature of top oven, touch $^{\circ}\text{C}$ key once to access the temperature display of top oven. In the temperature display of the selected oven section $^{\circ}\text{C}$ symbol will flash and **"Temperature"** text will be displayed.



7. Set the desired temperature touching  keys. When you reach the desired value, confirm the temperature by touching . $^{\circ}\text{C}$ symbol will lid steadily and  symbol of the active cooking section will flash.

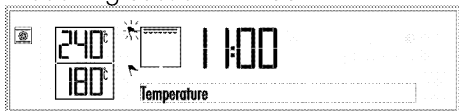





8. To change the temperature of the bottom oven, activate the bottom oven's temperature display touching

the  key. Bottom oven's  symbol will flash.

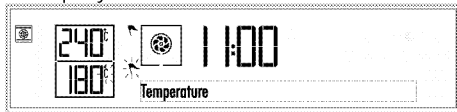



9. Touch $^{\circ}\text{C}$ once to access the temperature display of bottom oven. In the temperature display of the selected oven section $^{\circ}\text{C}$ symbol will flash and **"Temperature"** text will be displayed.



10. Set the desired temperature touching  keys. When you reach the desired value, confirm the temperature by touching . $^{\circ}\text{C}$ symbol will lid steadily and  symbol of the active cooking section will flash.

i While using the top and bottom sections simultaneously, if you want to change temperature setting, the difference between the sections cannot be more than 80 $^{\circ}\text{C}$. Because the sections will be affected from each others temperature.

11. Put your dish into the oven and close the door.

12. If cooking function and temperature values are suitable, touch  key for two seconds to start cooking. Cooking starts and **"Cooking"** appears on the display.  symbols disappear while  symbols appear on the display.



i All segments of the inner oven temperature symbol  will turn on when the oven reaches the set temperature.

i If the oven door is opened, "Door open" warning and  symbol appears on the display.

13. When the cooking process is completed touch  key again for two seconds to end the cooking.

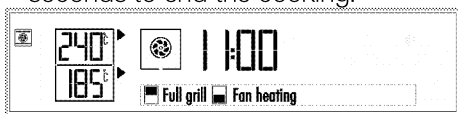

Semi-automatic operation

In semi-automatic operation, you may adjust the time period during which the oven will operate (cooking time). Oven returns to stand-by display after it is powered on for the first time and the current time is set. Only the current time appears on the display.

1. Place the middle section plate in its housing found between the 3rd and 4th rack guides.



i If the middle section plate is not placed in position, the oven will operate as a whole single section.

2. Turn on the oven touching the  key for two seconds.

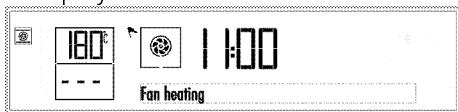

3. When the oven is first turned on, the top section cooking function will be displayed.



i Each time you touch the  key is, bottom section only, both bottom and top sections and top section only will be activated respectively.

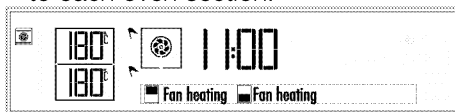

4. Activate both sections by touching  key twice.  symbol will appear next to each oven section.







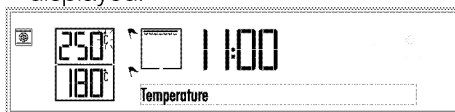

5. Touch the   keys to select the appropriate cooking function amongst the ones adjusted for both oven sections. For example, to make grill in the top and cook pastry in the bottom section you can select Grill & Fan supported function.

After the function is selected, "Temperature" and "Cook time" can be adjusted separately for each oven section. For these settings  symbol of the active cooking section will flash.



6. If you want to change the temperature of top oven, touch  key once to access the temperature display of top oven. In the temperature display of the selected oven section  symbol will flash and "Temperature" text will be displayed.



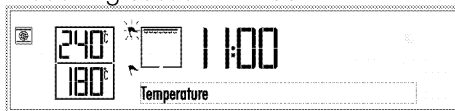

7. Set the desired temperature touching   keys. When you reach the desired value, confirm the temperature by touching .  symbol will lid steadily and  symbol of the active cooking section will flash.







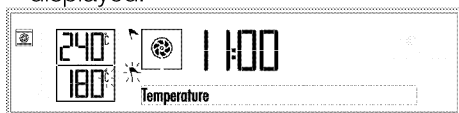

8. To change the temperature of the bottom oven, activate the bottom oven's temperature display touching

the  key. Bottom oven's  symbol will flash.





9. Touch  once to access the temperature display of bottom oven. In the temperature display of the selected oven section  symbol will flash and "Temperature" text will be displayed.













10. Set the desired temperature touching   keys. When you reach the desired value, confirm the temperature by touching .  symbol will lid steadily and  symbol of the active cooking section will flash.









 While using the top and bottom sections simultaneously, if you want to change temperature setting, the difference between the sections cannot be more than 80 °C. Because the sections will be affected from each others temperature.

11. For cooking time of the activated bottom section of the oven, touch  key for once to scroll to the "Cook time" on the text display. At the same time,   symbols will flash.



12. Touch   keys to set the desired cooking time and confirm the setting by touching the  key. Once the cooking time is set,   symbols will be displayed on the screen continuously.
13. For cooking time of the other top section, first activate the section



touching .  symbol of the top section flashes. Then, touch  key for once to scroll to the "Cook time" on the text display. At the same time,   symbols will flash.



14. Set the desired cooking time for the top section touching the   keys and confirm with  key. Once the cooking time of the top section is set,   symbols will be displayed on the screen continuously.
15. Put your dish into the oven and close the door.
16. If cooking function, temperature and time values are suitable, touch  key for 2 seconds to start cooking. Cooking starts and  symbols disappear while  symbols appear on the display.

The cooking time set will be shown at the end of the text screen. Here you can follow the remaining cooking time.



» The oven will be heated up to the set temperature and will maintain this temperature until the end of the short cooking time.

 All segments of the inner oven temperature symbol  will turn on when the oven reaches the set temperature.

 If the oven door is opened, "Door open" warning and/or  symbol appears on the display.



17. At the end of the short cooking time, "Enjoy your meal" and "Press start to continue" texts appear respectively on the display and alarm signal is heard.
18. Take the meal out of the oven when cooking time is over. When you close

the oven door again, cooking in the other section with longer cooking time will continue.

19. After the long cooking process is completed, **"Enjoy your meal"** and **"Press start to continue"** texts appear on the display respectively and alarm signal is heard.

20. To stop the alarm signal, just touch any key. The oven is switched off automatically.

21. If you want the oven to continue operating, press  key for 2 seconds. The oven will continue cooking for an indefinite period of time.

 If you want to cancel the semi-automatic programming after you have set it, you need to reset the cooking time. You can also switch off the oven by touching the  key for 2 seconds if you want.

Switching off the electric oven

Touch  key for 2 seconds to turn off the oven.

Using the keylock

You can prevent oven from being intervened with by activating the key lock function.



 Key lock can be used when the oven is in stand-by.

Activating the keylock

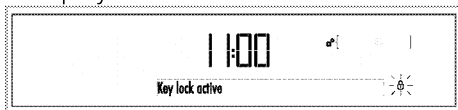
1. Touch  key with short intervals until **"Keylock passive"** appears on the display.





»  symbol flashes.

2. Activate the key lock touching any of the  symbols once. The key lock will be activated, **"Key lock active"** will appear on the display.  symbol continues to flash.

3. Touch  to confirm the setting.

» The text disappears and  symbol flashes continuously.

 Except for  keys, other oven keys are not functional when the keylock function is activated.

Deactivating the keylock

1. Deactivate the keylock touching any of the  symbols once. **"Key lock passive"** appears on the display.

2. Touch  to confirm the setting.

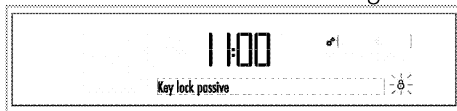

» Key lock is deactivated and the  symbol on the display disappears.

Using the clock as an alarm

You can use the timer of the product for any warning or reminder apart from the cooking program.



The alarm clock has no influence on the functions of the oven. It is only used as a warning. For example, this is useful when you want to turn food in the oven at a certain point of time. Alarm clock will give a signal once the time you set is over.

 Maximum alarm time can be 23 hours and 59 minutes.

To set the alarm:







1. Touch  key with short intervals until symbol appears on the display.  symbol starts to flash

2. Touch  keys to set the desired time and confirm the setting by touching the  key.  symbol remains lit after setting the alarm time.

3. Alarm will be given after the alarm time has elapsed.



4. Press any key to stop the alarm.

To cancel the alarm:



1. Touch  key with short intervals until  symbol appears on the display.
 2. Touch the  key until "00:00" appears on the display and confirm the setting by touching the  key.
- » Alarm is cancelled and  symbol disappears.

Brightness setting

Brightness can only be set when the oven is on stand-by display.

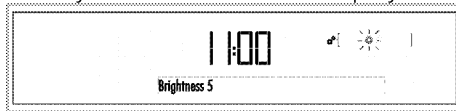
1. Touch  key with short intervals until "Brightness" appears on the display.  symbol flashes on the display.





2. There are 5 brightness levels, namely 1, 2, 3, 4 and 5. Touch  keys to select the desired level.
3. Touch  to confirm the setting.

 Brightness level decreases to save power when the oven is switched off. It restores to the set level again when the oven is switched on.

» It returns to the stand-by display. Only the current time appears on the display.

Voice Level setting

Volume level can only be set when the oven is on stand-by display.

1. Touch  key with short intervals until  symbol appears on the display. Symbol flashes on the display.

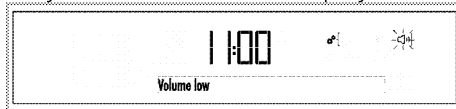



2. There are 2 volume levels, namely "Volume low" and "Volume high". Touch  keys to select the desired level.



3. Touch  to confirm the setting.
- » It returns to the stand-by display. Only the current time appears on the display.

Language setting

Language can only be set when the oven is on stand-by display.

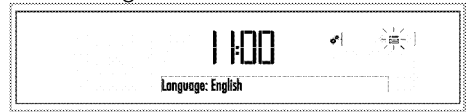

1. Touch  key until you see  symbol in settings menu.







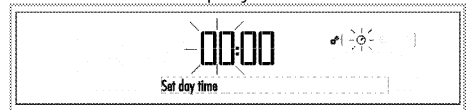

2.  symbol flashes on the display and set language option will be displayed.
 3. Touch  keys to select the desired language.
 4. Touch  to confirm the setting.
- » It returns to the stand-by display. Only the current time appears on the display.

Current time setting

Current time can only be set when the oven is switched off. If you want to change the time that was set during initial setup:

1. Touch  key with short intervals until "Set current time" text appears on the display. Hour field and  symbol flash on the display.



2. Set the hour field with  keys.
3. Touch  to confirm the setting.
4. Minute field and  symbol flash. Set the minute with  keys. Touch  to confirm the minute.



» It returns to the stand-by display. Only the current time appears on the display.

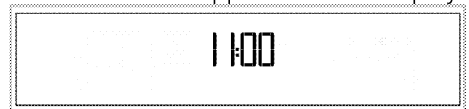





















Cooking times table













i The timings in this chart are meant as a guide. Timings may vary due to temperature of food, thickness, type and your own preference of cooking.

For single large section Baking and roasting

i When you open the oven door, if there are cooking tips available on the glass of the oven door these are applicable for the single whole section.

i 1st rack of the oven is the **bottom** rack.











Dish	Cooking level number	Accessory to use	Operating mode	Rack position	Temperature (°C)	Cooking time (approx. in min.)
Cakes in tray	One level	Standard tray*		3	175	25 ... 35
Cakes in mould	One level	Cake mold on wire grill**		2	180	40 ... 50
Small cakes	One level	Standard tray*		3	160	20 ... 30
	One level	Standard tray*		3	150	25 ... 35
	2 levels	1-Deep tray* 5-Standard tray*		1 - 5	150	25 ... 35
	3 levels	1-Deep tray* 3-Standard tray* 5-Pastry tray*		1 - 3 - 5	150	30 ... 45
Sponge cake	One level	Round springform pan with a diameter of 26 cm on wire grill**		3	160	25 ... 35
	One level	Round springform pan with a diameter of 26 cm on wire grill**		2	150	30 ... 40
	2 levels	1-Round springform pan with a diameter of 26 cm on wire grill** 4-Round springform pan with a diameter of 26 cm on pastry tray**		1 - 4	150	25 ... 35
Cookies	One level	Pastry tray*		3	175	25 ... 30
	2 levels	1-Pastry tray* 5-Standard tray*		1 - 5	170 ... 190	30 ... 40
	3 levels	1-Pastry tray* 3-Standard tray* 5-Deep tray*		1 - 3 - 5	175	35 ... 45
Dough pastry	One level	Standard tray*		2	200	30 ... 40
	2 levels	1-Pastry tray* 5-Standard tray*		1 - 5	200	45 ... 55
	3 levels	1-Pastry tray* 3-Standard tray* 5-Deep tray*		1 - 3 - 5	200	55 ... 65
Rich pastry	One level	Standard tray*		2	200	25 ... 35
	2 levels	1-Pastry tray* 5-Standard tray*		1 - 5	200	35 ... 45
	3 levels	1-Pastry tray* 3-Standard tray* 5-Deep tray*		1 - 3 - 5	190	45 ... 55
Leaven	One level	Standard tray*		2	200	35 ... 45
	2 levels	1-Standard tray* 3-Pastry tray*		1 - 3	190	35 ... 45

Dish	Cooking level number	Accessory to use	Operating mode	Rack position	Temperature (°C)	Cooking time (approx. in min.)
Lasagna	One level	Glass/metal rectangular pan on wire grill**		2 - 3	200	30 ... 40
Pizza	One level	Standard tray*		2	200 ... 220	15 ... 20
	One level	Standard tray*		3	200	10 ... 15
Beef steak (whole) / Roast	One level	Standard tray*		3	25 min. 250/max then 180 ... 190	100 ... 120
Leg of Lamb (casserole)	One level	Standard tray*		3	25 min. 250/max then 190	70 ... 90
	One level	Standard tray*		3	25 min. 250/max then 190	70 ... 90
Roasted chicken (1.8-2 kg)	One level	Standard tray*		2	15 min. 250/max then 180 ... 190	60 ... 80
	One level	Standard tray*		2	15 min. 250/max then 180 ... 190	60 ... 80
Turkey (5.5 kg)	One level	Standard tray*		1	25 min. 250/max then 180 ... 190	150 ... 210
	One level	Standard tray*		1	25 min. 250/max then 180 ... 190	150 ... 210
Fish	One level	Standard tray*		3	200	20 ... 30
	One level	Standard tray*		3	200	20 ... 30

It is suggested to perform preheating for all foods.
* These accessories may not be supplied with the product.
** These accessories are not supplied with the product. They are commercially available accessories.

For bottom section only Baking and roasting







i Foods given only in the bottom section cooking table and only in the top section cooking table can be cooked at the same time in 2 separate volumes. However, the temperature difference between the two sections cannot be adjusted greater than 80 °C.

Dish	Cooking level number	Accessory to use	Operating mode	Rack position	Temperature (°C)	Cooking time (approx. in min.)
Cakes in mould	One level	Cake mold on wire grill**		1	175	40 ... 50
Small cakes	One level	Standard tray*		2	150	35 ... 45
	2 levels	1-Deep tray* 3-Standard tray*		1 - 3	150	35 ... 45
Sponge cake	One level	Round springform pan with a diameter of 26 cm on wire grill**		1	150	25 ... 35
Cookies	One level	Pastry tray*		2	170 ... 180	35 ... 45
	2 levels	1-Pastry tray* 3-Standard tray*		1 - 3	165	35 ... 40
Rich pastry	One level	Standard tray*		2	190	35 ... 45
Pizza	One level	Standard tray*		1	200	10 ... 15
Roasted chicken (1.8-2 kg)	One level	Standard tray*		1	15 min. 250/max then 180 ... 190	60 ... 80
Turkey (Sliced)	One level	Standard tray*		1	25 min. 250/max then 180 ... 190	150 ... 210
Fish	One level	Standard tray*		2	200	20 ... 30

Dish	Cooking level number	Accessory to use	Operating mode	Rack position	Temperature (°C)	Cooking time (approx. in min.)
It is suggested to perform preheating for all foods.						
* These accessories may not be supplied with the product.						
** These accessories are not supplied with the product. They are commercially available accessories.						

For top section only Baking and roasting

i Foods given only in the bottom section cooking table and only in the top section cooking table can be cooked at the same time in 2 separate volumes. However, the temperature difference between the two section cannot be adjusted greater than 80 °C.

Dish	Cooking level number	Accessory to use	Operating mode	Rack position	Temperature (°C)	Cooking time (approx. in min.)
Cakes in mould	One level	Cake mold on wire grill**		4	175	40 ... 50
Small cakes	One level	Standard tray*		5	150	25 ... 40
Cookies	One level	Pastry tray*		4	170 ... 180	35 ... 45
Rich pastry	One level	Standard tray*		4	190	35 ... 45
Roasted chicken (1.8-2 kg)	One level	Standard tray*		4	15 min. 250/max then 180 ... 190	60 ... 80
Turkey (Sliced)	One level	Standard tray*		4	25 min. 250/max then 180 ... 190	150 ... 210
Fish	One level	Standard tray*		5	200	20 ... 30

It is suggested to perform preheating for all foods.

* These accessories may not be supplied with the product.

** These accessories are not supplied with the product. They are commercially available accessories.

Eco Fan Heating

i Do not change the cooking temperature after cooking starts in Eco Fan Heating mode.

i Do not open the door during cooking in the Eco Fan Heating mode.

Dish	Cooking level number	Accessory to use	Rack position	Temperature (°C)	Cooking time (approx. in min.)
Small cakes	One level	Standard tray*	3	160	25 ... 35
Cookies	One level	Standard tray*	3	200	30 ... 35
Dough pastry	One level	Standard tray*	3	200	40 ... 45
Rich pastry	One level	Standard tray*	3	200	40 ... 45















* These accessories may not be supplied with the product.

Cooking table for test meals (for single large section)

Meals in this cooking table are prepared according to EN 60350-1 to make it

easier for control institutes to test the product.

 1st rack of the oven is the **bottom** rack.

Dish	Cooking level number	Accessory to use	Operating mode	Rack position	Temperature (°C)	Cooking time (approx. in min.)
Shortbread	One level	Standard tray*		3	140	20 ... 30
	One level	Standard tray*		3	140	20 ... 30
	2 levels	1-Standard tray* 3-Pastry tray*		1 - 3	140	20 ... 30
	3 levels	1-Standard tray* 3-Pastry tray* 5-Deep tray*		1 - 3 - 5	140	25 ... 35
Small cakes	One level	Standard tray*		3	160	20 ... 30
	One level	Standard tray*		3	150	25 ... 35
	2 levels	1-Deep tray* 5-Standard tray*		1 - 5	150	25 ... 35
	3 levels	1-Deep tray* 3-Standard tray* 5-Pastry tray*		1 - 3 - 5	150	30 ... 45
Sponge cake	One level	Round springform pan with a diameter of 26 cm on wire grill**		3	160	25 ... 35
	One level	Round springform pan with a diameter of 26 cm on wire grill**		2	150	30 ... 40
	2 levels	1-Round springform pan with a diameter of 26 cm on wire grill** 4-Round springform pan with a diameter of 26 cm on pastry tray**		1 - 4	150	25 ... 35
Apple pie	One level	Round black metal dish with a diameter of 20 cm on wire grill**		2	180	55 ... 65
	One level	Round black metal dish with a diameter of 20 cm on wire grill**		3	180	50 ... 60
	2 levels	1-Round black metal dish with a diameter of 20 cm on wire grill** 3-Round black metal dish with a diameter of 20 cm on pastry tray**		1 - 3	180	55 ... 65

It is suggested to perform preheating for all foods.

* These accessories may not be supplied with the product.

** These accessories are not supplied with the product. They are commercially available accessories.

Tips for baking cake

- If the cake is too dry, increase the temperature some 10°C and decrease the cooking time.
- If the cake is wet, use less liquid or lower the temperature by 10°C.
- If the cake is too dark on top, place it on a lower rack, lower the temperature and increase the cooking time.
- If cooked well on the inside but sticky on the outside use less liquid, lower the temperature and increase the cooking time.

Tips for baking pastry

- If the pastry is too dry, increase the temperature some 10°C and decrease the cooking time. Dampen the layers of dough with a sauce composed of milk, oil, egg and yoghurt.
- If the pastry takes too long to bake, pay care that the thickness of the pastry you have prepared does not exceed the depth of the tray.
- If the upper side of the pastry gets browned, but the lower part is not cooked, make sure that the amount of sauce you have used for the pastry is not too much at the bottom of the pastry. Try to scatter the sauce equally between the dough layers and on the top of pastry for an even browning.

i Cook the pastry in accordance with the mode and temperature given in the cooking table. If the bottom part is still not browned enough, place it on one lower rack next time.

Tips for cooking vegetables

- If the vegetable dish runs out of juice and gets too dry, cook it in a pan with a lid instead of a tray. Closed vessels will preserve the juice of the dish.
- If a vegetable dish does not get cooked, boil the vegetables beforehand or prepare them like canned food and put in the oven.

Ready meals functions

Selecting the ready meals functions

Ready Meals menu contains meal programmes that are specially prepared for you by professional cooks specially and stored in the memory of the control unit.

In this menu, temperature, rack position, weight and cooking functions are set automatically.

You can change the weight and cooking time according to your meal and your taste. Ready meals menus are present at combinations of single large section, bottom section and lower-upper section.

To select the ready meal functions:

1. Touch **i** key to switch on the oven. If the middle section plate is inserted, when the oven is turned on the top section cooking function will be displayed.

i Each time you touch the **☐** key is, bottom section only, both bottom and top sections and top section only will be activated respectively. Ready meals menus are present at combinations of single large section, bottom section and lower-upper section.

2. Touch **☐** key to select the section in which you will cook.
3. Touch **🍪** key to select the Ready Meals function display. Main menu will be displayed on the text screen at this stage.



4. Touch **↖↗** keys to select the desired Ready Meals function main menu.
5. Touch the **☑** key to confirm the Main Meal menu you have selected.
6. Touch **↖↗** keys to select the desired meal (Cookies, Cake, Small cake, etc).



7. Before starting to cook in the Ready Meals menu, you can set the weight depending on the meal type you have selected. To do this:

Touch °C until **"Weight"** appears on the display. In the weight display of the selected oven section **"kg"** symbol will flash and the **"Weight"** will appear.

8. Select the appropriate weight for your dish touching \wedge/\vee keys. When the desired value is reached, approve the temperature by touching \square key. **"kg"** symbol is lit continuously.

i Oven will change the temperature and the cooking time automatically on basis of the weight change.

i You can only change the weight for meals for which a weight is indicated.

9. Put your dish into the oven.
10. Touch \triangleright key to start cooking.

"Cooking" appears on the display.
» After the cooking is completed, **"Good appetite..."** appears on the display and alarm signal is heard. To stop the alarm signal, just press any key.

i "Back" command appearing on the display while navigating in the meal menu allows you to return to the upper menu. You may return to the first function screen pressing \square .

Ready Meals menu:

May vary depending on the models

For bottom section:

Cakes and pastry	Red meat	Fish	Meat poultry	Light meals	Special	Desserts	Dried Food	Frozen Foods
Walnut cookies	Stuffed Leg of Lamb	Trout	Chicken Small 1600 gr	Stuffed Peppers	Making Yoghurt	Fruit Pie	Dried apple	Frozen vegetable au gratin
Biscuits	Roast lamb	Sea Bass	Chicken, Large 1600 gr	Macaroni and cheese	Pastry leavening	Apple pie	Dried Quince	
Raisin Pie	Veal pot roast	Fish with Vegetables in Curpaper	Chopped chicken	Potato Crusted		Apple strudel	Dried Pear	
Vol au vent	Lamb in tandori	Steamed anchovies	Chicken Fillet	Vegetable quiche		Meringue		
Tea Bread	Steak	Trout on Tile	Chicken baguette	Mousaka		Éclair		
Baguette	Dalyan meatballs	Sea Bass Fillet	Turkey, thigh	Potatoes au gratin		Crème Caramel		
Bread	Baked Meatballs	Fish on Shish	Turkey Fillet	Baked Potatoes		Hot Chocolate Soufflé		
Loaf bread (yeasted)	Roast beef	Trout casserole	Duck	Casserole		Crème Brûlée		
Croissant	Beef Sirloin	Salmon fillet	Goose	Potato quiche		Honeyed Apple in Syrup		
Easter Cake		Salted Salmon	Pheasant, hunter style	Lasagna		Semolina Cake in Syrup		
Cinnamon rolls			Pheasant	Fresh vegetables au gratin				
Bun with Cheese Filling			Rabbit					
Bagel								
Pizza								

For single large section:

Cakes and pastry	Red meat	Fish	Meat poultry	Light meals	Special	Desserts	Dried Food	Frozen Foods
Walnut cookies	Stuffed Leg of Lamb	Trout	Chicken Small 1600 gr	Stuffed Peppers	Making Yoghurt	Fruit Pie	Dried apple	Frozen vegetable au gratin
Phyllo Pastry with Cheese	Roast lamb	Sea Bass	Chicken, Large 1600 gr	Macaroni and cheese	Pastry leavening	Apple pie	Dried Quince	Frozen Pizza
Biscuits	Veal pot roast	Fish with Vegetables in Curlpaper	Chopped chicken	Potato Crusted		Apple strudel	Dried Pear	Bread rolls, frozen
Raisin Pie	Lamb in tandori	Steamed anchovies	Chicken Fillet	Vegetable quiche		Meringue		
Vol au vent	Steak	Trout on Tile	Chicken baguette	Mousaka		Éclair		
Tea Bread	Dalyan meatballs	Sea Bass Fillet	Roast Turkey	Potatoes au gratin		Baked Rice Pudding		
Baguette	Baked Meatballs	Fish on Shish	Turkey, thigh	Baked Potatoes		Crème Caramel		
Bread	Roast Beef	Trout casserole	Turkey Fillet	Casserole		Hot Chocolate Soufflé		
Loaf bread (yeasted)	Beef Sirloin	Salmon fillet	Duck	Potato quiche		Crème Brûlée		
Croissant		Salted Salmon	Goose	Classic lasagna		Honeyed Apple in Syrup		
Easter Cake			Pheasant, hunter style	Fresh vegetables au gratin		Chocolate Cake		
Cinnamon rolls			Pheasant			Cocoa Cake		
Bun with Cheese Filling			Rabbit			Sponge Cake Dough		
Bagel						Soft Pastry in Syrup		
Pizza						Semolina Cake in Syrup		

Lower-upper section: Double convenience food

Upper section	Lower section
Classic lasagna	Pizza
Crème Brûlée	Meatballs with vegetables
Vegetable soup	Beef wellington
Vegetables au gratin	Sirloin steak
Lamb stew	Tahini cheesecake
Haricot beans	Lemon cake
Sea bass in salt	Corn bread

Upper section	Lower section
Leg of lamb tandori	Perde rice
Brownie cheesecake	Vegetarian quiche
Chicken baguette	Spinach flan

Recipes for convenience food menus

PIZZA

INGREDIENTS

For the dough:

- 400 g flour
- 15 g salt
- 3 g fresh yeast
- 20 g olive oil
- 250 g tepid water
-

For the sauce:

- 2 tomatoes, grated
- Half tablespoon tomato paste
- 1 teaspoon sugar
- 1 teaspoon salt
- 1 tablespoon olive oil

For the toppings:

- 150 g grated mozzarella or cheddar cheese
- Salami, fermented sausages, corn, olives, mushrooms on your discretion

PREPARATION

- Mix the yeast in water to dissolve completely.
- Knead half of the flour with yeast and water mixture.
- Continue kneading while adding salt and olive oil.
- After adding the rest of the flour, knead until you obtain a soft dough.
- Transfer the dough into a greased pot and cover it with plastic wrap. Leave the dough for fermentation for 1 night at room temperature.
- Take the fermented dough on the counter and knead. Cover the dough with a pot and rest it for another 30 minutes.
- Take the rested dough on standard baking tray covered with grease-proof paper and roll it out with your hand.
- Mix all ingredients of the sauce in a pot, and smear over the dough you placed on the baking tray.

- Add grated mozzarella and the toppings of your choice.
- At the end, you may add a little bit of olive oil on the toppings.
- Cook your dish on the pre-heated 1st rack of your oven.
- Serve hot.

LASAGNA

INGREDIENTS

For the Bolognese sauce:

- 200 g low-fat ground beef
- 1 mid-size onion, chopped
- 1 mid-size carrot, grated
- ½ mid-size celery root, grated
- 2 tomatoes, grated
- 1 tablespoon tomato paste
- 1 tablespoon olive oil
- 20 g butter
- ½ glass red wine
- 1 bay leaf
- Salt
- Black pepper
- ½ nutmeg, grated

For the Bechamel sauce:

- 2 glasses milk
- 2 tablespoons olive oil
- 40 g butter
- ½ pack dry lasagna macaroni
- 200 g powder parmesan

PREPARATION

Preparation of the Bolognese sauce:

- Fry the vegetables except tomatoes in olive oil and butter for 5 minutes.
- Add ground beef on the vegetables and fry for another 5 minutes.
- Add the wine and evaporate its alcohol immediately.
- Add grated tomatoes mixed with tomato paste on the mixture. Cook the mixture over high heat until it boils, then add bay leaf and stew for ½ hour more. Add water when necessary (approximately 2.5 glasses).

- Stop cooking after adding salt, black pepper and nutmeg. Make sure that the sauce remains juicy.

MEATBALLS WITH VEGETABLES: INGREDIENTS

- 500 g low-fat ground beef
- 1 mid-size onion, chopped
- ½ egg plant, chopped in small cubes
- 1 zucchini, chopped in small cubes
- 1 colored bell pepper, chopped in small cubes
- 1 small-size tomato, without skin, seeds removed and chopped in cubes
- 50 g parmesan cheese, grated
- 5 sprigs of parsley, fine-chopped
- 2 eggs, scrambled
- 1 tea cup bread crumbs
- 1 teaspoon cummin
- 1 teaspoon pimento
- 1 teaspoon black pepper
- 1 dessert spoon salt
- 2 tablespoons olive oil

PREPARATION

- Saute the vegetables in olive oil.
- Blend the sauteed vegetables and other ingredients together.
- Make the mixture you prepared into a loaf and cover tightly with plastic wrap. Leave the mixture in the fridge for 2 hours to rest and take shape.
- Remove the plastic wrap from the mixture you take out of the fridge.
- Grease the standard baking tray and place the loaf inside.
- Cook your dish on the pre-heated 1st rack of your oven.
- Rest the dish for at least 10 min. before serving.

CREME BRULEE

INGREDIENTS

- 200 ml cream
- 90 ml milk
- 50 g granulated sugar
- 3 egg yolks
- 1 vanilla stick

- Brown sugar

PREPARATION

- Heat cream, milk, granulated sugar and vanilla in a pot (do not boil).
- Whip egg yolks in a separate pot. Take some of the heated mixture, add whipped egg yolks and stir. Add the rest of the mixture, stir continuously to prevent eggs from boiling.
- Pour the prepared mixture into 4 separate pots.
- Align the Creme Brulee cups placed in the standard baking tray with water inside.
- Cook your dessert on 5th rack of your pre-heated oven.
- After cooking, you may drizzle brown sugar on creme brulee and fry the top with a blow torch or the oven grill.

BEEF WELLINGTON

INGREDIENTS

- 600 g beef tenderloin
- 400 g cultivated mushrooms
- 1 small-size onion
- 5 sprigs fresh thyme, separated from sprig
- 2 tablespoons granular mustard
- 4 large leaves of puff pastry
- 2 egg yolks
- 1 tablespoon sesame
- Salt/Black pepper
- Olive oil

PREPARATION

- Divide the beef into four parts.
- Season each part with olive oil, salt and black pepper in a hot pan, then sear all over and cool.
- Grind onions, mushrooms, fresh thyme, salt and black pepper until they become homogeneous.
- Cook the mixture until all its juice is evaporated, then cool.
- Roll the puff pastry on a floured surface, trim ends of the pastry.

- Smear the mushroom filling on the puff pastry according to the size of the beef.
- Set the beef on the filling and smear with granular mustard.
- Fold over the edges of the pastry to completely cover the beef.
- Close and tie it with the strip shape trimmed ends of the puff pastry.
- Cook your dish on the 1st rack of your pre-heated oven.
- Recommended to rest the dish for 5 minutes after cooking before serving.
- Season vegetables for the soup with olive oil, salt and black pepper and spread over the standard baking tray.
- Place garlic covered in aluminum foil on the side of the tray.
- Cook your dish on 5th rack of your pre-heated oven.
- Grind baked vegetables and peeled garlic with vegetable juice until they become homogeneous.
- Recommended to serve dish hot after cooking.

VEGETABLE SOUP

INGREDIENTS

For vegetable juice:

- 1 mid-size carrot, peeled and coarsely chopped
- 1 mid-size celery root, peeled and coarsely chopped
- 1 mid-size carrot, peeled and coarsely chopped
- 1 leek, coarsely chopped
- 2 bay leaves
- 1 dessert spoon black peppercorn
- 3 liters tepid water

For soup:

- 1 mid-size onion, peeled and coarsely chopped
- 1 zucchini, coarsely chopped
- 1 colored bell pepper, coarsely chopped
- 1 small-size tomato, coarsely chopped
- 1 celery root, coarsely chopped
- 4 cloves of garlic, with skin
- 1 teaspoon black pepper
- 1 dessert spoon salt
- 2 tablespoons olive oil
- 1.5 liters vegetable juice

PREPARATION

- For the vegetable juice, boil all ingredients in a saucepan for 45-60 min. over low heat.
- Filter the prepared vegetable juice.

SIRLOIN STEAK

INGREDIENTS

- 700 g veal sirloin
- 1 tablespoon black peppercorn
- ½ tea cup cream
- ½ tea cup white wine
- Olive oil
- Salt

PREPARATION

- Grind black peppercorn coarsely.
- Season sirloin steaks with salt, then cover all over with coarsely ground black peppercorn.
- Sear both sides of the steaks with olive oil on a frying pan.
- Cook your dish on 2nd rack of your pre-heated oven.
- Pour white wine, cream and salt in the pan in which you seared the steaks.
- Simmer the sauce until thickens.
- After resting cooked meat in oven for 5-10 min., pour the sauce on the steak and serve.

VEGETABLES AU GRATIN

INGREDIENTS

- 150 g broccoli, only flowers
- 150 g cauliflower, only flowers
- 150 g brussels sprouts
- 1 large carrot, medium thickness and chopped
- 1 large potato, medium thickness and chopped
- 500 ml milk

- 40 g flour
- 40 g butter
- 80 g parmesan cheese, grated
- 1 teaspoon nutmegs, grated
- Salt
- Black pepper

PREPARATION

- Boil the vegetables separately.
- Melt butter in a saucepan, add flour and cook until the flour turns light brown.
- Add milk at room temperature in small portions to the butter and flour mixture, and stir with a wire whip until the mixture thickens. Make sure that the sauce does not become too thick.
- Sprinkle over parmesan, salt, pepper and nutmegs on the cooked sauce.
- Add boiled vegetables on the sauce and stir.
- Pour it inside a glass oven-ware of size 30x20x7 cm³ approximately.
- Cook your dish on 4th rack of your pre-heated oven.
- Serve the baked vegetable au gratin after resting for 5-10.

TAHINI CHEESECAKE

INGREDIENTS

- 500 g mild cream cheese
- 150 g granulated sugar
- 5 eggs
- 35 g starch
- 200 ml cream
- 2 tablespoons olive oil
- 210 g fibrous biscuits
- 100 g butter

PREPARATION

- Grind the fibrous biscuits very thinly.
- Melt butter, add on the ground biscuits and stir.
- Put a grease-proof paper on pastry tray, set the round spring form pan with approximately 24-27 cm diameter and 5 cm height on it.

- Pour the butter and biscuits mixture in the spring form pan and spread it equally on the base. Cool the mixture in this form for 10 min. in the fridge.
- Whip cream cheese and sugar in another bowl.
- Whip eggs and starch in a separate bowl.
- Whip the cream in a separate bowl.
- Mix all mixtures and tahini.
- Pour the mixture you prepared on the butter and biscuit base you take out of the fridge.
- Cook your dish on the 1st rack of your pre-heated oven.
- Keep your cake for 1 night in the fridge.

 It is recommended that you use a knife soaked in water to slice the cheesecake. This would allow you to slice your cake more smoothly.

LAMB NECK STEW

INGREDIENTS

- 800 g lamb neck, sliced in circles
- 2 tablespoons flour
- 1 tablespoon butter
- 1 tablespoon olive oil
- 2 mid-size onion, chopped in small cubes
- 1 tablespoon tomato paste
- 2 mid-size tomatoes, peeled and chopped in small cubes
- 2 mid-size carrots, chopped in large cubes
- 2 mid-size potatoes, chopped in large cubes
- 1 dessert spoon dry thyme
- 250 ml vegetable juice
- Salt

For vegetable juice:

- 1 mid-size carrot, peeled and coarsely chopped
- 1 mid-size celery root, peeled and coarsely chopped

- 1 mid-size carrot, peeled and coarsely chopped
- 1 leek, coarsely chopped
- 2 bay leaves
- 1 dessert spoon black peppercorn
- 3 liters tepid water

PREPARATION

- For the vegetable juice, boil all ingredients in a saucepan for 45-60 min. over low heat.
- Filter the prepared vegetable juice.
- Season lamb neck slices with salt and pepper, flour and remove the excess flour.
- Heat butter and olive oil in a pan and sear lamb neck slices.
- Saute the onions in the pan you seared the meat, then add tomatoes and tomato paste, and cook.
- Add vegetable juice, salt and pepper in the mixture.
- Put seared lamb neck slices in a glass oven-ware of dimensions 30x20x7 cm³ approximately, then place tomato sauce and vegetables.

LEMON CAKE

INGREDIENTS

- 170 g flour
- 170 g granulated sugar
- 3 eggs
- 5 g baking powder
- 170 g butter (at room temperature)
- Lemon zest obtained from 2 lemons
- 2 g vanilla

PREPARATION

- Whip eggs and sugar in a bowl.
- Add flour, baking powder and lemon zest into the mixture.
- Add butter at room temperature and whip the mixture well.
- Butter a Teflon cake mould of size 27x15x6 cm³ approximately and pour the mixture in the mould.
- Cook your dish on the 1st rack of your pre-heated oven.

HARICOT BEANS

INGREDIENTS

- 115 g haricot beans
- 150 g pastrami, chopped
- 2 mid-size onions, chopped in small cubes
- 4 green peppers, chopped thinly in cubes
- 2 mid-size tomatoes, peeled and chopped in cubes
- 1 tablespoon red pepper paste
- 1 tablespoon tomato paste
- 1,5 tablespoons butter
- 1 dessert spoon chili pepper
- 500 ml vegetable juice (hot)
- 1 dessert spoon baking soda
- Salt
- Black pepper

PREPARATION

- Keep haricot beans in water with baking soda for a night before cooking.
- Boil the beans kept in water shortly.
- Heat the stew over stove and add butter.
- Add onions chopped in cubes and fry.
- Add pepper, tomatoes, red pepper paste and tomato paste and cook.
- Add pastrami, boiled beans, salt, black pepper and chili pepper in the stewpan.
- Add the hot vegetable juice in the mixture, then simmer for about 10 min. over medium heat.
- Cover the stewpan with aluminum foil.
- Place the stewpan on the top separator of your pre-heated oven and cook the dish.

CORN BREAD

INGREDIENTS

- 150 g corn flour
- 150 g flour
- 10 g baking powder
- 7 g salt
- 5 g granulated sugar
- 2 eggs

- 100 ml milk
- 50 g butter, melted
- 50 g canned corn, seeds

PREPARATION

- Blend corn flour, flour, baking powder, salt and sugar in a bowl.
- Mix eggs, milk, butter and corn in another bowl and whisk it well.
- Add the liquid mixture on the powder mixture and stir well.
- Butter a Teflon cake mould with minimum 8 muffin moulds, and pour the mixture in equal amounts inside.
- Cook your dish on the 1st rack of your pre-heated oven.

SEA BASS IN SALT

INGREDIENTS

- 2 sea basses (approximately 2 kg)
- 1 kg rock salt
- 1 kg salt
- 6 sprigs fresh thyme, shredded thinly
- 6 sprigs fresh thyme, fine-chopped
- 10 sprigs of parsley, fine-chopped
- 6 sprigs dill, fine-chopped
- Lemon zest obtained from 1 lemon, grated
- 1 garlic
- 6 egg white

PREPARATION

- Crush garlic. Prepare a filling adding finely chopped herbs, lemon zest and garlic together.
- Keep two tablespoons of the filling aside.
- Clean inside the sea bass and the fish scales. Fill the sea bass with the filling you prepared.
- Whisk egg white in a bowl until it is puffed up, add the rest of the filling and salts, and stir well.
- Pour some of the seasoning on a cake tray, place the sea bass on it and cover it all over with the seasoning.
- Cook your dish on 4th rack of your pre-heated oven.

- Remove the salt on your dish and serve.

PERDE RICE

INGREDIENTS

- 3 chicken drumsticks

For the filling:

- 2 glasses rice
- 2 tablespoons butter
- 2 tablespoons pine nut
- 2 tablespoons blackcurrant (kept in warm tepid water)
- 4 tablespoons almond, boiled and peeled
- 3 glasses chicken broth
- Salt
- Black pepper

For the dough:

- 125 g butter, at room temperature
- 2 eggs
- 400 g flour
- 1.5 teaspoons salt
- 100 g yoghurt

PREPARATION

- Boil the drumsticks, remove the skins and shiver into small pieces after it cools.
- Filter the chicken broth to use in the filling.
- Cook almonds, blackcurrants and pine nuts in butter and pour into a bowl.
- Wash the rice and keep them in tepid and salty water for half an hour.
- Cook the rice in the butter you cooked almonds, blackcurrants and pine nuts.
- Add hot chicken broth and salt, simmer for 10 minutes, then rest for another 10 minutes.
- After the filling is rested add almonds, blackcurrants and pine nuts and stir.
- Mix flour, butter and salt for the dough, continue stirring while adding eggs, then add yoghurt and knead it well; cover the dough with plastic wrap and keep in the fridge for 30 minutes.

- Roll out the dough on a floured surface and divide it into one large and one small parts.
- Grease a glassware of about 25x36x6 cm³, place the larger dough inside the glassware as its sides are hanging over the edges of the pot.
- Set the ingredients as one layer of rice filling and one layer of chicken in turn.
- Cover the rice filling completely with the smaller dough.
- Trim the excess of dough hanging over the edges, and combine them with the dough on top.
- Cook your dish on the 1st rack of your pre-heated oven.

LEG OF LAMB TANDORI

INGREDIENTS

- 2 kg whole leg of lamb
- 3 sprigs fresh thyme
- 3 sprigs fresh rosemary
- 8 cloves of garlic

PREPARATION

- Draw diamond-shaped lines with a sharp knife on the fatty parts of the leg of lamb.
- Put fresh herbs and garlic inside the diamond-shaped lines.
- Place the leg of lamb on the wire grill.
- Cook your dish placing a tray on the 4th rack under the wired grill of your preheated oven.

VEGETARIAN QUICHE

INGREDIENTS

For the dough:

- 270 g flour
- 1 teaspoon salt
- 180 g butter, cold and cut into cubes
- 50 g iced water

For the filling:

- 3 eggs
- 2 tablespoons cream
- 70 g broccoli, only flowers
- 1 small-size onion, chopped in small cubes

- 2 colored bell pepper, chopped in small cubes
- 5 sprigs parsley, fine-chopped
- Salt
- Black pepper

PREPARATION

- Knead flour, salt and butter for the dough.
- Add iced water when dough becomes homogeneous and knead further.
- Wrap the dough with plastic wrap and keep in the fridge for 1 hour.
- Boil vegetables in salty water in separate pots, keep them in salty water so that they can keep their color.
- Whisk eggs with cream for the filling. Add vegetables, parsley, salt and black pepper and mix.
- Butter a pie pan with approximately 25 cm diameter and 3 cm height.
- Roll out the dough you kept in the fridge on a floured surface, put it in the pie pan, trim the edges, bore holes in the dough with a fork.
- Cook your dish on the 1st rack of your pre-heated oven.
- At the 25th minute of the cooking, take out the pie pan, add the vegetable mix and continue cooking.

BROWNIE CHEESECAKE

INGREDIENTS

For the base:

- 30 cacao, sifted
- 185 g butter, melted
- 130 g granulated sugar
- 2 eggs
- 130 g flour
- 100 g chocolate chips

For the filling:

- 375 processed cheese
- 165 g granulated sugar
- 3 eggs
- Half teaspoon vanilla

For the sauce:

- 100 g cream

- 100 g bitter chocolate
- Half tablespoon honey

PREPARATION

- Mix cacao, granulated sugar and flour for the cheesecake base. Then add butter, eggs and chocolate chips and whisk the mixture well.
- Put a grease-proof paper on pastry tray, set the round spring form pan with approximately 24-27 cm diameter and 5 cm height on it.
- Pour the mixture you prepared for cheesecake base in the pan and spread.
- Beat processed cheese, granulated sugar and vanilla for the filling. Add eggs one by one while beating until you obtain a homogeneous mixture.
- Pour the mixture you prepared for the filling on the cheesecake base.
- Cook your dish on 4th rack of your pre-heated oven.
- For the sauce, melt the cream, chocolate and honey bain marie style in a bowl.
- Add the sauce you prepared and spread it homogeneously on the cooked, then cooled cheesecake at room temperature.
- Keep your brownie cheesecake in the fridge for 3-4 hours.

i It is recommended that you use a knife soaked in water to slice the cheesecake. This would allow you to slice your cake more smoothly.

SPINACH FLAN

INGREDIENTS

For the filling:

- 250 g spinach
- 4 eggs
- 1 tablespoon milk
- 100 g parmesan cheese, grated
- 1 teaspoon nutmegs, grated
- 1 tablespoon pine nut
- 2 tablespoons olive oil

- Black pepper
- Salt

For the sauce:

- 200 g goat cheese, grated
- 150 ml milk

PREPARATION

- Cut the leaves of spinach, then wash and dry.
- Pour olive oil in a saucepan, add spinach.
- Stew the spinach for 5 min.
- Transfer the cooked spinach in a colander and remove the excess water with a spoon.
- Mix all ingredients and homogenize them while grinding until it becomes creamy.
- Cover grease-proof paper on 4 small aluminum pots.
- Divide the mixture you prepared in equal amounts to 4 pots.
- Align the cups placed in the standard baking tray with water inside.
- Cook your dish on the 1st rack of your pre-heated oven.
- Melt goat cheese and milk on a fry pan for the sauce.
- Pour the sauce on your cooked spinach flan and serve.

CHICKEN LEGS

INGREDIENTS

- 4 chicken drumsticks, boneless
- 6 mid-size potatoes
- 3 sprigs fresh thyme, fine-chopped
- Salt

For the filling:

- 5 tablespoons olive oil
- 2 cloves garlic
- 5 tablespoons bread crumbs
- 3 sprigs dry sage tea, fine-chopped
- 3 sprigs fresh thyme, fine-chopped
- 3 sprigs parsley, fine-chopped
- Salt
- Black pepper

PREPARATION

- Heat olive oil in a pan for the filling.
- Chop the garlic thinly, saute in the pan.
- Add bread crumbs on and cook.
- Add sage tea, fresh thyme, parsley, salt and pepper on the bread crumb mixture, prepare the filling.
- Place the filling on the center of boneless chicken legs and wrap them up.
- Chop potatoes in large cubes, season with rosemary, olive oil and salt.
- Place potato cubes in the tray. Place wired grill on the oven tray, put chicken legs on the wired grill .
- Cook your dish on 4th rack of your pre-heated oven.

How to operate the grill

 Close oven door during grilling.
Hot surfaces may cause burns!

 Grilling can be made in single whole section, only top section or in the top section when bottom-top sections are operated.

Grilling in single large section



Oven returns to stand-by display after it is powered on for the first time and the current time is set. Only the current time appears on the display.

1. Remove the middle section plate from the oven. Only after the middle section plate is removed the oven timer will work in single large section cooking setting.
2. Turn on the oven touching the  key for two seconds.
3. When the oven is turned on, the first function peculiar to the single large section cooking will be displayed.



4. Touch  to select the desired grill function.





5. After the function is selected "Temperature", "Rapid Heating (Booster)", "Cooking time" and "Cooking end time" can be set. see. (Operating the oven as a single section) *How to operate the oven control unit, page 23*
6. If cooking function, temperature and time values are suitable, touch  key to start cooking. Cooking starts and "Cooking" appears on the display.
7. If set, at the end of cooking time, the oven is switched off automatically. "Enjoy your meal" appears on the display and an audible signal is given twice. The oven is switched off automatically. If no cooking time is set, when the cooking process is completed touch  key again to end the cooking.

8. Touch  key to switch off the oven.

Grilling in top section only mode

Oven returns to stand-by display after it is powered on for the first time and the current time is set. Only the current time appears on the display.

1. Place the middle section plate in its housing found between the 3rd and 4th rack guides.
 -  If the middle section plate is not placed, the oven timer will operate as a whole single section.
2. Turn on the oven touching the  key for two seconds.
3. When the oven is turned on, the first function peculiar to the single large section cooking will be displayed.

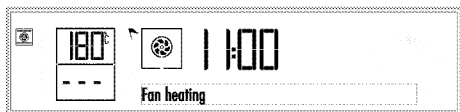

4. Touch to select the desired grill function.

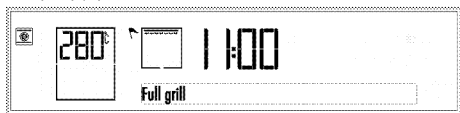

5. After the function is selected "Temperature", "Rapid Heating (Booster)", "Cooking time" and "Cooking end time" can be set. see. (Using the oven only as the top or bottom section) *How to operate the oven control unit, page 23*
6. If cooking function, temperature and time values are suitable, touch to start cooking. Cooking starts and "Cooking" appears on the display.
7. If set, at the end of cooking time, the oven is switched off automatically. "Enjoy your meal" appears on the display and an audible signal is given twice. The oven is switched off automatically. If no cooking time is set, when the cooking process is completed touch key again to end the cooking.
8. Touch key to switch off the oven.

Grilling only in the top section while the top and bottom sections of the oven are in operation

Oven returns to stand-by display after it is powered on for the first time and the current time is set. Only the current time appears on the display.

1. **Place the middle section plate in its housing found between the 3rd and 4th rack guides.**

If the middle section plate is not placed in position, the oven will operate as a whole single section.

2. Turn on the oven touching the key for two seconds.
3. When the oven is first turned on, the single large section cooking function will be displayed.

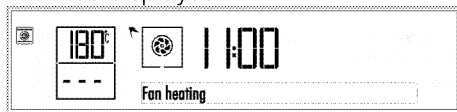

Each time you touch the key is, bottom section only, both bottom and top sections and top section only will be activated respectively.

4. Activate both sections by touching key twice. symbol will appear next to each oven section.

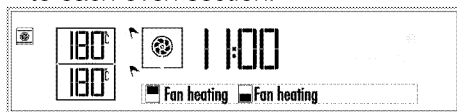

5. Touching keys, select the desired function pair with the top section is selected as grill function.



6. After the function is selected, "Temperature" and "Cook time" can be adjusted separately for each oven section. For these settings symbol of the active cooking section will flash. See: (Using the top and bottom sections of the oven simultaneously) *How to operate the oven control unit, page 23*
7. If cooking function, temperature and time values are suitable, touch key to start cooking. Cooking starts and "Cooking" appears on the display.
8. If set, at the end of cooking time, the oven is switched off automatically. "Enjoy your meal" appears on the display and an audible signal is given twice. The oven is switched off automatically. If no cooking time is set,

when the cooking process is completed touch  key again to end the cooking.

9. Touch  key to switch off the oven.



Foods that are not suitable for grilling carry the risk of fire. Only grill food which is suitable for intensive grilling heat. Do not place the food too far in the back of the grill. This is the hottest area and fatty food may catch fire.

For single large section: cooking times table for grilling

Food	Accessory to use	Insertion level	Temperature (°C)	Cooking time (approx. in min.)
Fish	Wire grill	4...5	250	20...25 min. #
Chopped chicken	Wire grill	4...5	250	25...35 min.
Lamb chop	Wire grill	4...5	250	20...25 min.
Roast Beef	Wire grill	4...5	250	25...30 min. #
Veal chop	Wire grill	4...5	250	25...30 min. #
Toast bread	Wire grill	4	250	1...3 min.

depending on thickness

It is suggested to perform a preheating for all foods for approx. 5 minutes.

For top section only: cooking times table for grilling

Food	Accessory to use	Insertion level	Temperature (°C)	Cooking time (approx. in min.)
Fish	Wire grill	4...5	250	20...25 min. #
Chopped chicken	Wire grill	4...5	250	25...35 min.
Lamb chop	Wire grill	4...5	250	20...25 min.
Roast Beef	Wire grill	4...5	250	25...30 min. #
Veal chop	Wire grill	4...5	250	25...30 min. #
Toast bread	Wire grill	4	250	1...3 min.

depending on thickness

It is suggested to perform 5 minutes preheating for all foods broiling.

For single large section: cooking times table for grilling of test meals

Meals in this cooking table are prepared according to EN 60350-1 to make it easier for control institutes to test the product.

Food	Accessory to use	Insertion level	Temperature (°C)	Cooking time (approx. in min.)
Toast bread	Wire grill	4	250	1...3 min.
Meatballs (beef) - 12 pieces	Wire grill	4	250	25...35 min.

Turn the food after 2/3 of the total grilling time.

It is suggested to perform 5 minutes preheating for all foods broiling.

6 Maintenance and care

General information

Service life of the product will extend and the possibility of problems will decrease if the product is cleaned at regular intervals.

! Disconnect the product from mains supply before starting maintenance and cleaning works. There is the risk of electric shock!

! Allow the product to cool down before you clean it. Hot surfaces may cause burns!

- Clean the product thoroughly after each use. In this way it will be possible to remove cooking residues more easily, thus avoiding these from burning the next time the appliance is used.
- No special cleaning agents are required for cleaning the product. Use warm water with washing liquid, a soft cloth or sponge to clean the product and wipe it with a dry cloth.
- Always ensure any excess liquid is thoroughly wiped off after cleaning and any spillage is immediately wiped dry.
- Do not use cleaning agents that contain acid or chloride to clean the stainless or inox surfaces and the handle. Use a soft cloth with a liquid detergent (not abrasive) to wipe those parts clean, paying attention to sweep in one direction.

i The surface might get damaged by some detergents or cleaning materials. Do not use aggressive detergents, cleaning powders/creams or any sharp objects during cleaning. Do not use harsh abrasive cleaners or sharp metal scrapers to clean the oven door glass since they can scratch the surface, which may result in shattering of the glass.

i Do not use steam cleaners to clean the appliance as this may cause an electric shock.

Cleaning the control panel

Clean the control panel and knobs with a damp cloth and wipe them dry.

i If your product is equipped with buttons/knobs do not remove the control buttons/knobs to clean the control panel. Control panel may get damaged!

Cleaning the oven

To clean the side walls of the oven

1. Remove the middle section plate from the oven.
2. Pull the wire rack together with the top side wall it is connected to and take the pin nr. (1) out of its housing.

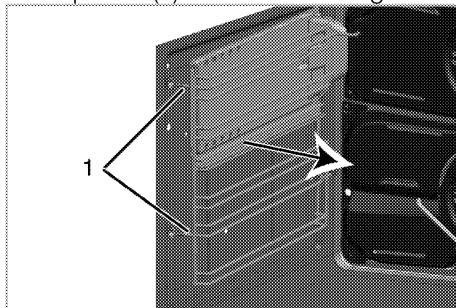

3. Pull the wire rack towards yourself together with the side wall and take the rack and the side wall out of the oven. Ensure that pin no 2 is removed from its housing in the back wall and that the tip no 3 is removed from the screw in side wall.

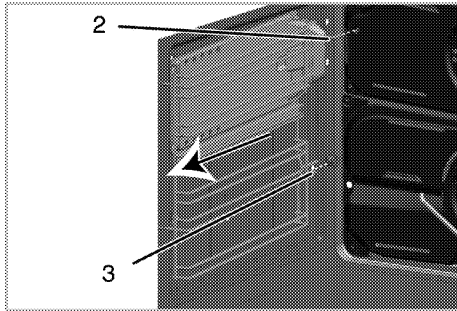

4. Pull the wire rack to take it out from the hole (4) on the side wall and separate the wire rack and the side wall.

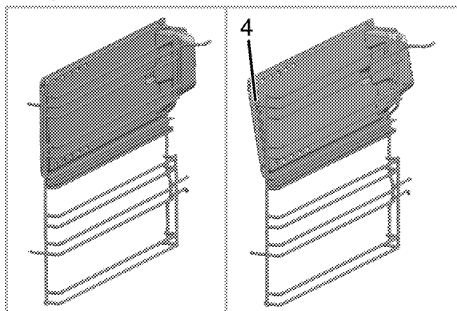

5. Clean the wire rack and the side wall by using a dish detergent, lukewarm water and a soft cloth or sponge, and dry it with a dry cloth.

6. After the cleaning process insert the pin no 1 of wire rack into the hole (4) found in the side wall. Make sure that the side wall plate is secured in its the wire rack housing.

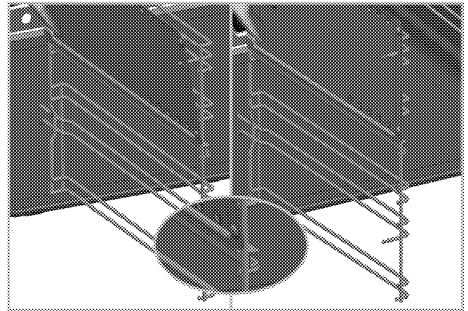

7. Secure the side wall and the wire rack assembly to the oven, so as their pins (2) can go into the housings on the chassis and the tip no 3 goes into the screw found on the side wall.

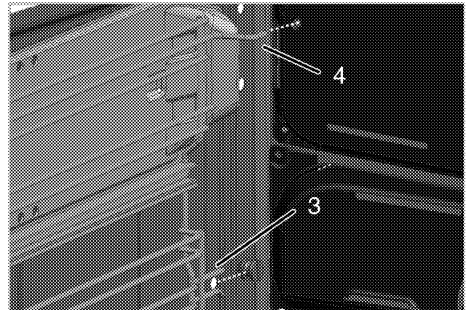

8. Insert the wire rack pin (1) to its housing found in the chassis.

i Make sure that the wire rack and the side wall assembly is seated well into the housing.

Catalytic walls

(This feature is optional. It may not exist on your product.)

The inner side walls (A) and/or the rear wall (B) of your product may be coated with catalytic enamel. Catalytic walls have a light matte colour and a porous surface. Catalytic walls of the oven should not be cleaned. Porous surfaces of the catalytic walls are automatically cleaned by absorbing and converting the spilled oil (steam and carbon dioxide).

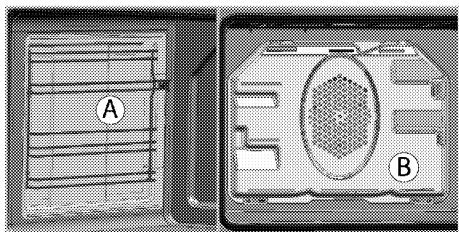

Clean oven door

To clean the oven door, use warm water with washing liquid, a soft cloth or sponge to clean the product and wipe it with a dry cloth.

Wipe the glass with vinegar and then rinse it against lime residues that may occur on the oven glass.

i Don't use any harsh abrasive cleaners or sharp metal scrapers for cleaning the oven door. They could scratch the surface and destroy the glass.

i Front door inner glass is coated to easy clean material. Do not use any harsh abrasive cleaners, hard metal scrapers, scouring pads or bleach to clean front door inner glass as they may scratch the surface. This may destroy the coating material.

Cleaning the oven door

i Do not use harsh abrasive cleaners, metal scrapers, wire wool or bleach materials to clean the oven door and glass.

i The oven door inner glass is covered with an easy-to-clean material. Do not use abrasive cleaning agents, hard metal scrapers, wire wool or bleach materials such as bleach.

You can remove your oven door and door glasses to clean them. How to remove the doors and windows is

explained in the sections "Removing the oven door" and "Removing the inner glasses of the door". After removing the door inner glasses, clean them using a dishwashing detergent, warm water and a soft cloth or sponge and dry them with a dry cloth. Wipe the glass with vinegar and then rinse it against lime residues that may occur on the oven glass.

Removing the oven door

1. Open the front door (1).
2. Open the clips at the hinge housing (2) on the right and left hand sides of the front door by pressing them down as illustrated in the figure.

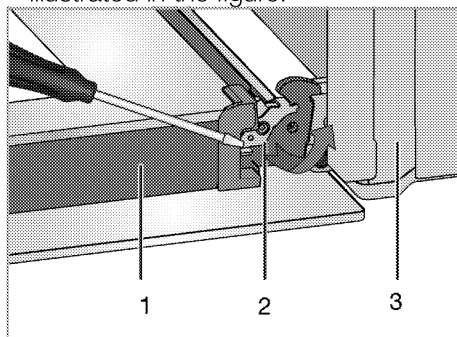

- 1 Door
- 2 Hinge lock(closed position)
- 3 Oven
- 4 Hinge lock(open position)

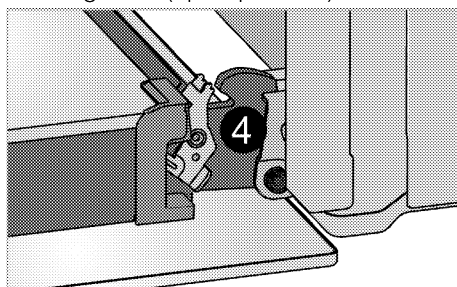

3. Move the front door to half-way.

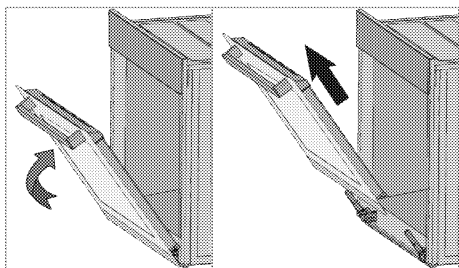

4. Remove the front door by pulling it upwards to release it from the right and left hinges.

i Steps carried out during removing process should be performed in reverse order to install the door. Do not forget to close the clips at the hinge housing when reinstalling the door.

Removing the door inner glass

(This feature is optional. It may not exist on your product.)

The inner glass panel of the oven door can be removed for cleaning.

1. Open the oven door.

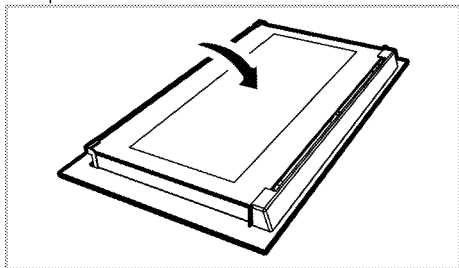

2. Pull towards yourself and remove the plastic part installed to upper section of the front door.

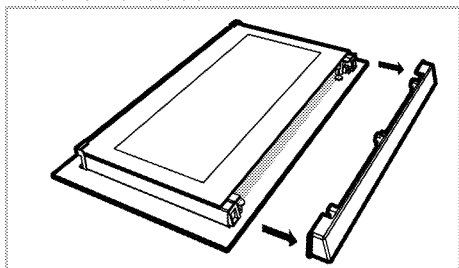

3. As illustrated in figure, raise the innermost glass panel (1) slightly in direction **A** and pull it out in direction **B**.

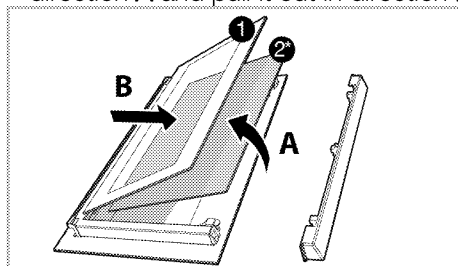

1 Innermost glass panel
2* Inner glass panel (This may not exist on your product.)

4. If your product is equipped with an inner glass panel; repeat the same procedure to remove the inner glass panel (2).

5. The first step to regroup the door is reinstalling inner glass panel (2). Place the chamfered corner of the glass panel so that it will rest in the chamfered corner of the plastic slot. (If your product is equipped with an inner glass panel). Inner glass panel (2) must be installed into the plastic slot close the innermost glass panel (1).

6. When installing the innermost glass panel (1), make sure that the printed side of the panel faces towards the inner glass panel. It is important to seat lower corner of innermost glass panel (1) into the lower plastic slot.

7. Push the plastic part towards the frame until you hear a "click".

Replacing the oven lamp

! Before replacing the oven lamp, make sure that the product is disconnected from mains and cooled down in order to avoid the risk of an electrical shock. Hot surfaces may cause burns!

i The oven lamp is a special electric light bulb that can resist up to 300 °C. See *Technical specifications, page 12* for details. Oven lamps can be obtained from Authorised Service Agents or technician with licence.

i Position of lamp might vary from the figure.

i The lamp used in this appliance is not suitable for household room illumination. The intended purpose of this lamp is to assist the user to see foodstuffs.

i The lamps used in this appliance have to withstand extreme physical conditions such as temperatures above 50 °C.

If your oven is equipped with a round lamp:

1. Disconnect the product from mains.
2. Turn the glass cover counter clockwise to remove it.

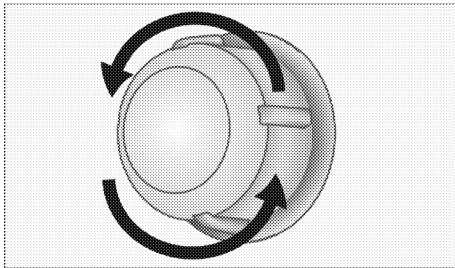

3. If your oven lamp is of type (A) shown in the figure below, remove it by rotating as shown and replace it. If it is of type (B), pull and remove it as shown in the figure and replace it.

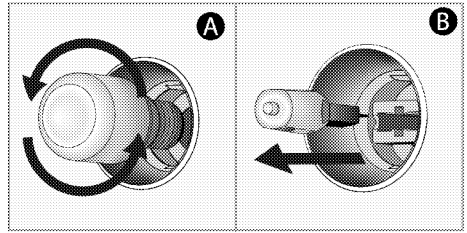

4. Install the glass cover.

If your oven is equipped with a square lamp:

1. Disconnect the product from mains.
2. Remove the wire racks as described. See .

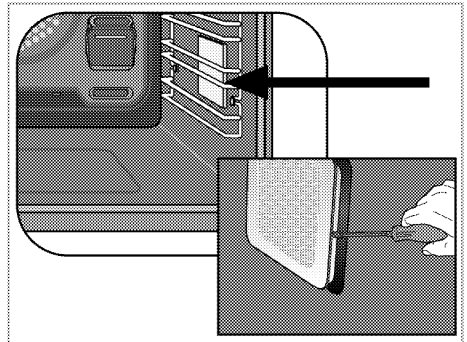

3. Remove the protective glass cover with a screwdriver.
4. If your oven lamp is of type (A) shown in the figure below, remove it by rotating as shown and replace it. If it is of type (B), pull and remove it as shown in the figure and replace it.

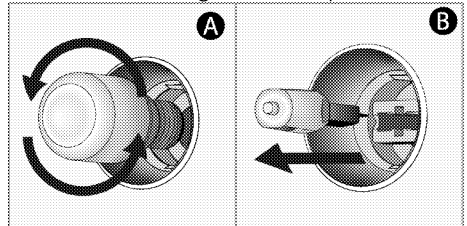

5. Install the glass cover and then the wire racks.

7 Troubleshooting

Oven emits steam when it is in use.

- It is normal that steam escapes during operation. >>> *This is not a fault.*

Product emits metal noises while heating and cooling.

- When the metal parts are heated, they may expand and cause noise. >>> *This is not a fault.*

Product does not operate.

- The mains fuse is defective or has tripped. >>> *Check fuses in the fuse box. If necessary, replace or reset them.*
- Product is not plugged into the (grounded) socket. >>> *Check the plug connection.*

Oven light does not work.

- Oven lamp is defective. >>> *Replace oven lamp.*
- Power is cut. >>> *Check if there is power. Check the fuses in the fuse box. If necessary, replace or reset the fuses.*

Oven does not heat.

- Might not be set to a certain cooking function and/or temperature. >>> *Set the oven to a certain cooking function and/or temperature.*
- Power is cut. >>> *Check if there is power. Check the fuses in the fuse box. If necessary, replace or reset the fuses.*

i Consult the Authorised Service Agent or technician with licence or the dealer where you have purchased the product if you can not remedy the trouble although you have implemented the instructions in this section. Never attempt to repair a defective product yourself.

