

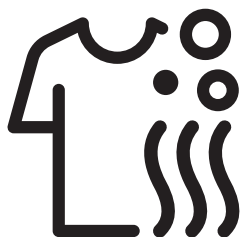

Washer-Dryer

User Manual



HTX851436A-IT



Document Number : 2820531086_EN/ 07-03-23.(12:59)







RECYCLED &
RECYCLABLE PAPER

Please read these instructions first before using your appliance

Dear Customer,

Thank you for choosing a Beko appliance. Please take some time to read this user manual before using your appliance, to ensure you know how to safely operate the controls and functions. Carefully follow all unpacking and installation instructions to ensure the appliance is correctly connected and fitted prior to use. Please write your product model and serial number on the last page of this user manual, and store in a safe location close to the appliance for easy future reference. This user manual may also be applicable for several other models. Differences between models will be listed. If you have any questions or concerns, please call our contact centre or find help and information online at www.beko.co.uk

Explanation of symbols used throughout this User Manual

	INFORMATION
	<ul style="list-style-type: none">• Important information or useful hints about usage.
	<ul style="list-style-type: none">• Read user manual.
	<ul style="list-style-type: none">• Packaging materials of the product are manufactured from recyclable materials in accordance with regulations.• Do not dispose of the Packaging materials together with the domestic or other wastes. Take them to the packaging material collection points designated by the local authorities.
	<ul style="list-style-type: none">• Allergy UK, is the brand of British Allergy Association. Their main endorsement is the 'Seal of Approval'. When you see a product with this logo on it, you have the reassurance the product has been scientifically tested to prove it is efficient at reducing/removing allergens from the environment of allergy and asthma sufferers or the products have significantly reduced allergen/chemical content.

	DANGER!
<ul style="list-style-type: none">• Warning for electric shock.	

	DANGER!
<ul style="list-style-type: none">• Product weight warning	

	DANGER!
<ul style="list-style-type: none">• Fire risk warning.	

	CAUTION!
<ul style="list-style-type: none">• Warning for hazardous situations with regard to life and property.	

	PRECAUTION!
<ul style="list-style-type: none">• Precautions that need to be taken.	

1 Important instructions for safety and environment

This section contains safety instructions that will help protect from risk of personal injury or property damage. Failure to follow these instructions shall void any warranty.

1.1 General safety



CAUTION!

- This product can be used by children at and above 8 years old and by persons whose physical, sensory or mental capabilities are not fully developed or who lack experience and knowledge provided that they are supervised or trained on the safe use of the product and the risks involved. Children should not play with the product. Cleaning and maintenance works should not be performed by children unless they are supervised by someone. Children under the age of 3 must be kept away from the product unless they are continuously supervised.



WARNING!

- Never place the product on a carpet-covered floor. Otherwise, lack of airflow beneath the product will cause electrical parts to overheat. This will cause problems with your product.



INFORMATION

- Always have the installation procedures carried out by authorised persons. The manufacturer shall not be held liable for damages that may arise from procedures carried out by unauthorised persons.

1.1.1 Electrical safety



DANGER!

- If the product has a failure, it should not be operated unless it is repaired by the Authorised Service Agent. There is risk of electric shock!
- Never wash the product by spreading or pouring water onto it! There is risk of electric shock!



CAUTION!

- If the power cable is damaged, it must be replaced by the manufacturer, after sales service or a similarly qualified person (preferably an electrician) or someone designated by the importer in order to avoid possible risks.



WARNING!

- Unplug the product when it is not in use.
- Never touch the plug with wet hands! Never unplug by pulling on the cable, always pull out by grabbing the plug.
- Unplug the product during installation, maintenance, cleaning and repair.
- Do not make connections via extension cables or multi-plugs.



INFORMATION

- This product is designed to resume operating in the event of powering on after a power interruption. If you wish to cancel the programme, see "Cancelling the programme" section.

1.1.2 Product safety



DANGER!

- Never open the loading door or remove the filter while there is still water in the drum. Otherwise, risk of flooding and injury from hot water will occur.



CAUTION!

- The water supply and draining hoses must be securely fastened and remain undamaged. Otherwise, there is the risk of water leakage.



INFORMATION

- Do not force open the locked loading door. The door will open immediately after the washing cycle has ended. If the machine is not cooled enough at the end of the programme, the loading door cannot be opened. Wait for the product to cool down. If the door still does not open, apply the solutions provided for "Loading door cannot be opened" in the Troubleshooting section. Do not force the loading door to open. The loading door and the lock mechanism may get damaged.
- In the location where this product is going to be installed, there must be no doors with a lock, bolt or hinge that will prevent the loading door from opening completely.
- Follow the instructions on the textile tags and on the detergent package.
- Use detergents, softeners and supplements suitable for washing machines only.



INFORMATION

- Do not install or leave the product in places where it might be exposed to outdoor conditions.
- Do not play with control elements of the product.
- If a non-self-resetting thermal cut-out is required in order to comply with the standard then the instructions for appliances incorporating a non-self-resetting thermal cutout that is reset by disconnection of the supply mains shall contain the substance of the following:

CAUTION: In order to avoid a hazard due to inadvertent resetting of the thermal cut-out, this appliance must not be supplied through an external switching device, such as a timer, or connected to a circuit that is regularly switched on and off by the utility.

1.1.3 Warnings about drying



DANGER!

- Laundry that has previously been washed, cleaned, soiled or stained with petrol/gas, dry cleaning solvents or other inflammable/combustive substances must not be dried in the machine since they emit inflammable/combustive vapour. Otherwise, there will be the risk of fire.
- Laundry soiled with vegetable oil, alcohol, petrol, gas oil, stain remover, turpentine, wax or wax remover must be washed with hot water and a great amount of detergent before drying. Otherwise, there will be the risk of fire.

**DANGER!**

- Rubber (latex) foam, shower caps, waterproof fabrics, clothes and rubber-reinforced/rubber-foam pillows must not be dried with the drying function. Otherwise, there will be the risk of fire.
- If you use laundry balls, measuring scoops or laundry cage in your machine, these products might melt during the drying process. If you are going to select the drying function, do not use these products. Otherwise, there will be the risk of fire.
- If you are using industrial chemicals for cleaning, do not use the drying function. Otherwise, there will be the risk of fire.

**DANGER!**

- Do not touch the glass of the loading door with bare hands after drying. There is the risk of burning.
- There is a final step, which is cooling, to keep the laundry at a certain temperature to ensure that it is not damaged. You may be exposed to hot steam if you open the door before cooling is complete. There is the risk of scalding.
- If the drying programmes are interrupted (due to programme cancellation or power failure), the laundry in the machine might be hot. Be careful.

**CAUTION!**

- Do not stop the machine before the drying programme is completed. If you have to do so, remove all laundry, place it at an appropriate place and wait for it to cool down.
- Your product is designed to work at temperatures between 0°C and +35°C.
- Ambient temperatures between 15°C and +25°C are suitable for your product.
- Do not let pets enter the product. Check inside of the product before using it.
- Do not overload the machine to dry laundry. Observe the maximum load levels stated for drying.

**WARNING!**

- Do not use the machine to dry leather clothes or clothes that contain leather (such as leather labels on jeans). The colour of the leather parts might affect other fabrics.
- If there is a problem you cannot solve by using the information given in the safety instructions section, switch off and unplug the machine and call the Authorised Service Agent.
- You can use your washer-dryer to only wash, only dry or both wash and dry laundry. The machine must not be used to dry wet laundry only for a long time. When using the machine only for drying purposes, run a washing programme with the machine unloaded after every 15 drying cycles.



WARNING!

- Before loading the machine, check each laundry item and make sure that there is no lighter, change, metal objects, needles etc. inside them or in their pockets.
- Underwear with metal supports must not be dried in the machine. Metal supports might come off during the drying process and damage the machine. Place them in a bag or a pillowcase.
- Do not use the machine to dry large laundry such as tulle, curtains, sheets/bedding, blanket or rugs. Your laundry might get damaged.



INFORMATION

- Do not dry unwashed laundry in the machine.
- Do not use softeners or antistatic agents unless recommended by the manufacturer.
- Products such as softeners must be used in accordance with the manufacturer's instructions.
- Do not use the machine to dry silk, wool and similar delicate clothes. Otherwise, woollen clothes may shrink, and other delicate clothes might get damaged.
- Check the symbols on the label of the clothes before washing and drying.
- The water supply pressure required to run the product is between 1 to 10 bars (0.1 – 1 MPa).
- Do not use old or used water inlet hoses on the new product. It may cause stains on your laundry.

1.2 Intended use



INFORMATION

- This product has been designed for domestic use. It is not suitable for commercial use and it must not be used out of its intended use.
- The product must be used to wash, rinse and dry only the textile products that have the relevant marking.
- The manufacturer waives any responsibility arisen from incorrect usage or transportation.
- The service life of your product is 10 years. During this period, original spare parts will be available for the product to operate properly.
- This appliance is intended to be used in household and similar applications such as:
 - staff kitchen areas in shops, offices and other working environments;
 - farm houses;
 - by clients in hotels, motels and other residential type environments;
 - bed and breakfast type environments;
 - areas for communal use in blocks of flats or in launderettes.

1.3 Children's safety



CAUTION!

- Children under the age of 3 must be kept away from the product unless they are continuously supervised.
- Packaging materials are dangerous to children. Keep packaging materials in a safe place away from reach of the children.
- Electrical products are dangerous for children. Keep children away from the product when it is in use. Do not allow them to play with the product. Use child lock to prevent children from intervening with the product.
- Do not forget to close the loading door when leaving the room where the product is located.
- Store all detergents and additives in a safe place away from the reach of the children by closing the cover of the detergent container or sealing the detergent package.

1.4 Compliance with the WEEE Directive and disposing of the waste product

This product does not contain the harmful and prohibited materials described in the "Directive on the Management of Waste Electrical and Electronic Equipment". It complies with the WEEE Directive.



This product has been manufactured with high quality parts and materials which can be reused and are suitable for recycling. Therefore, do not dispose of the product with normal domestic waste at the end of its service life. Take it to a collection point for the recycling of electrical and electronic equipment. Please consult your local authorities to learn about the nearest collection point.

Help protect the environment and natural resources by recycling used products. For children's safety, cut the power cable and break the lock mechanism of the loading door to make the product non-functional before disposal.
Compliance with the RoHS Directive
This product complies with the RoHS Directive No. 2011/65/EU. It does not contain harmful or prohibited materials stated in the directive.

1.5 Package information

Packaging materials of the product are manufactured from recyclable materials in accordance with our National Environment Regulations. Do not dispose of the packaging together with normal domestic waste. Take them to the packaging material collection points designated by local authorities.

2 Your washer-dryer

2.1 Overview

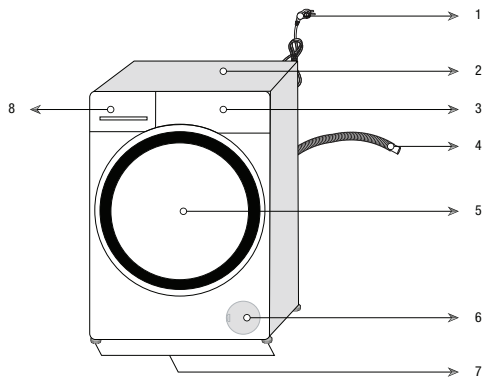

1- Power cable	5- Loading door
2- Top panel	6- Filter cover
3- Control panel	7- Adjustable feet
4- Water discharge hose	8- Detergent drawer

2.2 Package contents



Power cable

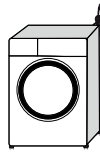

Water discharge hose

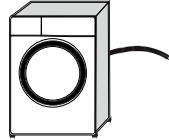

Transit bolts

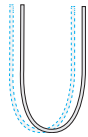

Mains water inlet hose

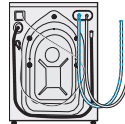

Liquid detergent container (*)



User manual



Plastic plug group

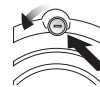

INFORMATION

- Figures in this manual are schematic and may not match the product exactly.

(*) This may be supplied with the machine depending on the model of your product.

2.3 Technical specifications

Supplier name or trademark	Beko
Model name	HTX851436A-IT
	7165146800
Maximum spin speed (rpm)	1400
Washing capacity (cotton) (kg)	8
Drying capacity (cotton) (kg)	5
Built-in	No
Height (cm)	84
Width (cm)	60
Depth (cm)	59
Single Water inlet / Double Water inlet	• / -
• Available	
Electrical input (V/Hz)	230 V / 50Hz
Total current (A)	10
Total power (W)	2200
Main model code	1420



INFORMATION

ENERGY

SUPPLIER'S NAME MODEL IDENTIFIER → (*)

- The model information as stored in the product database can be reached by entering following website and searching for your model identifier (*) found on energy label.

<https://eprel.ec.europa.eu/>



WARNING!

- Consumption values are applicable for cases where the wireless network connection is off.

Symbols Table

Rinse	Spin+Drain	Drain	Temperature	Spin	No Spin	Tap Water (Cold)	No Water	Time Delay	Door Lock	Child Lock	On/Off	Start / Pause	Soil Level	Add Garment	Downloaded Program
Wash	Ok (End)	Cancel	AntiCrease+	Drying	Extra Dry	Cupboard Dry	Iron Dry	Timed Drying	Clean&Wear						

3 Installation



INFORMATION

- Your washing machine automatically detects the amount of laundry placed inside when selecting a program.
- While installing the product, before the first use, calibration should be done to ensure that the laundry amount is detected in the most accurate way.
- To do this, select the Drum Cleaning* program and cancel the spin function. Start the program without laundry. Wait for the program to finish, which will take about 15 minutes.

*The program name may vary depending on the model. For the appropriate program selection, review the program descriptions section.

To make the product ready for use, review the information in the user manual and make sure that the electricity, tap water supply and water drainage systems are appropriate. If they are not, call a qualified technician and plumber to have any necessary arrangements carried out.



DANGER!

- Make sure that the installation and electrical connections of the product are performed by competent persons. Manufacturer shall not be held liable for damages that may arise from procedures carried out by unauthorised persons.



DANGER!

- Your product is too heavy for one person to carry.



CAUTION!

- Prior to installation, visually check if the product has any defects on it. If so, do not have it installed. Damaged products cause risks for your safety.



PRECAUTION!

- Preparation of the location and electrical, tap water and waste water installations at the place of installation is under customer's responsibility.
- Make sure that the water inlet and discharge hoses as well as the power cable are not folded, pinched or crushed while pushing the product into its place after installation or cleaning procedures.

3.1 Appropriate installation location

- Place the product on a solid and level floor. Do not place it onto a carpet with high pile or other similar surfaces.
- Do not place the product close to the edge if the floor contains steps. Do not also place the product on a platform.
- Do not place the product on the power cable.
- Do not install the product in environments where the temperature falls below 0 °C. (See. Warnings for Drying)
- Leaving a gap at the sides of the machine is suggested to reduce vibration and noise
- In the area where this product is installed, there must not be a lockable, sliding or hinged door that will restrict the full opening of loading door.
- Operate the product in a well ventilated and dust free environment.
- Do not place heat sources such as Hobs, Irons, Ovens, etc. on the washing machine and do not use them on the product.

3.2 Removing packaging reinforcement



Tilt the machine backwards to remove the packaging reinforcement. Remove the packaging reinforcement attached to the ribbon.



DANGER!

- Your product is heavy. Remove packaging reinforcement as displayed in the figure.
- Be careful not to get your hand caught under the machine during this procedure.

3.3 Removing the transit bolts



PRECAUTION!

- Do not remove the transit bolts before removing the packaging reinforcement.
- Remove the transit bolts before operating the washing machine! Otherwise, the product will get damaged.

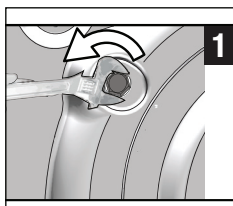

- 1 Use a tool to loosen all bolts until they rotate freely.

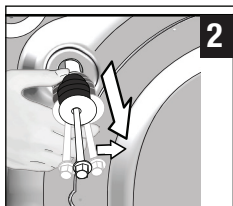

- 2 Remove the transit bolts by turning them slightly.

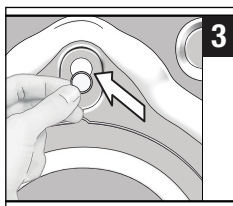

- 3 Attach the plastic covers supplied in the user manual bag into the holes on the rear panel.



INFORMATION

- Keep the transit bolts in a safe place to reuse when the product needs to be moved again in the future.
- Never move the product without the transit bolts properly fixed in place!

3.4 Connecting water supply



INFORMATION

- It is necessary to have 10 – 80 liters of water flowing from the fully open tap in one minute to have your product run smoothly. Attach a pressure reducing valve if water pressure is higher.



INFORMATION

- It is also recommended to attach a pressure reducing valve if you experience overflow from the detergent dispenser during water fill between 3.5 to 10 bars (0.35 to 1 MPa).



CAUTION!

- Models with a single water inlet should not be connected to the hot water tap. In such a case the laundry will get damaged or the product will switch to protection mode and will not operate.

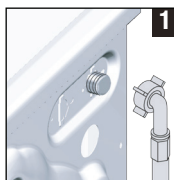

- 1 Connect the special hose supplied with the product to the water inlet on the product.



CAUTION!

- Ensure that the cold water connection is made correctly when installing the product. Otherwise, your laundry will come out hot at the end of the washing process and wear out.

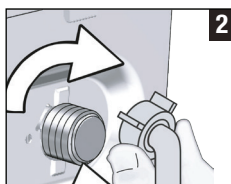

- 2 Tighten the hose nuts securely by hand. Never use a tool when tightening the nuts.

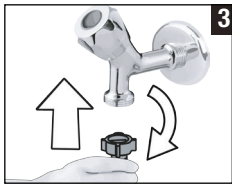

- 3** 3 Open the taps completely after making the hose connection to check for water leaks at the connection points.

If any leak occurs, turn off the tap and remove the nut. Retighten the nut carefully after checking the seal. In order to prevent the water leaks, keep the taps closed when you do not use the product.

3.5 Connecting to the drain

- Attach the end of the drain hose directly to waste water drain, sink or bathtub.



CAUTION!

- Your house will be flooded if the hose comes out of its housing during water discharge. Moreover, there is risk of scalding due to high washing temperatures! To prevent such situations and to ensure smooth water intake and discharge of the machine, fix the end of the discharge hose tightly so that it cannot displace.

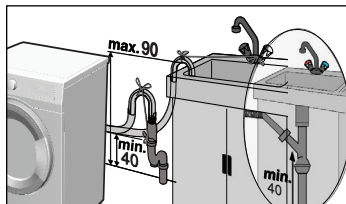
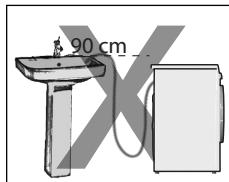
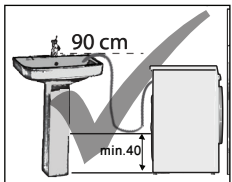

- Connect the hose to a minimum height of 40 cm and a maximum height of 90 cm.
- If the hose is run along the floor (or at less than 40 cm above it) and raised later on, water drain becomes difficult and laundry may come out extremely wet. Therefore, observe the heights described in the figure.

- To prevent flowing of dirty water back into the machine and to allow for easy discharge, do not immerse the hose end into the dirty water or do not drive it in the drain more than 15 cm. If it is too long, cut it short.
- The end of the hose should not be bent, it should not be stepped on and the hose must not be pinched between the drain and the machine.
- If the length of the hose is too short, add an original extension hose. Length of the hose may not be longer than 3.2 m. To avoid water leak failures, the connection between the extension hose and the drain hose of the product must be fitted well with an appropriate clamp as not to come off and leak.

3.6 Adjusting the feet

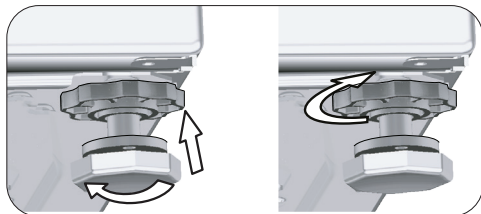
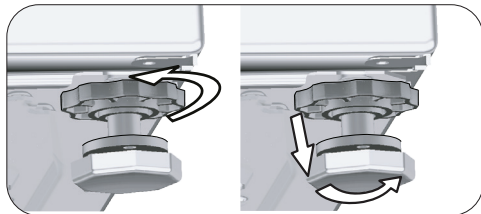

CAUTION!

- Adjust feet so that the product will be balanced in the location it will be used.
- Balance the machine by adjusting the feet.
- Check for any play by pressing the product from upper diagonal edges.
- Otherwise, the product may move from its place and cause crushing, noise and vibration problems.
- Do not use any tools to loosen the lock nuts. Otherwise, the lock nuts may get damaged.

- Loosen the lock nuts on the feet by hand.
- Adjust the feet until the product stands level and balanced.
- Tighten all lock nuts again by hand.

3.7 Electrical connection

Connect the product to a grounded outlet protected by a 16 A fuse. Our company shall not be liable for any damages that will arise when the product is used without grounding in accordance with the local regulations.

- Connection must comply with national regulations.
- The wiring for the electrical outlet circuit must be sufficient to meet the appliance requirements. Use of a Ground Fault Circuit Interrupter (GFCI) is recommended.
- Power cable plug must be within easy reach after installation.
- If the current value of the fuse or breaker in the house is less than 16 Amps, have a qualified electrician install a 16 Amp fuse.
- The voltage specified in the “Technical specifications” section must be equal to your mains voltage.



DANGER!

- Damaged power cables must be replaced by the Authorised Service Agent.

3.8 Transportation of the product

- 1 Unplug the product before transporting it.
- 2 Remove water drain and water supply connections.
- 3 Drain all water that has remained in the product. See 6.5
- 4 Install the transit bolts in reverse order of the disassembly procedure. See 3.3



DANGER!

- Your product is too heavy for one person to carry.
- Your product is heavy; two persons must carry it and extra precaution taken on stairs. If your product falls on you, it may cause injuries.



CAUTION!

- Packaging materials are dangerous to children. Keep packaging materials in a safe place away from reach of the children.



INFORMATION

- Never move the product without the transit bolts properly fixed in place!

4 Preparation

4.1 Sorting the laundry

- * Sort laundry according to type of fabric, colour, degree of soiling and the suitable water temperature.
- * Always obey the instructions given on the garment tags.

4.2 Preparing the laundry for washing

- Underwire bras and clothes with metal pieces such as buckles or buttons damage the machine. Remove the metal pieces or wash such clothes after putting them in a cotton laundry bag or cotton pillow case. Moreover, this type of clothes may overheat during the drying process and damage other clothes. Do not use the machine to dry such clothes.
- Put small size clothes such as infant's socks and nylon stockings in cotton a laundry bag or cotton pillow case.
- Place curtains in without compressing them. Remove curtain attachment items. Do not dry tulle curtains in your machine.
- Fasten zippers, sew loose buttons and mend rips and tears.
- Wash "Machine washable" or "Hand washable" labelled products only with an appropriate programme. Dry them by hanging them or laying them flat. Do not use the machine to dry such clothes.
- Do not wash colours and whites together. New, dark coloured cottons release a lot of dye. Wash them separately.
- Only use the dyes / colour changers and descaling agents which are appropriate to machine wash. Always follow the instructions on the package.



INFORMATION

- Laundry that are subjected to materials such as flour, lime dust, milk powder, etc. intensely must be shaken off before being placed into the machine. Such dusts and powders on the laundry may build up on the inner parts of the product in time and can cause damage.
- Keep laundry items made of Angora wool in a plastic bag in the freezer for a few hours before washing. This can reduce piling.
- Wash trousers and delicate laundry turned inside out.
- Tough stains must be treated properly before washing.
- Take out all substances in the pockets such as coins, pens and paper clips, and turn pockets inside out and brush if possible. Such objects may damage the product or cause noise problem.

4.3 Tips for energy and water saving

Following information will help you use the product in an ecological and energy/water-efficient manner.

- Operate the product in the highest load capacity allowed for the programme you have selected, but do not overload. See, "Programme and consumption table".
- Observe the temperature instructions on the detergent packaging.
- Wash slightly soiled laundry at low temperatures.
- Use faster programmes for small quantities of lightly soiled laundry.
- Do not use prewash and high temperatures for laundry that is not heavily soiled or stained.
- If you plan to dry your laundry in a dryer, select the highest spin speed recommended during washing process.
- Do not use more detergent than the recommended on the detergent packaging.

4.4 First use



Before starting to use the product make sure that all preparations are made in accordance with the "Important safety and environment instructions" and the instructions in the "Installation" section.

To prepare the product for washing laundry, perform first operation in Drum Cleaning programme. If this programme is not available on your machine, apply the method described in section 6.2.



INFORMATION

- Use an anti-limescale agent suitable for washing machines.
- Some water has remained in the product due to the quality control processes in the production. It is not harmful for the product.

4.5 Correct load capacity

The maximum load capacity depends on the type of laundry, the degree of soiling and the selected washing programme. The product automatically adjusts the water amount according to the weight of the laundry put inside it.



CAUTION!

- Follow the information in the "Programme and consumption table". When overloaded, machine's washing performance will drop. Moreover, noise and vibration problems may occur. For a good drying performance, do not load the machine with more laundry than recommended.

Laundry type	Weight (g)	Laundry type	Weight (g)
Bathrobe	1200	Hand towel	100
Fabric napkin	100	Nightgown	200
Bed sheet	700	Underclothing	100
Bed sheet	500	Men's work shirts	600
Pillowcase	200	Men's shirt	200
Tablecloth	250	Men's pyjamas	500
Towel	200	Blouses	100

4.6 Loading the laundry

1. Open the loading door.
2. Place the laundry loosely in the product.
3. Push the loading door to close it until you hear a locking sound. Ensure that no items are caught in the door.



INFORMATION

- The loading door is locked while a programme is running. The door lock will open immediately after the washing programme has ended. If the inner part of the machine is too hot at the end of the programme, the loading door will not open until the temperature drops. If the door does not open, apply the solutions provided for "Loading Door Cannot be Opened." error in the Troubleshooting section.



CAUTION!

- If the laundry is misplaced, noise and vibration problems may occur in the machine.

4.7 Using detergent and softener



INFORMATION

- When using detergent, softener, starch, fabric dye, bleach or limescale remover, read the manufacturer's instructions on the package carefully and follow the suggested dosage values. Use measuring cup if any.

4.7.1 Detergent drawer

The detergent drawer is composed of three compartments:

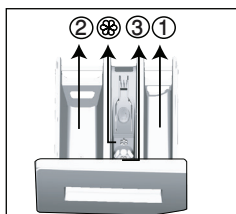

- (1) for prewash
- (2) for main wash
- (3) for softener
- (⊗) in addition, there is a siphon part in the softener compartment.

4.7.2 Detergent, softener and other cleaning agents

- Add detergent and softener before starting the washing programme.
- Never leave the detergent drawer open while the washing programme is running!
- When using a programme without prewash, do not put liquid detergent into the prewash compartment (compartment no. "1").
- If you are using a program with prewash, start the machine after adding powder detergent to the prewash and main wash

- compartments (compartments 1 and 2).
- Do not select a programme with prewash if you are using a detergent bag or dispensing ball. Place the detergent bag or the dispensing ball directly among the laundry in the machine. Remove them after drying.
- If you are using liquid detergent, do not forget to place the liquid detergent container into the main wash compartment (compartment no. 2).
- When the machine is in Drying step, do not add any washing chemicals (Liquid detergent, Softener, etc.).

4.7.3 Choosing the detergent type

Detergent type to be used depends on the washing programme, fabric type and colour.

- Use different detergents for coloured and white laundry.
- Wash your delicate clothes only with special detergents (liquid detergent, wool shampoo, etc.) intended solely for delicate clothes and at suggested programmes.
- When washing dark coloured clothes and quilts, it is recommended to use liquid detergent.
- Wash woollens at suggested programme with special detergent made specifically for woollens
- Please review the programme descriptions part for suggested programme for different textiles.
- All recommendations about detergents are valid for selectable temperature range of programmes.

	CAUTION!
<ul style="list-style-type: none"> Use only detergents manufactured specifically for washing machines. Do not use soap powder. 	

4.7.4 Adjusting the amount of detergent

The amount of washing detergent to be used depends on the amount of laundry, the degree of soiling and water hardness.

- Do not use amounts exceeding the dosage quantities recommended on the detergent package to avoid problems of excessive foam, poor rinsing, financial savings and finally, environmental protection.
- Use less detergent for small loads, lightly soiled clothes and short duration programmes, especially in soft water areas.

4.7.5 Using softeners

Pour the softener into the softener compartment of the detergent drawer.

- Do not exceed the (>max<) level marking in the softener compartment.
- If the softener has lost its fluidity or if it is concentrated, dilute it with water before putting it in the detergent drawer.

4.7.6 Using liquid detergents

4.7.6.1 If the product contains a liquid detergent container

- Place the liquid detergent container in compartment no. "2".
- If the liquid detergent has lost its fluidity, dilute it with water before putting in the compartment.

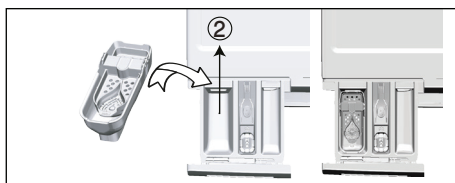

4.7.6.2 If the product is equipped with a liquid detergent apparatus:

- When you want to use liquid detergent, press on the point shown to rotate the apparatus. The part that falls off will function as a barrier for the liquid detergent.
- If required, clean the apparatus with water when it is in place or by removing it.
- If you will use powder detergent, the apparatus must be secured at top position. The fan that you would see in this position will mix the powder detergent and help it to dissolve.

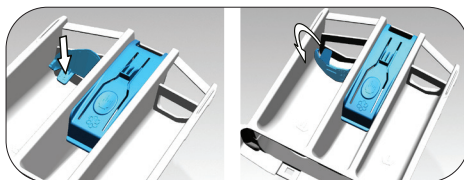

4.7.6.3 If the product does not contain a liquid detergent container

- Do not use liquid detergent for the prewash in a programme with prewash.
- Liquid detergent stains your clothes when used with Delayed Start function. If you are going to use the Delayed Start function, do not use liquid detergent.

4.7.7 Using gel and tablet detergent

- If the gel detergent thickness is fluidal and your machine does not contain a special liquid detergent container, put the gel detergent into the main wash detergent compartment during first water intake. If your machine contains a liquid detergent container, fill the detergent into this container before starting the programme.
- If the gel detergent thickness is not fluidal or in the shape of capsule liquid tablet, put it directly into the drum before washing.
- Put tablet detergents into the main wash compartment (compartment no. "2") or directly into the drum before washing.



INFORMATION

- Tablet detergents may leave residues in the detergent compartment. If you encounter such residues, place the tablet detergent between the laundry, close to the lower part of the drum in future washings.
- Use the tablet or gel detergent without selecting the prewash function.



INFORMATION

- Before drying, remember to remove objects such as the plastic detergent container from the drum.

4.7.8 Using laundry starch

- Add liquid starch, powder starch or the fabric dye into the softener compartment.
- Do not use softener and starch together in a washing cycle.
- Wipe the inside of the machine with a damp and clean cloth after using starch.

4.7.9 Using bleach

- Select a programme with prewash and add the bleach at the beginning of the prewash. Do not put detergent in the prewash compartment. Alternatively, select a programme with an extra drying step, add the bleach to the empty detergent compartment and once you see the rinsing step on the display for the first time, add 1 glass of water into the same compartment.
- Do not use bleach and detergent by mixing them.
- Use just a little amount (approximately 50 ml) of bleach and rinse the clothes very well as it causes skin irritation. Do not pour the bleach onto the laundry and do not use it with the coloured items.
- When using oxygen-based bleaches, select a programme that washes the laundry at a low temperature.
- You can use oxygen-based bleaches together with the detergent. However, if it has a different consistency, first add the detergent into the detergent compartment no "2" and wait for the machine to take in the detergent together with water. While the product continues taking in water, add bleach in the same compartment.

4.7.10 Using limescale remover

- When required, use limescale removers manufactured specifically for washing machines only.

4.8 Tips for efficient washing

		Clothes			
		Light Colours and Whites	Colours	Black/Dark Colours	Delicates/Woollens/Silks
		(Recommended temperature range based on soiling level: 40-90°C)	(Recommended temperature range based on soiling level: cold -40°C)	(Recommended temperature range based on soiling level: cold -40°C)	(Recommended temperature range based on soiling level: cold -30°C)
Soiling Level	Heavily Soiled (difficult stains such as grass, coffee, fruits and blood.)	It may be necessary to pre-treat the stains or perform prewash. Powder and liquid detergents recommended for whites can be used at dosages recommended for heavily soiled clothes. It is recommended to use powder detergents to clean clay and soil stains and the stains that are sensitive to bleaches.	Powder and liquid detergents recommended for coloured laundry can be used at dosages recommended for heavily soiled clothes. It is recommended to use powder detergents to clean clay and soil stains and the stains that are sensitive to bleaches. Detergents which do not contain bleach should be used.	Liquid detergents suitable for colours and dark colours can be used at dosages recommended for heavily soiled clothes.	Prefer liquid detergents produced for delicate clothes. Woollen and silk clothes must be washed with special woollen detergents.
	Normally Soiled (For example, stains caused by body on collars and cuffs)	Powder and liquid detergents recommended for whites can be used at dosages recommended for normally soiled clothes.	Powder and liquid detergents recommended for colours can be used at dosages recommended for normally soiled clothes. Detergents which do not contain bleach should be used.	Liquid detergents suitable for colours and dark colours can be used at dosages recommended for normally soiled clothes.	Prefer liquid detergents produced for delicate clothes. Woollen and silk clothes must be washed with special woollen detergents.
	Lightly Soiled (No visible stains exist.)	Powder and liquid detergents recommended for whites can be used at dosages recommended for lightly soiled clothes.	Powder and liquid detergents recommended for colours can be used at dosages recommended for lightly soiled clothes. Detergents which do not contain bleach should be used.	Liquid detergents suitable for colours and dark colours can be used at dosages recommended for lightly soiled clothes.	Prefer liquid detergents produced for delicate clothes. Woollen and silk clothes must be washed with special woollen detergents.

4.9 Tips for correct drying

		Programmes				
		Cottons Drying	Synthetics Drying	Babyprotect +	Washing and Drying	Wash&Wear
Types of Clothes	Durable Clothes with Cotton-Content	Sheet, bedding, baby clothes, t-shirts, sweatshirts, durable knit clothing, jeans, canvas trousers, shirts, cotton socks etc.	Not recommended!	Washes and dries respectively! Sheet, bedding, baby clothes, t-shirts, sweatshirts, durable knit clothing, jeans, canvas trousers, shirts, cotton socks etc.	Washes and dries respectively! Sheet, bedding, baby clothes, t-shirts, sweatshirts, durable knit clothing, jeans, canvas trousers, shirts, cotton socks etc.	Stainless clothes that has been worn for a short time such as shirts, t-shirts, sweatshirts A very small amount of laundry must be loaded.
	Synthetics Clothes (Polyester, nylon, etc.)	Not recommended!	It is recommended for the polyester, nylon, polyacetate, acrylic-content clothes. Drying is not recommended for the viscose-content clothes. Drying explanations in the maintenance label should be taken into account.	It is recommended for polyester, nylon, polyacetate, acrylic content clothes at low temperatures, taking into account the washing and drying warnings on the care label.	It is recommended for polyester, nylon, polyacetate, acrylic content clothes at low temperatures, taking into account the washing and drying warnings on the care label.	Lightly soiled and stainless shirts, t-shirts and synthetic-content clothes. A very small amount of laundry should be loaded.
	Delicate (Silk, Woolens, Cashmere, Angora wool, etc. content) Clothes	Not recommended!	Not recommended!	Not recommended!	Not recommended!	Not recommended!
	Bulky laundry such as blankets, coats, curtains etc.	Not recommended! It is not appropriate to dry bulky laundry in the washer. Dry them by hanging them or laying them flat.	Not recommended! It is not appropriate to dry bulky laundry in the washer. Dry them by hanging them or laying them flat.	Not recommended! It is not appropriate to dry bulky laundry in the washer. Dry them by hanging them or laying them flat.	Not recommended! It is not appropriate to dry bulky laundry in the washer. Dry them by hanging them or laying them flat.	Not recommended! It is not appropriate to dry bulky laundry in the washer. Dry them by hanging them or laying them flat.

4.10 Displayed Programme Time

You can see the programme duration on the display of your machine while selecting a programme. Depending on the amount of laundry you have loaded into your machine, foaming, unbalanced load conditions, fluctuations in power supply, water pressure and programme settings, the programme duration is automatically adjusted while the programme is running.

SPECIAL CASE: At programme start of Cottons and Cotton Eco programmes, display shows the duration of half load, which is the most common use case. After programme starts, in 20-25 minutes actual load is detected by the machine. And if the detected load is higher than half load; washing programme will be adjusted accordingly and programme duration increased automatically. You may follow this change on the display.

5 Operating the product

5.1 Control panel

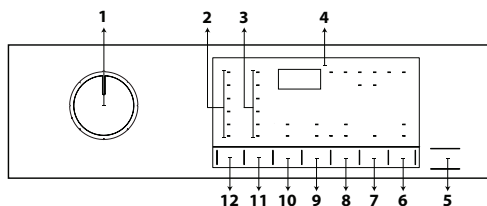

- 1 - Programme selection knob
- 2 - Temperature level lights
- 3 - Spin speed level lights
- 4 - Display
- 5 - Start/Pause button
- 6 - Remote Control button
- 7 - End Time Adjustment button
- 8 - Drying Level Adjustment Button
- 9 - Auxiliary function button 2
- 10 - Auxiliary function button 1
- 11 - Spin speed adjustment button
- 12 - Temperature adjustment button

5.2 Display Symbols

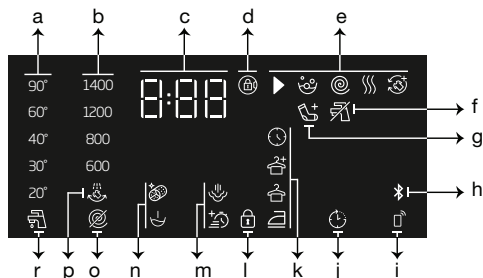

- a - Temperature indicator
- b - Spin speed indicator
- c - Duration information
- d - Door lock engaged symbol
- e - Programme follow-up indicator
- f - No water indicator
- g - Add laundry indicator
- h - Bluetooth connection indicator
- i - Remote Control indicator
- j - Delayed Start enabled indicator
- k - Drying level indicator
- l - Child lock enabled symbol
- m - Auxiliary function indicators 2
- n - Auxiliary function indicators 1
- o - No spin indicator
- p - Rinse hold indicator
- r - Cold water indicator

5.3 Preparing the Machine

1. Check if the hoses are connected tightly.
2. Plug in your machine.
3. Turn the tap on completely.
4. Place the laundry in the machine.
5. Add detergent and fabric softener.

5.4 Selecting a washing programme

1. In accordance with the "Programme and consumption table", select a suitable programme for the amount and soiling level of the laundry.
2. Select the desired programme with the **Programme Selection** knob.



INFORMATION

- Programmes are limited to the highest spin speed appropriate for that particular type of fabric.
- When selecting a programme, always consider the type of fabric, colour, soiling level and permissible water temperature.

5.5 Washing programmes

Depending on the type of fabric, use the following main programmes.



INFORMATION

- After selecting a washing programme suitable for your laundry, you can press the Drying button to set the machine to perform drying after the washing programme. Each time you press the button, info line shows at which step the drying process will take place and the relevant symbol will turn on. If you want, you can keep pressing the button to perform drying for the maximum period allowed.
- The symbols shown on the display are schematic and may not match the product exactly.
- When you will perform washing and drying by using the Drying function of your machine, load maximum 5 kg of laundry into the machine. If you exceed the capacity of the machine, your laundry will not dry and the machine will work longer, which will result in more energy consumption.

• Cotone (Cottons)

You can wash your durable cotton laundry (sheets, bedlinen, towels, bathrobes, underwear etc.) in this programme. When you press the quick wash function key, programme duration becomes notably shorter but effective washing is ensured thanks to intense washing movements. If the quick wash function is not selected, superior washing and rinsing performance is ensured for your heavily soiled laundry.



INFORMATION

- You can dry your laundry without any interruption right after the washing programme (it is possible to perform automatic or scheduled drying after the washing cycle). For this, you must also select the Drying function before starting the washing programme.
- According to the drying selections you will add to the washing programmes, you can see when the programme will end on the display of the machine.
- If you don't want drying to take place after the programme you have selected, press and hold the Drying auxiliary function button until the Drying light turns off.

• Sintetici (Synthetics)

You can use this programme to wash t-shirts, synthetic/cotton mix fabrics etc. Programme duration is notably shorter and efficient washing performance is ensured. If the quick wash function is not selected, superior washing and rinsing performance is ensured for your heavily soiled laundry.



INFORMATION

- You can dry your laundry without any interruption right after the washing programme (it is possible to perform automatic or scheduled drying after the washing cycle). For this, you must also select the Drying function before starting the washing programme.
- According to the drying selections you will add to the washing programmes, you can see when the programme will end on the display of the machine.
- If you don't want drying to take place after the programme you have selected, press and hold the Drying auxiliary function button until the Drying light turns off.

• Lana / Lavaggio a Mano (Woolens / Hand Wash)

Use this programme to wash your woollen clothes. Select the appropriate temperature complying with the tag of your clothes. Your laundry will be washed with very delicate movements to avoid any damage.



INFORMATION

- The drying function cannot be selected for the washing programme designed for woollen laundry.

• Eco 40-60

The eco 40-60 programme is able to clean normally soiled cotton laundry declared to be washable at 40 °C or 60 °C, together in the same cycle, and that this programme is used to assess the compliance with the EU ecodesign legislation. Although it washes longer than all other programmes, it provides high energy and water savings. Actual water temperature may be different from the stated wash temperature. When you load the machine with less laundry (e.g. ½ capacity or less), periods in programme stages may automatically get shorter. In this case, energy and water consumption will decrease. Cupboard drying function should be selected with eco 40-60 to perform wash and dry cycle to assess the compliance with the EU ecodesign legislation.

The wash and dry cycle is able to clean normally soiled cotton laundry declared to be washable at 40 °C or 60 °C, together in the same cycle, and to dry it in such a way that it can be immediately stored in a cupboard.



INFORMATION

- You can dry your laundry without any interruption right after the washing programme (it is possible to perform automatic or scheduled drying after the washing cycle). For this, you must also select the Drying function before starting the washing programme.
- According to the drying selections you will add to the washing programmes, you can see when the programme will end on the display of the machine.
- If you don't want drying to take place after the programme you have selected, press and hold the Drying auxiliary function button until the Drying light turns off.

• Xpress / Super Xpress

Use this programme to wash your lightly soiled cotton clothes in a short time. The programme duration can be reduced down to 14 minutes when the quick wash function is selected. When the quick wash function is selected, maximum 2 (two) kg of laundry must be washed.



INFORMATION

- You can dry your laundry without any interruption right after the washing programme (it is possible to perform automatic or scheduled drying after the washing cycle). For this, you must also select the Drying function before starting the washing programme.
- According to the drying selections you will add to the washing programmes, you can see when the programme will end on the display of the machine.
- If you don't want drying to take place after the programme you have selected, press and hold the Drying auxiliary function button until the Drying light turns off.

• Camicie (Shirts)

This programme is used to wash the shirts made from cotton, synthetic and synthetic blended fabrics altogether. It reduces wrinkles. Steam is applied at the end of the programme to help the wrinkle reducing function. The special spin profile and steam applied at the end of the programme reduce the wrinkles on your shirts. When the quick wash function is selected, the Pre-treatment algorithm is executed.

- Apply the pre-treatment chemical on your garments directly or add it together with detergent when the machine starts to take water from the main washing compartment. Thus, you can obtain the same performance as you obtain with normal washing in a much shorter period of time. Usage life of your shirts increases.



INFORMATION

- You can dry your laundry without any interruption right after the washing programme (it is possible to perform automatic or scheduled drying after the washing cycle). For this, you must also select the Drying function before starting the washing programme.
- According to the drying selections you will add to the washing programmes, you can see when the programme will end on the display of the machine.
- If you don't want drying to take place after the programme you have selected, press and hold the Drying auxiliary function button until the Drying light turns off.

• Piumino (Down Wear)

Use this programme to wash down coats, vests, jackets etc. that bear a "machine-washable" tag. Thanks to special spin profiles, it is ensured that water reaches the air gaps between feathers.

• Programmi da App (Downloaded Program)

This is a special programme that allows you to download different programmes when you want to. At the start, there is a programme you will see with the HomeWhiz application as default. However, you can use the HomeWhiz application to select a programme from the predefined programme settings, and then change it.



INFORMATION

- If you wish to use the HomeWhiz and Remote Control functions, you need to select Download Programme. Please see the section HomeWhiz and Remote Control Function for more details.

• Mix

You can use this programme to wash cottons and synthetics together without the need to sort them.



INFORMATION

- You can dry your laundry without any interruption right after the washing programme (it is possible to perform automatic or scheduled drying after the washing cycle). For this, you must also select the Drying function before starting the washing programme.
- According to the drying selections you will add to the washing programmes, you can see when the programme will end on the display of the machine.
- If you don't want drying to take place after the programme you have selected, press and hold the Drying auxiliary function button until the Drying light turns off.

• Outdoor / Sports

Use this programme to wash outdoor/sports clothes that contain cotton/synthetic mix, as well as waterproof cloths like gore-tex. This programme washes your laundry delicately thanks to its special turning movements.



INFORMATION

- You can dry your laundry without any interruption right after the washing programme (it is possible to perform automatic or scheduled drying after the washing cycle). For this, you must also select the Drying function before starting the washing programme.
- According to the drying selections you will add to the washing programmes, you can see when the programme will end on the display of the machine.
- If you don't want drying to take place after the programme you have selected, press and hold the Drying auxiliary function button until the Drying light turns off.

• Dark Care /Jeans

Use this programme to preserve the colour of your dark-coloured clothes and jeans. This programme provides high efficiency in washing, thanks to a special drum movement, even at low temperatures. It is recommended to use liquid detergent or woollen shampoo for dark coloured laundry. Do not wash your delicate clothes that contain wool etc. in this programme.



INFORMATION

- You can dry your laundry without any interruption right after the washing programme (it is possible to perform automatic or scheduled drying after the washing cycle). For this, you must also select the Drying function before starting the washing programme.
- According to the drying selections you will add to the washing programmes, you can see when the programme will end on the display of the machine.
- If you don't want drying to take place after the programme you have selected, press and hold the Drying auxiliary function button until the Drying light turns off.

• Lingerie

You can use this programme to wash delicate garments that are suitable for hand wash and delicate women's underwear. Small amount of garments must be washed in a washing net. Hooks, buttons etc. must be done up and zips must be zipped up.

• Towel

Use this programme to wash durable cotton laundry such as towels. Load the towels into the machine paying attention to place them in a way that they will not contact the bellow or the glass.

• Risciacquo (Rinse)

Use when you want to rinse or starch separately.

• Centrifuga+Scarico (Spin+Pump)

Use this programme to drain the water in the machine.

5.6 Temperature selection

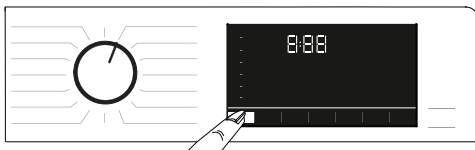

Whenever a new programme is selected, the temperature recommended for that programme appears on the temperature indicator. It is possible that the recommended temperature is not the highest value that can be selected for the relevant programme. Press the **Temperature Adjustment** key to change the temperature.



INFORMATION

- Temperature Adjustment button works only backwards. For example, if the display shows 40°C but you want to select 60°C, you will need to press the button for a few times until you reach 60°C from 40°C.



INFORMATION

- If you scroll to Cold Wash option and press the Temperature Adjustment button again, the recommended maximum temperature for the selected programme will appear on the display. To decrease the temperature, press the Temperature Adjustment button again.

Finally, the Cold light will turn on, indicating cold wash.

You can also change the temperature after the washing cycle has started. You can select the desired temperature after the washing programme has started. However, you need to do this before the heating step starts.

5.7 Spin speed selection

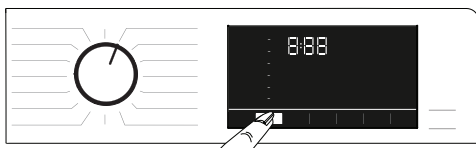

Whenever a new programme is selected, the spin speed recommended for the selected programme appears on the **Spin Speed** indicator.



INFORMATION

- It is possible that the recommended spin speed is not the highest value that can be selected for the relevant programme.

Press the **Spin Speed Adjustment** button to change the spin speed. Spin speed decreases gradually.

Then, depending on the model of the product, "Rinse Hold" and "No Spin" options appear on the display.



INFORMATION

- Spin Speed Adjustment button works only backwards. For example, if the display shows 800 rpm but you want to select 1000 rpm, you will need to press the button for a few times until you reach 1000 rpm from 800 rpm.

5.7.1 If you want to spin your laundry after the Rinse Hold function:

- Adjust the **Spin Speed**.
- Press the **Start/Pause** button. Programme will resume. The machine will drain the water and spin the clothes.

If you want to drain the water at the end of the programme without spinning, you can use the **No Spin** function.



INFORMATION

- If you press the Spin Speed adjustment button in programmes where the spin speed is not allowed, the spin speed setting will not change and you will hear a warning.

You can also change the spin speed after the washing cycle has started. After the washing cycle has ended, you can press the spin speed adjustment button to select a spin speed. However, you need to do this before the spinning step begins.

5.7.2 Auxiliary function selection for drying

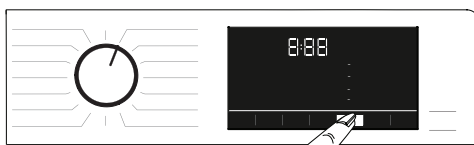

When you select a new washing programme, press the Auxiliary Function Selection button to set the drying option suitable for this programme.



INFORMATION

- If you press the Drying auxiliary function button in programmes where the drying step is not allowed, the drying light will not change and you will hear a warning.



INFORMATION

- Only for drying programmes, press the Auxiliary Function Selection button to set the suitable drying option.

5.8 Drying programmes



CAUTION!

- During the drying programme, the machine automatically removes the lints coming from the clothes. The machine uses water in the drying step. For this reason, water tap of the machine should be open also in the drying programmes.
- When you select a new washing programme, press the Auxiliary Function Selection button to set the drying option suitable for this programme.



INFORMATION

- There is a spinning step in the drying programmes. Your machine performs this process in order to shorten the drying time. While the drying programme is selected, the spin speed setting is within the Maximum spin speed range.
- If you press the Drying auxiliary function button in programmes where the drying step is not allowed, the drying light will not change and you will hear a warning.
- Only for drying programmes, press the Auxiliary Function Selection button to set the suitable drying option.
- In case of water outage, washing or drying cannot be performed.

• Asciugatura Sintetici (Synthetic Dry)

Use this programme to dry synthetic clothes with dry weight up to 3 kg. You can perform only drying in this programme.



INFORMATION

- For dry weight of laundry, see Section 4, Step 4.5.

• Asciugatura Cotone (Cotton Dry)

Use this programme to dry cotton clothes with dry weight up to 5 kg. You can perform only drying in this programme.



INFORMATION

- If you are going to dry laundry that comprises only towels and bathrobes, the maximum amount of laundry that can be loaded is 4 kg.
- For dry weight of laundry, see Section 4, Step 4.5.

5.9 Washing and drying programmes



CAUTION!

- During the drying programme, the machine automatically removes the lints coming from the clothes. The machine uses water in the drying step. For this reason, water tap of the machine should be open also in the drying programmes.

• 5 kg Lava e Asciuga (5 Kg Wash & Dry)

Use this programme to wash cotton laundry of up to 5 kg and to dry right after the washing programme without making any other selection.



INFORMATION

- When this programme is selected, the external Drying auxiliary function cannot be selected.

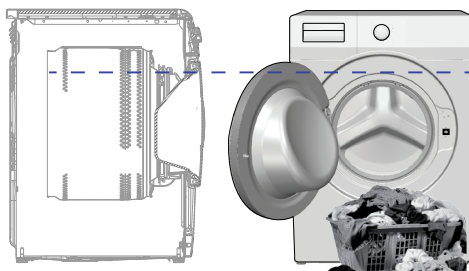

In the 5 kg Washing and 5 kg Drying programme, it is recommended to load the machine up to the level shown above for ideal drying conditions (you can see the level arrow if you open the loading door).

• Wash & Wear

Use this programme to wash 0.5 kg of laundry (2 shirts) in 40 minutes or 1 kg of laundry (5 shirts) in 60 minutes.



INFORMATION

- The Wash&Wear programme is designed to quickly wash and dry daily clothes that have been worn for a short time and are not heavily soiled. This programme is suitable for thin-textured clothes that dry quickly (shirts, t-shirts).
- Other drying options or programmes should be used for thick texture laundry that takes long to dry.

• Hygiene+ Lava e Asciuga (Hygiene+ Wash & Dry)

Applying a steam step at the beginning of the programme allows to soften the dirt easily. Use this programme to wash and quickly dry laundry (up to 2 kg) that requires anti-allergic and hygienic washing (cottons such as baby clothes, sheets and underwear).



INFORMATION

- The Hygiene programme has been tested and approved by the “British Allergy Foundation” (Allergy UK) based in the United Kingdom.

5.10 Programme and consumption table (for washing)

EN					Auxiliary functions					
Programme (°C)	Max. Load (kg)	Water Consumption (l)	Energy Consumption (kWh)	Max. Speed	Steam	Rapido	Prelavaggio	Anti-Crease+	Asciugatura	Selectable temperature range °C
Cotone	90	8	90	2,50	1400	•	•	•	•	Cold - 90
	60	8	90	1,80	1400	•	•	•	•	Cold - 90
	40	8	88	0,97	1400	•	•	•	•	Cold - 90
Eco 40-60	40 ***	8	54	0,955	1400				•	40 - 60
	40 ***	4	35	0,550	1400				•	40 - 60
	40 ***	2	28	0,320	1400				•	40 - 60
Eco 40-60 + Cupboard Dry	40 ***	5	61	3,215	1400				•	40 - 60
	40 ***	2,5	42	1,780	1400				•	40 - 60
Sintetici	60	3	60	1,35	1200	•	•	•	•	Cold - 60
	40	3	58	0,85	1200	•	•	•	•	Cold - 60
Xpress / Super Xpress	90	8	68	2,20	1400	•	•	•	•	Cold - 90
	60	8	68	1,20	1400	•	•	•	•	Cold - 90
	30	8	68	0,20	1400	•	•	•	•	Cold - 90
Xpress / Super Xpress + Rapido	30	2	40	0,15	1400	•	•	•	•	Cold - 90
Lana / Lavaggio a Mano	40	1,5	55	0,50	1200					Cold - 40
Piumino	60	2	75	1,30	800	•				Cold - 60
Camicie	60	3	63	1,23	800	•	•	•	•	Cold - 60
Drum Clean+	90	-	76	2,60	600	*			*	90
Programmi da App *****										
Mix	40	3,5	70	0,90	800	•	•	•	•	Cold - 40
Outdoor / Sports	40	3,5	52	0,65	1200			•	•	Cold - 40
Dark Care / Jeans	40	3,5	70	0,85	1200	•	•	•	•	Cold - 40
Towel	60	1	86	1,20	800	•				Cold - 60
Lingerie	30	1	65	0,56	600					Cold - 30

- : Selectable.
- * : Automatically selected, cannot be cancelled.

***: Eco 40-60 with 40 °C temperature selection is the washing performance test program in accordance with EN 62512 and energy label test program in accordance with Commission Delegated Regulation (EU) 2019/2014
Eco 40-60 with 40 °C temperature and cup board dry selection is the wash and dry cycle test program in accordance with EN 62512 and energy label test program in accordance with Commission Delegated Regulation (EU) 2019/2014
****: These programmes can be used with the HomeWhiz application. Energy consumption may increase with connection.

- : See the programme description for maximum load.



INFORMATION

- Please read installation section of the manual before first use.
- The auxiliary functions in the table may vary according to the model of your machine.
- Water and power consumption may vary subject to the changes in water pressure, water hardness and water temperature, ambient temperature, type and amount of laundry, selection of auxiliary functions and spin speed, and changes in the mains voltage.
- When selecting a programme, you can see the washing duration on the display of your machine. Depending on the amount of laundry you have loaded into the machine, there might be a difference of 1 to 1.5 hours between the duration shown on the display and the actual duration of the washing programme. The duration will be corrected automatically right after the washing programme has started.
- "Auxiliary function selection modes can be changed by the manufacturing company. New selection models may be added, or the existing ones may be removed."
- "Spin speed of your machine may vary depending on the programme; the spin speed cannot exceed the maximum spin speed of your machine."
- Always select the lowest appropriate temperature. The most efficient programmes in terms of energy consumption are generally those that perform at lower temperatures and longer duration.
- Noise and remaining moisture content are influenced by the spinning speed: the higher the spinning speed in the spinning phase, the higher the noise and the lower the remaining moisture content.

Programme and consumption table (for drying)

EN						Auxiliary functions					Drying level				
						Max. Speed	Steam	Prelavaggio	Rapido	Anti-Crease+	Asciugatura	Extra Dry	Cupboard Dry	Iron Dry	Time based drying - minutes
Asciugatura Cotone	-	5	45	3,20	1400				•	*	•	•	•	•	-
Asciugatura Sintetici	-	3	30	2,10	-				•	*		•	•	•	-
Hygiene+ Lava e Asciuga	60	2	120	3,80	1400	*			•	*	•	•	•	•	90-30
5kg Lava e Asciuga	60	5	94	5,00	1400				•	*	•	•	•	•	60-Cold
Wash & Wear	30	0,5	35	0,60	1200				•	*				•	30-Cold
Wash & Wear	30	1	44	1,00	1200				•	*				•	30-Cold

Consumption Values (EN)								
	Temperature Selection (°C)	Spin Speed (rpm)	Capacity (kg)	Programme Duration (hh:mm)	Energy Consumption (kWh/cycle)	Water Consumption (L/cycle)	Laundry Temperature (°C)	Remaining Moisture Content (%)
Eco 40-60	40	1400	8	03:38	0,955	54	40	53
	40	1400	4	02:47	0,550	35	32	53
	40	1400	2	02:47	0,320	28	23	53
Cotone	20	1400	8	03:40	0,600	93	20	53
	60	1400	8	03:40	1,800	90	60	53
Sintetici	40	1200	3	02:25	0,850	58	40	40
Xpress / Super Xpress	30	1400	8	00:28	0,200	68	23	62
Eco 40-60 + Cupboard Dry	40	1400	5	07:55	3,215	61	25	53
	40	1400	2,5	05:50	1,780	42	24	53

The consumption values given for programmes other than the Eco 40-60 programme for washing and drying online are only indicative.

5.11 Auxiliary function selection

Select the desired auxiliary functions before starting the programme. When a programme is selected, lights of the auxiliary functions that can be selected together with that programme will turn on.

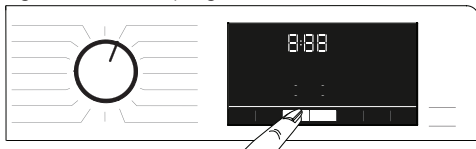

INFORMATION

- Lights of the auxiliary functions that cannot be selected together with the selected programme will not turn on. If you press the buttons of these auxiliary functions, you will hear a warning and selection will be disabled.

If the washing programme has reached a point where an auxiliary function cannot be selected, you cannot select any function.



INFORMATION

- Some functions cannot be selected together. If a second auxiliary function conflicting with the first one is selected before starting the machine, the function selected first will be cancelled and the second auxiliary function selection will remain active.
- An auxiliary function which is not compatible with the programme cannot be selected. (See "Programme and consumption table")
- Some programmes have auxiliary functions that must run together with the selected programme. These functions cannot be cancelled. The light of the relevant auxiliary function is already on.



INFORMATION

- If the selected wetness level (Iron Dry, Cupboard Dry, Cupboard Extra Dry) cannot be reached at the end of the drying programme, your machine will automatically extend the programme duration. The programme will take longer.
- If Timed Drying is selected, the programme will end at the end of the drying time even if the laundry is not dry.
- If, during the drying programme, the selected wetness level (Iron Dry, Cupboard Dry, Cupboard Extra Dry) is reached or extra dryness is detected in the timed drying options, the programme will take shorter. The time decrease will be shown on the display.

5.11.1 Auxiliary Functions

• Prelavaggio (Prewash)

A Prewash is required only for heavily soiled laundry. Not using the Prewash will save energy, water, detergent and time.

• Rapido (Fast+)

You can press the Quick Wash button to shorten the programme time after selecting the programme. For some programmes, the time can be shortened by over 50%. Still, for medium and lightly soiled laundry, you will get the same washing results in a shorter time.

Although it depends on the programme, pressing the Quick Wash button once will shorten the programme time down to a certain level. Press the same button for the second time to drop the time to the minimum level.

For better washing results, do not use the Quick Wash button for heavily soiled laundry.

For medium and lightly soiled laundry, use the Quick Wash button to shorten the programme time.

• Remote Control

You can use this auxiliary function button to connect your product to smart devices. For detailed information, see HomeWhiz and the Remote Control Function.

• Custom Programme

This auxiliary function can be used for Cottons and Synthetics programmes only with the HomeWhiz application. When this auxiliary function is enabled, you can add up to 4 additional rinse steps to the programme. You can select and use some auxiliary functions even though they are not found on your product. You can increase and decrease the time of the Cottons and Synthetics programmes within a safe range.

• Asciugatura (Drying)

This function dries your laundry after the washing cycle. Please see the programme table for programmes that can be used with this function.

5.11.2 Functions/Programmes Selected by Pressing the Function Buttons for 3 Seconds

• Drum Clean+ 3"

To select this programme, press and hold the auxiliary function button 1 for 3 seconds. Use regularly (once in every 1-2 months) to clean the drum and provide the required hygiene. Before the programme, it applies steam to soften residues in the drum. Operate the programme while the machine is completely empty. To obtain better results, put powder lime-scale remover for washing machines into the detergent compartment no. "2". This programme contains a drying step that runs after the drum cleaning step to dry the inside of the machine.



INFORMATION

- This is not a washing programme. It is a maintenance programme.
- Do not run this programme when there are any objects in the machine. If you try to do so, the machine will automatically detect that there is load inside and abort the programme.

• Anti Crease+ 3"

If you press and hold the spin selection button for 3 seconds, this function will be selected and the programme follow-up light of the relevant programme will turn on. When this function is selected, it aerates the laundry for up to 8 hours at the end of the programme to prevent creasing.

You can cancel the programme and take your laundry out at any time during the 8-hour duration. Press the function selection key or the machine on/off key to cancel the function. The programme follow-up light will remain on until the function is cancelled or the step is complete. If the function cannot be cancelled, it will be active in the subsequent washing cycles as well.

• Steam 3"

You can press and hold the auxiliary function key 2 for 3 seconds to select this function. Use this programme to reduce the wrinkles and shorten the ironing times for a small amount of cotton, synthetic or mixed clothes that are not stained.

• Child Lock 3"

You can use the Child Lock to prevent children from tampering with the machine. Thus you can avoid any changes in a running programme.



INFORMATION

- When the Child Lock is enabled, you can press the On/Off key to switch the machine on or off. Programme resumes when you start the machine again.
- You will hear a warning if the buttons are pressed while Child Lock is enabled. This audible warning will be cancelled if the buttons are pressed five times consecutively.

To enable Child Lock:

Press and hold the Drying Level

Adjustment button for 3 seconds. When the countdown "3-2-1" on the display ends, child lock icon will be displayed. Once you see this warning, you can release the **Drying Level**

Adjustment button.

To disable Child Lock:

Press and hold the Drying Level

Adjustment button for 3 seconds. When the countdown "3-2-1" on the display ends, child lock icon will disappear.

• Bluetooth 3"

You can use the Bluetooth connection function to pair your machine with your smart device. This way, you can use your smart device to get information about your machine and control it.

To enable Bluetooth:

Press and hold the Remote Control function button for 3 seconds. You will see the countdown “3-2-1”, and bluetooth symbol will be displayed. Release the **Remote Control function button**. The Bluetooth icon will flash while the product is being paired with the smart device. If the connection is successful, the light of the icon will remain on.

To disable Bluetooth:

Press and hold the Remote Control function button for 3 seconds. You will see the countdown “3-2-1”, and bluetooth symbol will be disappear.



INFORMATION

- You must complete the first setup of the HomeWhiz app for Bluetooth to be enabled. After the setup, if you press the Remote Control function button while the button is in the Programme Download/Remote Control position, the Bluetooth connection will be enabled automatically.

5.12 Drying steps

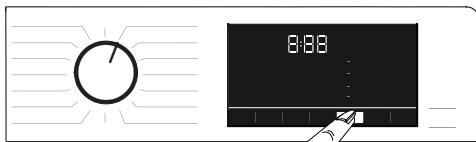

5.12.1 Iron Dry

Drying continues until the drying level reaches the Iron Dry step.

5.12.2 Cupboard Dry

Drying continues until the drying level reaches the Cupboard Dry step.

5.12.3 Extra Dry

Drying continues until the drying level reaches the Cupboard Extra Dry step.



INFORMATION

- The dryness level might change depending on the mix of laundry, type of material, amount and wetness level of the laundry.
- Do not use the machine to dry laundry that contains lace, tulle, bling, beads, paillette, wire etc. or laundry with high silk content.

5.12.4 Time based drying - minutes

You can select 30, 90 or 150 minutes drying to reach the desired dryness level at a low temperature.



INFORMATION

- When drying small amount of laundry (2 pieces maximum), select the timed drying steps in the Cottons or Synthetics drying programmes.
- If the laundry has not reached the desired dryness level at the end of the drying programme, you can select timed drying to end the process.
- When this function is selected, the machine performs drying for the adjusted time irrespective of the drying level.

5.13 Time display

While the programme is running, the time remaining to the end of the programme will be displayed in hours and minutes, e.g. “01:30”.



INFORMATION

- Programme time may differ from the values in section "Programme and consumption table" depending on the water pressure, water hardness and temperature, ambient temperature, amount and the type of laundry, auxiliary functions selected and the changes in the mains voltage.

5.14 End Time

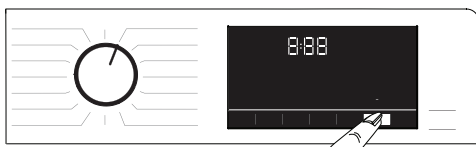

With the **End Time** function, start of the programme can be delayed up to 24 hours. After pressing the **End Time** button, the programme's estimated end time will be displayed. If an **End Time** is set, the **End Time** light will turn on.

To ensure that the End Time function is enabled and the programme ends at the end of the defined duration, you should press **Start / Pause** after setting the duration. The **Start / Pause** button will stop flashing and remain on. If you want to cancel End Time function, press the **End Time** button until the End Time light turns off or press the **On/Off** button to turn off and on the machine.

1. Open the loading door, place the laundry and add detergent, etc.
2. Select the washing programme, temperature, spin speed and, if required, the auxiliary functions.
3. Press the **End Time** button to set the desired end time. The **End Time** light will turn on.
4. Press the **Start / Pause** button. Countdown will start.



INFORMATION

- Do not use liquid detergents when you enable the End Time function! Stains might remain on the clothes.
- The door will remain locked during the End Time countdown. If you want to unlock the door, press the programme start/pause button to switch the machine to pause mode. At the end of the countdown, End Time indicator turns off, washing cycle starts and the time of the selected programme appears on the display.

5.15 Starting the programme

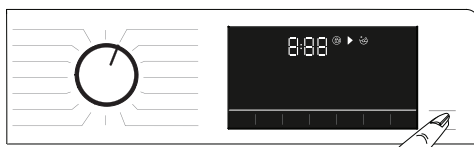

1. Press the **Start/Pause** button to start the programme.
2. The flashing light of the **Start/Pause** button will remain on, indicating that the programme has started.
3. Loading door will be locked. When the door is being locked, "Locking Door" warning will be displayed.

5.16 Loading door lock



There is a locking system on the loading door of the machine that prevents opening of the loading door when the water level is unsuitable to open the door.

"Loading door locked" light on the panel turns on when the loading door is locked.



INFORMATION

- The door will be locked if the Remote Control function is selected. To open the door, you need to press the Remote Control key or change the programme position to deactivate the Remote Control function.

Opening the loading door in case of power failure:



INFORMATION

- In case of a power failure, you can use the loading door emergency handle under the pump filter lid to manually open the loading door.



WARNING!

- Before opening the loading door, make sure that there is no water in the machine to avoid flooding. Water may be hot and could cause scalding.

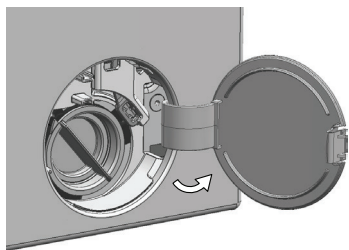

- Turn off and unplug the appliance.
- Open the pump filter lid.

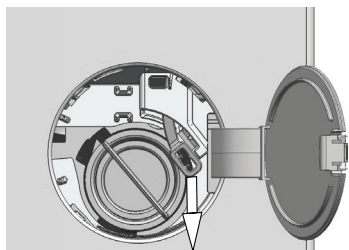

- Remove the loading door emergency handle behind the filter cover with a tool.
- Open the loading door by pulling the loading door emergency handle downwards.
- Try to pull the handle downwards again if the loading door is not opened.
- Bring the loading door emergency handle to its original position after opening the loading door.

5.17 Changing the selections after programme has started

5.17.1 Adding laundry after the programme has started

When you press the **Start/Pause** button, the "Loading door locked" light on the panel will go off if the water level in the machine is suitable.

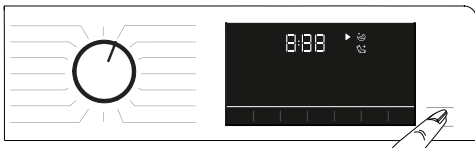

If the water level in the machine is not suitable when you press the **Start/Pause** button, the panel will warn you that the door is closed.

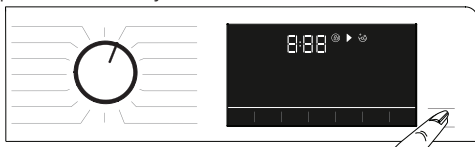

5.17.2 Switching the machine to pause mode

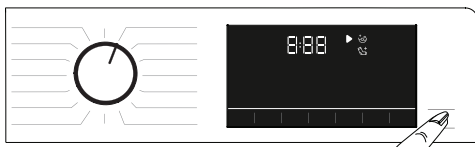

Press the **Start/Pause** button to switch the machine to pause mode.

5.17.3 Changing the programme selection after the programme has started:

If Child Lock is not enabled, you can change programme while the current one is running. This will cancel the current programme.



INFORMATION

- The newly selected programme will start anew.

5.17.4 Changing the auxiliary function, spin speed and temperature settings

Depending on the step the programme has reached, you can cancel or select auxiliary functions. See "Auxiliary function selection". Also, you can change the spin speed, temperature and drying settings. See "Spin speed selection" and "Temperature selection".



INFORMATION

- If the temperature of the water inside the machine is high or if the water level is above the door line, the loading door will not open.

5.18 Cancelling the programme

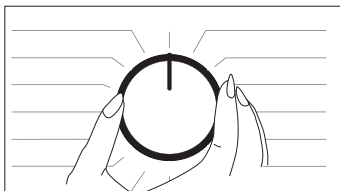

The programme will be cancelled if the programme selection knob is switched to another programme or if the machine is switched off and on with this button.



INFORMATION

- The programme will not be cancelled if you turn the programme selection knob while child lock is enabled. You should cancel the Child Lock first.
- If you want to open the loading door after you have cancelled the programme but you cannot do it since the water level in the machine is above the loading door baseline, turn the Programme Selection knob to Pump+Spin programme and discharge the water in the machine.

5.19 End of programme

Once the programme is completed, the End symbol will be displayed.

If you do not press any button for 10 minutes, the machine will switch to OFF mode. Display and all indicators are turned off.

If you press any button, the completed programme steps will be displayed.

5.20 Your machine has the "Pause Mode" function.

After using the On/Off button to switch on the machine, if you do not start any programme in the selection step or do not perform anything else, or if you do not do anything in 2 minutes after the selected programme has ended, the programme will automatically switch to energy saving mode. Also, if your product has a display that shows programme time, this display will be completely turned off. If you turn the programme knob or touch any button, the lights will switch back to previous position. The selections you make when exiting the energy efficiency mode may change. Check if your selections are correct before starting the programme. If necessary, make adjustments again. This is not an error.

5.21 HomeWhiz and the Remote Control Function

HomeWhiz allows you to use your smart device to control your washing machine and get information about it. Thanks to the HomeWhiz application, you can use your smart device to carry out some procedures you can also do on the machine. Plus, you can use some features only with the HomeWhiz function.

To use the Bluetooth function of your machine, you should download the HomeWhiz app from the application store of your device.

Make sure that your smart device is connected to internet to download the app.

If you are using the app for the first time, please follow the on-screen instructions to complete the user registration process. Once the registration is complete, you can use all products with the HomeWhiz feature in your house on this account. On the HomeWhiz app, you can tap "Add/Remove Appliance" to see the products paired with your account. You can pair these products on this page.



INFORMATION

- To be able to use the HomeWhiz function, make sure that the app is installed on your smart device and that your washing machine is paired with your smart device via Bluetooth. If the washing machine is not paired with your smart device, it will function as an appliance without the HomeWhiz feature.
- Your product will run once it is paired with your smart device via Bluetooth. Controls made from the app will be enabled through this pairing. For this reason, the Bluetooth signal between the product and the smart device must be strong enough.
- Please visit www.homewhiz.com to see the Android and iOS versions supported by the HomeWhiz application.



WARNING!

- All the safety measures described in "**GENERAL SAFETY INSTRUCTIONS**" section of your user manual apply to remote control through the HomeWhiz function as well.

5.21.1 HomeWhiz Setup

Your product and the HomeWhiz app must be connected for the app to run. To establish this connection, please follow the steps below for setup both on your product and on the HomeWhiz App.

- If you are adding an appliance for the first time, tap “Add/Remove Appliance” on the HomeWhiz App. Then tap “Tap here to setup new appliance”. Follow the steps below as well as the instructions on the HomeWhiz App to complete the setup.
- To start the setup process, make sure that your machine is switched off. Press and hold the Temperature button and the Remote Control Function button simultaneously for 3 seconds to switch your machine to HomeWhiz setup mode.

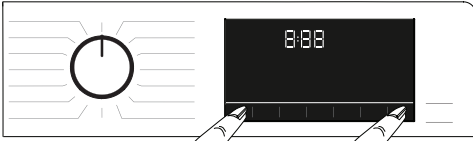

- While the device is in HomeWhiz setup mode, you will see an animation on the display, and the Bluetooth icon will flash until the machine is paired with your smart device. In this mode, only the programme button is enabled. Other buttons are disabled.

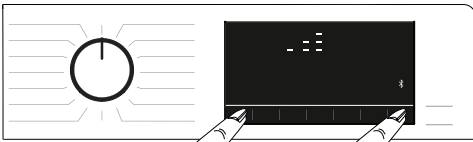

- On the screen of the app, select the desired washing machine and tap Next.
- Follow on-screen instructions until the HomeWhiz app asks you about the product you wish to connect to your smart device.
- Return to the HomeWhiz app and wait until the setup is complete. Once the setup is complete, give your washing machine a name. You can now tap the screen to see the product you have added to the HomeWhiz App.



INFORMATION

- If you cannot complete the setup successfully in 5 minutes, the washing machine will switch off automatically. In this case, you will have to start over the setup procedure. If the problem persists, please contact the Authorised Service Agent.
- You can use your washing machine with more than one smart device. To do this, download the HomeWhiz app on the other smart device as well. After launching the app, you will need to sign in to your account you have previously created and paired with your washing machine. Otherwise, please read “Setting up a washing machine that is connected to someone else’s account”.



WARNING!

- For HomeWhiz setup, your smart device must be connected to internet. Otherwise, the HomeWhiz App will not let you complete the setup process successfully. If you are having problems with your internet connection, please contact your internet service provider.



INFORMATION

- The HomeWhiz application may ask you to enter the product number stated on the label of the product. Product label is found on the inner side of the product door. Product number is written on this label.



5.21.2 Setting up a washing machine that is connected to someone else’s account

If the washing machine you want to use has previously been registered in the system with someone else’s account, you need to establish a new connection between the HomeWhiz App and the product.

- Download the HomeWhiz App on the new smart device you want to use.
- Create a new account and log in to this account on the HomeWhiz app.

- Follow the steps in the HomeWhiz Setup (5.21.1 HomeWhiz Setup) to complete the setup.



WARNING!

- Since the HomeWhiz and Remote Control functions of your product work through pairing via Bluetooth, the product can be run by only one HomeWhiz app at a time.

When Remote Control is enabled, you can only manage and switch off the machine and follow status on the washing machine. All functions except child lock can be managed through the application.

You can check the function indicator on the key to follow whether the Remote Control function is On or Off.

If the Remote Control function is Off, all the operations are handled on the washing machine and only status follow-up is allowed on the application.

If the Remote Control function cannot be enabled, you will hear a warning after pressing the button. This might occur if the product is switched on or if there is no product paired through Bluetooth. Bluetooth setting being Off or the washing machine's door being open are examples for such cases.

When you enable this function on the washing machine, said function will remain on except for certain cases, allowing you to control your washing machine remotely via Bluetooth.

In certain cases, it deactivates itself for safety reasons:

- When your washing machine undergoes a power interruption.
- When the programme knob is turned to select a different programme or when the product is switched off.

5.21.4 Troubleshooting

Follow the steps below if you are having problem with controlling or connection. Observe whether the problem persists or not after the action you have performed. Do the following if the problem is not resolved.

- Check whether your smart device is connected to the relevant home network.
 - Restart the product application.
 - Turn Bluetooth off and on through the user control panel.
 - If the connection cannot be established with the above processes, repeat the initial set-up settings on the washing machine.
- If the problem persists, consult an Authorised Service Agent.

After HomeWhiz setup, Bluetooth will turn on automatically. To enable or disable the Bluetooth connection, please see 5.11.2 Bluetooth 3".

If you switch your machine off and on while Bluetooth is enabled, it will reconnect automatically. If the paired device goes out of the range, the Bluetooth connection will turn off automatically. For this reason, you will need to turn on Bluetooth again if you want to use the Remote Control function.

You can check the Bluetooth symbol on the display to follow the connection status. If the symbol is on, this means that the Bluetooth connection is established. If the symbol is established, the product is trying to connect. If the symbol is off, this means that you have no connection.



WARNING!

- If the Bluetooth connection is enabled on your product, you can select the Remote Control function. If the Remote Control function cannot be selected, check the connection status. If the connection fails, repeat the initial set-up settings on the appliance.
- For safety reasons, the product's door will remain locked while the Remote Control function is enabled, independently of the operating mode. If you want to open the door of the product, you will need to turn the programme selection knob or press the Remote Control key to disable the Remote Control function.

If you want to control your washing machine remotely, enable the Remote Control function by pressing the Remote Control button while the programme knob is in the Programme Download/Remote Control position on the control panel. Once the product is accessed, you will see a screen similar to the one below.

6 Maintenance and cleaning

Service life of product extends and frequently experienced problems will be reduced if it is cleaned at regular intervals.

6.1 Cleaning the detergent drawer

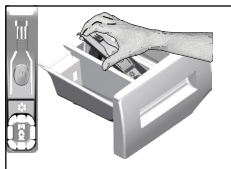

Clean the detergent drawer at regular intervals (every 4-5 washing cycles) as shown below in order to prevent accumulation of powder detergent in time.

- 1 Remove the siphon by lifting it from behind as shown in the picture. After performing the below mentioned cleaning procedures, replace the siphon back to its seating and push its front section downwards to make sure that the locking tab engages.



INFORMATION

- If more than normal amount of water and softener mixture remains in the softener compartment, the siphon must be cleaned.

2. Wash the detergent drawer and the siphon with plenty of lukewarm water in a washbasin. In order to prevent the residues to contact your skin, clean it with an appropriate brush by wearing a pair of gloves.
- 3 Insert the drawer back into its place after cleaning and make sure that it is seated well.

6.2 Cleaning the loading door and the drum

For products with drum cleaning programme, please see Operating the product - Programmes.



INFORMATION

- Repeat Drum Cleaning process in every 2 months.
- Use an detergent /anti-limescale suitable for the washing machines.



After every washing and drying make sure that no foreign substance is left in the drum. If the holes on the bellow shown in the figure are blocked, open the holes using a toothpick.



INFORMATION

- Foreign metal substances will cause rust stains in the drum. Clean the stains on the drum surface by using cleaning agents for stainless steel. Never use steel wool or wire wool.



CAUTION!

- Never use sponge or scrub materials. These will damage the painted, chrome and plastic surfaces.

6.3 Cleaning the body and control panel

Wipe the body of the machine with soapy water or non-corrosive mild gel detergents as necessary, and dry with a soft cloth.

Use only a soft and damp cloth to clean the control panel.

6.4 Cleaning the water intake filters

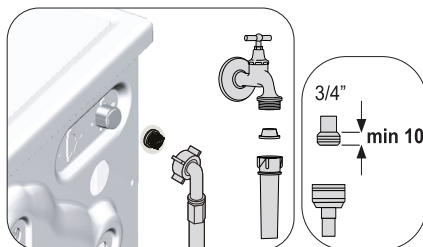

There is a filter at the end of each water intake valve at the rear of the machine and also at the end of each water intake hose where they are connected to the tap. These filters prevent foreign substances and dirt in the water to enter the washing machine. Filters should be cleaned if they are dirty.

1. Close the taps.
2. Remove the nuts of the water intake hoses to access the filters on the water intake valves. Clean residues on them with an appropriate brush. If the filters are too dirty, remove them from their places with a pliers and clean in this way.
3. Take out the filters on the flat ends of the water intake hoses together with the gaskets and clean thoroughly under running water.
4. Replace the gaskets and filters carefully in their places and tighten the hose nuts by hand ensuring there are no leaks.

2. Open the filter cover. Press the tab in the direction of the arrow and pull the cover out towards yourself.

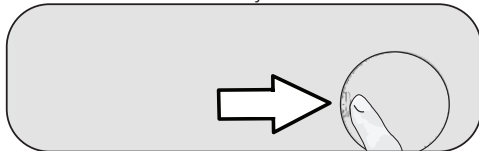

3. To drain the water in the machine.

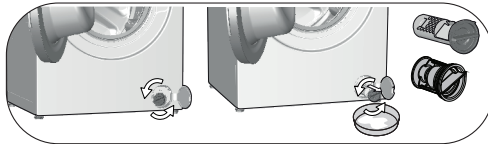

- a. In order to collect the water to flow out of the filter, place a large shallow vessel in front of the filter.
 - b. Turn and loosen the pump filter until water starts to flow (counterclockwise). Fill the flowing water into the container you have placed in front of the filter. Always keep a piece of cloth handy to absorb any spilled water.
 - c. When the water inside the machine is finished, take out the filter completely by turning it.
4. Clean any residues inside the filter as well as fibres, if any, around the pump impeller region.
 5. Replace the filter.
 6. Close the filter cover.

6.5 Draining remaining water and cleaning the pump filter

The filter system in your machine prevents solid items such as buttons, coins and fabric fibres clogging the pump impeller during discharge of washing water. Thus, the water will be drained without any problem and the service life of the pump will extend.

If the machine fails to drain water, the pump filter is clogged. Filter must be cleaned whenever it is clogged or in every 3 months. Water must be drained off first to clean the pump filter.

In addition, prior to transporting the machine (e.g., when moving to another house) and in case of freezing of the water, water may have to be drained completely.



CAUTION!

- Foreign substances left in the pump filter may damage your product or may cause noise problem.
- If the product is not being used, shut the tap, remove mains hose and drain the water inside the machine in places where there is the risk of the product freezing .
- After each use, turn off the water tap to which the mains hose is connected.

1. In order to clean the dirty filter and discharge the water, unplug the machine to cut off the supply power.



CAUTION!

- Temperature of the water inside the machine may rise up to 90 °C. To avoid the risk of burning, clean the filter after the water inside the machine is cooled down.

7 Troubleshooting

Programmes won't start after the loading door has been closed.

- You did not press the Start/Pause/Cancel button.>>> *Press the Start/Pause/Cancel button.
- If the load is too much, it might be hard for the loading door to be closed.>>> *Load less laundry and make sure that the loading door is closed properly.

Programme cannot be started or selected.

- The machine may have switched itself to self-protection mode due to a supply problem (mains voltage, water pressure etc.).>>> To cancel the programme, turn the Programme Selection knob to select another programme. Previous programme will be cancelled. (see. "Cancellation of programme")

Water inside the machine.

- There might be some water remaining in the product due to the quality control processes carried out during production. >>> This is not a failure, water does not harm the machine.

Water is leaking from the bottom of the machine.

- There might be a problem with the hoses or the pump filter.>>> Make sure that the seals of the water inlet hoses are securely fitted. Attach the hose to the tap tightly.
- Pump filter might not be closed securely. >>> Make sure that the pump filter is closed securely.

Machine does not take in water.

- Tap might be turned off. >>> Turn on the taps.
- Water inlet hose might be bent. >>> Flatten the hose.
- Water inlet filter might be clogged. >>> Clean the filter.
- Loading door might not be closed. >>> Close the loading door.

Machine does not drain water.

- Water drain hose might be clogged or twisted. >>> Clean or flatten the hose.
- Pump filter might be clogged. >>> Clean the pump filter.

Machine vibrates or makes noise.

- Machine might be unbalanced. >>> Adjust the feet to level the machine.
- A hard substance might have entered the pump filter. >>> Clean the pump filter.
- Transportation safety bolts might not be removed. >>> Remove the transportation safety bolts.
- The amount of laundry might be too little. >>> Add more laundry to the machine.
- The machine might be overloaded with laundry. >>> Take out some of the laundry from the machine or distribute the load by hand to balance it evenly in the machine.
- The machine might be in contact with a hard surface. >>> Make sure that the machine is not in contact with anything.

Machine stopped shortly after the programme started.

- The machine might have stopped temporarily due to low voltage. >>> It will resume running once the voltage returns to a normal level.

Machine directly discharges the water it takes in.

- The drain hose might be at an inappropriate height. >>> Connect the water drain hose as described in the user manual.

No water can be seen in the machine during washing.

- Water level cannot be seen outside the machine. This is not a failure.

Loading door cannot be opened.

- Door lock might be enabled because of the water level in the machine. >>> Drain the water by running the Pump or Spin programme.
- Machine might be heating the water or at the spinning step.>>> Wait until the programme is complete.
- The loading door might be jammed due to the pressure it is exposed to. >>> Hold the grip, push and pull the loading door to free it from the pressure and open it.
- The loading door will not open if there is no power. >>> To open the loading door, open the pump filter cap and pull down the emergency handle positioned at the rear side of the said cap. See "Loading door lock"

Washing takes longer than specified in the user manual.(*)

- Water pressure might be low. >>> Since the amount of the water has decreased, the machine will wait until it takes adequate water to avoid poor washing quality. Therefore, the washing time extends.
- Voltage might be low. >>> If the supply voltage is low, the washing time is extended to prevent poor washing quality.
- Inlet temperature of water might be too low. >>> The time required to heat up the water extends in cold seasons. Also, washing time can be extended to avoid poor washing results.
- The number of rinsing cycles and/or the amount of rinsing water might have increased. >>> When a better rinsing performance is needed, the machine increases the amount of rinsing water, and adds another rinsing cycle, if necessary.
- Excessive foam might have formed due to use of too much detergent, and the automatic foam absorption system might have been activated. >>> Use the recommended amount of detergent.

Programme time does not countdown. (On models with display) (*)

- The timer may stop during water intake. >>> The timer indicator will not count down until the machine takes in an adequate amount of water. When the amount of the water taken in decreases, the machine will wait until it takes in enough water to avoid poor washing results. Timer indicator will resume countdown after this.
- The timer indicator might stop during heating. >>> The timer indicator will not count down until the machine reaches the selected temperature.
- The timer indicator might stop during spinning. >>> The automatic unbalanced load detection system might have been activated due to uneven distribution of the laundry in the drum.

Programme time does not countdown. (*)

- The laundry in the machine might be unbalanced. >>> The automatic unbalanced load detection system might have been activated due to uneven distribution of the laundry in the drum.

Machine does not switch to spinning step. (*)

- The laundry in the machine might be unbalanced. >>> The automatic unbalanced load detection system might have been activated due to uneven distribution of the laundry in the drum.
- The machine cannot spin if the water in it is not drained completely. >>> Check the filter and the drain hose.
- Excessive foam might have formed due to use of too much detergent, and the automatic foam absorption system might have been activated. >>> Use the recommended amount of detergent.

Washing performance is poor: Clothes are going grey. ()**

- Insufficient amount of detergent might have been used over a long period of time. >>> Use the recommended amount of detergent according to water hardness and the laundry.
- Washing might have been performed at low temperatures for a long time. >>> Select the proper temperature for the laundry to be washed.
- Hard water and insufficient amount of detergent. >>> Using hard water together with insufficient amount of detergent might cause dirt accumulation and greying on laundry in time. It is difficult to eliminate greying once it happens. Use the recommended amount of detergent appropriate for water hardness and the laundry.
- Excessive amount of detergent might have been used. >>> Use the recommended amount of detergent appropriate for water hardness and the laundry.

Washing performance is poor: Stains persist or the laundry is not whitened. ()**

- Insufficient amount of detergent might have been used. >>> Use recommended amount of detergent appropriate for the laundry.
- Machine might have been overloaded. >>> Do not overload the machine. Load the machine with the amounts recommended in the "Programme and consumption table".
- Wrong programme and temperature might have been selected. >>> Select the right programme and temperature for the laundry to be washed.
- Wrong type of detergent might have been used. >>> Use original detergent appropriate for the machine.
- Detergent might have been put in the wrong compartment. >>> Put the detergent in the correct compartment. Do not mix the bleaching agent and the detergent with each other.

Washing performance is poor: Oily stains appeared on the laundry. ()**

- The drum might not have been cleaned regularly. >>> Clean the drum regularly. To do this, please see. 6.2.

Washing performance is poor: Clothes smell bad. ()**

- Washing at low temperatures and/or with short programmes for a long time will cause smell and bacteria in the drum. >>> Leave the detergent drawer and loading door of the machine ajar after every washing cycle. Thus, a humid environment favorable for bacteria cannot occur in the machine.

Colour of the clothes faded. ()**

- Machine might have been overloaded. >>> Do not overload the machine.
- Detergent used might be damp. >>> Keep detergents closed in an environment free of humidity and do not expose them to excessive temperatures.
- A high temperature might have been selected. >>> Select a programme and temperature suitable for the type and soiling degree of the laundry.

Rinsing performance is poor

- The amount, brand or storage conditions of the detergent might not be suitable. >>> Use a detergent appropriate for the washing machine and your laundry. Keep detergents closed in an environment free of humidity and do not expose them to excessive temperatures.
- The detergent might have been added to the wrong compartment. >>> If you add detergent to the prewash compartment even if you have not selected a prewash programme, the machine might take this detergent during the rinsing or softener step. Put the detergent in the correct compartment.
- Pump filter might have been clogged. >>> Check the filter.
- Drain hose might be folded. >>> Check the drain hose.

Laundry became stiff after washing. ()**

- Insufficient amount of detergent might have been used. >>> Using insufficient amount of detergent for the water hardness can cause the laundry to become stiff in time. Use appropriate amount of detergent according to the water hardness.
- The detergent might have been added to the wrong compartment. >>> If you add detergent to the prewash compartment even if you have not selected a prewash programme, the machine might take this detergent during the rinsing or softener step. Put the detergent in the correct compartment.
- Detergent might have been mixed with softener. >>> Do not mix the detergent with softener. Wash and clean the drawer with hot water.

Laundry does not smell like softener. ()**

- The detergent might have been added to the wrong compartment. >>> If you add detergent to the prewash compartment even if you have not selected a prewash programme, the machine might take this detergent during the rinsing or softener step. Wash and clean the drawer with hot water. Put the detergent in the correct compartment.
- Detergent might have been mixed with softener. >>> Do not mix the detergent with softener. Wash and clean the drawer with hot water.

Detergent residue in the detergent drawer. ()**

- Detergent might have been added to wet drawer. >>> Dry the detergent drawer before adding detergent.
- The detergent might have gotten damp. >>> Keep detergents closed in an environment free of humidity and do not expose them to excessive temperatures.
- Water pressure might be low. >>> Check the water pressure.
- The detergent in the main wash compartment got wet while the machine was taking in the prewash water. Holes of the detergent compartment might have been blocked. >>> Check the holes and clean if they are clogged.
- There might be a problem with the detergent drawer valves. >>> Call the Authorised Service Agent.
- Detergent might have been mixed with softener. >>> Do not mix the detergent with softener. Wash and clean the drawer with hot water.

There is detergent left on the laundry.

- Machine might have been overloaded. >>> Do not overload the machine.
- Wrong programme and temperature might have been selected. >>> Select the right programme and temperature for the laundry to be washed.
- Wrong detergent might have been used. >>> Select a proper detergent for the laundry to be washed.

Too much foam forms in the machine. (**)

- Improper detergents for the washing machine might have been used. >>> Use detergents suitable for washing machine.
- Excessive amount of detergent might have been used. >>> Use only sufficient amount of detergent.
- Detergent might have been stored under inappropriate conditions. >>> Keep the detergent in a closed and dry area. Do not store it in excessively hot places.
- Meshed laundry such as tulle might foam too much due to their texture. >>> Use less detergent for these types of fabrics.
- Detergent might have been put in the wrong compartment. >>> Put the detergent in the correct compartment.
- Softener is taken early. >>> There might be a problem with the valves or the detergent drawer. Call the Authorised Service Agent.

Foam is overflowing from the detergent drawer.

- Excessive amount of detergent might have been used. >>>> Mix 1 tablespoonful softener and ½ l water and pour into the main wash compartment of the detergent drawer.
- Put detergent into the machine suitable for the programmes and maximum loads indicated in the "Programme and consumption table". If you use additional chemicals (stain removers, bleaches and etc), reduce the amount of detergent.

Laundry remains wet at the end of the programme. (*)

- Excessive foam might have formed due to use of too much detergent, and the automatic foam absorption system might have been activated. >>> Use the recommended amount of detergent.

Drying lasts too long.

- Machine might have been overloaded. >>> Do not overload the machine.
- Spinning might not be sufficient for laundry. >>> Select a higher spin speed in the washing step of the Washer-Dryer.
- Tap might be turned off. >>> Turn on the taps.

Laundry comes off wet after the drying step.

- The programme selected might not be suitable for the type of laundry. >>>> Check the care labels on garments and select a programme accordingly, or select timed programmes additionally.
- Machine might have been overloaded. >>> Do not overload the machine.
- Spinning might not be sufficient for laundry. >>> Select a higher spin speed in the washing step of the Washer-Dryer.

Machine does not start or programme cannot be started.

- Power cable might be unplugged. >>> Make sure that the power cable is plugged in.
- Programme might not be set, or the Start/Pause/Cancel button might not be pressed. >>> Make sure the programme is set and the machine is not in Stand-by mode.
- Child lock might be enabled. >>> Disable Child Lock.

Laundry shrinks, fades, tarnishes or gets damaged.

- The programme selected might not be suitable for the type of laundry. >>>> Check the care labels on garments and select a programme accordingly, or select timed programmes additionally. You should not dry laundry that is not suitable for drying.

Machine does not dry.

- Laundry might not be dried or the drying step might not be enabled. >>> Check if the drying function is selected after the selected washing programme.

Loading door cannot be opened.

- The door of your machine might not be opening due to safety reasons. >>> If the door locked indicator is active on the display after the drying step, the machine will keep the door locked for your safety until it cools down.
- The loading door will not open if there is no power. >>>> To open the loading door, open the pump filter cap and pull down the emergency handle positioned at the rear side of the said cap. See "Loading door lock"

(*) Machine does not switch to spinning step when the laundry is not evenly distributed in the drum to prevent any damage to the machine and to its surrounding environment. Readjust the laundry and perform spinning again.

(**) The drum might not have been cleaned regularly. >>> Clean the drum regularly. See 6.2



CAUTION!

- If you cannot eliminate the problem although you follow the instructions in this section, consult your dealer or the Authorised Service Agent. Never try to repair a nonfunctional product yourself.



WARNING!

- Check the HomeWhiz section for the relevant troubleshooting information.

DISCLAIMER / WARNING (EN)

Some (simple) failures can be adequately handled by the end-user without any safety issue or unsafe use arising, provided that they are carried out within the limits and in accordance with the following instructions (see the “Self-Repair” section).

Therefore, unless otherwise authorized in the “Self-Repair” section below, repairs shall be addressed to registered professional repairers in order to avoid safety issues. A registered professional repairer is a professional repairer that has been granted access to the instructions and spare parts list of this product by the manufacturer according to the methods described in legislative acts pursuant to Directive 2009/125/EC.

However, only the service agent (i.e. authorized professional repairers) that you can reach through the phone number given in the user manual/warranty card or through your authorized dealer may provide service under the guarantee terms. Therefore, please be advised that repairs by professional repairers (who are not authorized by Beko) shall void the guarantee.

Self-Repair

Self-repair can be done by the end-user with regard to the following spare parts: door, door hinge and seals, other seals, door locking assembly and plastic peripherals such as detergent dispensers (an updated list is also available in support.beko.com as of 1st of March 2021).

Moreover, to ensure product safety and to prevent risk of serious injury, the mentioned self-repair shall be done following the instructions in the user manual for self-repair or which are available in support.beko.com. For your safety, unplug the product before attempting any self-repair.

Repair and repair attempts by end-users for parts not included in such list and/or not following the instructions in the user manuals for self-repair or which are available in support.beko.com, might give raise to safety issues not attributable to Beko, and will void the warranty of the product.

Therefore, it is highly recommended that end-users refrain from the attempt to carry out repairs falling outside the mentioned list of spare parts, contacting in such cases authorized professional repairers or registered professional repairers. On the contrary, such attempts by end-users may cause safety issues and damage the product and subsequently cause fire, flood, electrocution and serious personal injury to occur.

By way of example, but not limited to, the following repairs must be addressed to authorized professional repairers or registered professional repairers: motor, pump assembly, main board, motor board, display board, heaters etc.

The manufacturer/seller cannot be held liable in any case where end-users do not comply with the above.

The spare part availability of the washing machine or washer-dryer that you purchased is 10 years. During this period, original spare parts will be available to operate the washing machine or washer-dryer properly.

