



## Built-in Gas Cooktop

User Manual

### **IMPORTANT**

**Installer** should leave these instructions with appliance.

**Consumer** should read these instructions before using the appliance and should retain them for future reference.

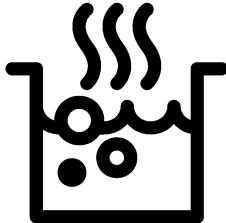

BCTG24400SS

**EN**

185.9278.47/R.AC/20.08.2020/3-1

7750188336

# **IMPORTANT SAFETY INSTRUCTIONS**

## **READ AND SAVE THESE INSTRUCTIONS**



**WARNING:** Read all safety instructions before using the product. If the information in this manual is not followed exactly, a fire or explosion may result causing property damage, personal injury or death.

- Do not store or use gasoline or other flammable vapors and liquids in the vicinity of this or any other appliance.
- **WHAT TO DO IF YOU SMELL GAS**
  - Do not try to light any appliance.
  - Do not touch any electrical switch.
  - Do not use any phone in your building.
  - Immediately call your gas supplier from a neighbor's phone. Follow the gas supplier's instructions.
  - If you cannot reach your gas supplier, call the fire department.
- Installation and service must be performed by a qualified installer, service agency or the gas supplier.

---

This product was manufactured using the latest technology in environmentally friendly conditions.



## IMPORTANT:

This appliance is intended for normal household use only. It is not approved for outdoor or other non-household uses (including sea or air-going vessels). See the Statement of Limited Warranty. If you have any questions, contact the manufacturer.

Do not repair or replace any part of the appliance unless specifically recommended in this manual. Refer all servicing to a factory authorized service center.

## Explanation of symbols

Throughout this User Manual the following symbols are used:



Important information or useful hints about usage.



Warning for hazardous situations with regard to life and property.



Warning for electric shock.



Warning for risk of fire.



Warning for hot surfaces.

**DANGER** indicates a hazardous situation which, if not avoided, will result in death or serious injury.

**WARNING** indicates a hazardous situation which, if not avoided, could result in death or serious injury.

**CAUTION** indicates a hazardous situation which, if not avoided, could result in minor or moderate injury.

**NOTICE** is used to address practices not related to physical injury.

Dear Customer,

Your product has been manufactured in modern facilities and has passed strict quality control procedures.

To obtain the best performance, we request that you read through this user manual carefully, especially the safety instructions, before using your product and that you keep it for future reference. If this product is given to another consumer, please give them this manual for their reference.



**IMPORTANT:**

**Save these instructions for the local electrical inspectors use.**



**IMPORTANT:**

**This product can only be used in a room which incorporates a properly adjusted and functioning Carbon Monoxide and smoke sensors. Make sure the Carbon Monoxide and smoke sensors work properly and are maintained done frequently. Carbon Monoxide and smoke sensor should be installed maximum 6.5 feet away from the product.**

**The instructions will help you to operate the appliance properly and safely.**

- Upon delivery, please check that the appliance is not damaged. If you note any transport damage, please contact the shipping company or company where you purchased the appliance immediately and do not connect and operate the appliance!
- When you pass on the appliance to another person, please provide all documents including original sales receipt which should show the date of purchasing. Warranty is not valid if the product is sold second hand.
- If you should decide not to use this appliance any longer (or decide to substitute an older model), before disposing of it, it is recommended that it be made inoperative in an appropriate manner in accordance with health and environmental protection regulations, ensuring in particular that all potentially hazardous parts be made harmless, especially in relation to children who could play with old appliances.

## TABLE OF CONTENTS

### **1 Safety Instructions - Read before use**

**6**

Basic safety instructions .....	6
Safety for children .....	8
Safety when working with electricity .....	9
Safety when working with gas .....	9
Intended use .....	11
Disposal .....	11
Packaging material .....	11
Future transportation .....	12

### **2 Preparation**

**13**

Tips for saving energy .....	13
Initial use .....	13
First cleaning of the appliance .....	13
Initial heating .....	13

### **3 How to use the cooktop**

**14**

General information about cooking .....	14
Using the cooktop .....	15

### **4 Maintenance and care**

**17**

General information .....	17
Cleaning the burner/plate .....	17
Cleaning the control panel .....	18

### **5 General information**

**19**

Overview .....	19
Technical specifications .....	20
Injector table .....	21

### **6 Troubleshooting**

**22**

### **7 BEKO US RESIDENTIAL PRODUCT WARRANTY**

**23**

## **1 Safety Instructions - Read before use**



### **Basic safety instructions**

- This appliance is not intended for use by persons (including children) with reduced physical, sensory or mental capabilities, or lack of experience and knowledge, unless they have been given supervision or instruction concerning use of appliance by a person responsible for their safety.
- Children should be supervised to ensure that they do not play with the appliance.
- Never use when judgment or coordination is impaired by the use of alcohol and/or drugs
- If the supply cord damaged, it must be replaced by a special cord or assembly available from the manufacturer or its service agent or similarly qualified persons.
- Do not operate the appliance if it is defective or shows any visible damage.
- Do not carry out any repairs or modifications on the appliance. However, you may remedy some malfunctions; see Troubleshooting.
- Only authorized replacement parts may be used in performing service on the cooktop. Replacement parts are available from factory authorized parts distributors. Contact the nearest parts distributor in your area.
- Never modify or alter the construction of the cooktop including by removing screws or any other part of the appliance.
- Be careful when using alcoholic drinks in your dishes. Alcohol evaporates in high temperatures and may cause fire since it will catch fire when it gets in contact with hot surfaces.
- Your body accidentally can turn the knobs, please make sure that your body do not touch to knobs not for use.
- **WARNING:** Food Poisoning Hazard: Do not let food sit on cooktop for more than 1 hour before or after cooking. Doing so can result in food poisoning or sickness.
- **WARNING:** Never cover the top of burner grates with any kind of cover. Use only cooking utensils with recommended diameters. Otherwise fire hazard and carbon monoxide poisoning can occur.
- An air curtain or other overhead cooktop hood, which operates by blowing a downward airflow onto this cooktop, shall not be used in

conjunction with this gas cooktop.

- Do not heat closed food containers and glass jars. Pressure that may build-up in the jar can cause it to burst.
- Never leave the cooktop unattended when in use. Boilovers cause smoking and greasy spillovers may ignite.
- **WARNING:** Make sure that burner grates are always centered on top of burners, as seen in the figure below. Misplacing of burner grates may cause carbon monoxide poisoning and death. Always control burner grates position before use. Do not use a grate if the rubber feet are missing or damaged.

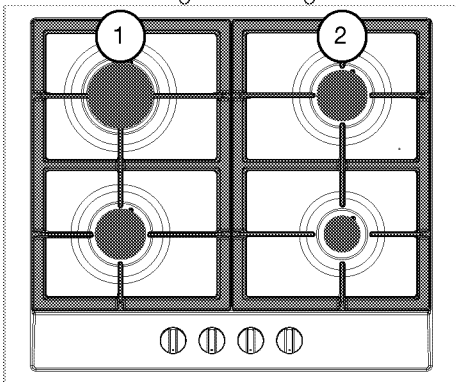

- Keep appliance area clear and free from combustible materials, gasoline, and other flammable vapors.
- Do not store or use flammable materials near the cooktop, in-

cluding paper, plastic, pot holders, linens, wall coverings, curtains, drapes and gasoline or other flammable vapors and liquids.



- Do not let cooking grase or other flammable materials accumulate in or near the cooktop. Grease on the cooktop may ignite.
- **Do not use water on grease fires.** Smother fire or flame or use dry chemical or foam type extinguisher.
- Do not allow aluminum foil, plastic, paper or cloth to come in contact with a hot surface. Do not allow pans to boil dry.
- Do not leave empty pots or pans on burners that are switched on. They might get damaged.
- Since it may be hot, do not leave plastic or aluminum dishes on the surface of appliance. These kind of dishes should not be used to keep food either.
- Use only dry pot holders-moist or damp pot holders on hot surfaces may result in burns from steam. Do not let pot holders touch surface burners or burner grate. Do not use a towel or other bulky cloth in place of pot holders.

- Bottom surface of the cooktop gets hot when it is in use. Electric connection should not touch the bottom surface, otherwise the main cable may get damaged. Do not trap the main cable between the bottom surface and kitchen furniture. Do not route the main cable over the hot cooking section. Otherwise, cable insulation may melt and cause fire as a result of short circuit.
  - If the cooktop is near a window, forced air vent or fan, be certain that flammable materials such as window coverings do not blow over or near the burners. They could catch on fire.
  - Surface units may be hot even though they are dark in color. Areas near surface units may become hot enough to cause burns. During and after use, do not touch or let clothing or other flammable materials contact surface units until they have had sufficient time to cool. Among these areas are (identification of areas) for example, the cooktop and surfaces facing the cooktop.
  - Never wear loose-fitting or hanging garments while using the appliance. Be careful when reaching for items stored in cabinets over the cooktop. Flammable material could be ignited if brought in contact with hot surfaces or burner and may cause severe burns.
  - Do not use the cooktop to dry newspapers. If overheated, they can catch on fire.
  - Check that all controls on the appliance are switched off after use.
  - The manufacturer declines all liability for injury to persons or damage to property caused by incorrect or improper use of the appliance.
  - **IMPORTANT:** Call the authorized service for installation of the appliance to be used. After this procedure, guarantee period will be started.
  - Call service for obtaining replacement parts. Contact information can be found at the last page of the user manual.
- Safety for children**
- Accessible parts may be hot when the cooktop is in use. Young children should be kept away.
  - Do not leave children alone or unattended in a area where an appliance is in use. They should never be allowed to climb, sit or stand on any part of the appliance.



- **WARNING:** Do not store items of interest to children in the cabinets above the cooktop. Children climbing on the cooktop to reach items could be seriously injured.
- The packaging materials will be dangerous for children. Keep the packaging materials away from children. Please dispose of all parts of the packaging according to environmental standards.

### **Safety when working with electricity**

-  **WARNING:** Before installing, turn power OFF at the service panel. Lock service panel to prevent power from being turned ON accidentally.
-  **WARNING:** Personal injury or death from electrical shock may occur if the cooktop is not installed by a qualified installer or electrician.
- Any additions, changes or conversions required in order for this appliance to satisfactorily meet the application needs must be made by a qualified technician.
- In case of any damage, switch off the appliance and disconnect it from the main supply by removing the fuse or switching off the circuit breaker.
- Ensure that the fuse rating is correct.

- Do not operate the appliance barefooted.
- Never touch the appliance with wet hands or feet.

### **Safety when working with gas**

- **WARNING:** To reduce the risk of personal injury in the event of a grease fire, do the following:
  1. First be sure that gas shut off valve and all burner controls are in the OFF position before beginning.
  2. Smother flames with a close-fitting lid, cookie sheet, or metal tray, then turn off the burner.
  3. If the flames do not go out immediately, evacuate and call the fire department.
  4. Never pick up a flaming pan.
  5. Do not use water, including wet rags or towels. A violent steam explosion could occur.

### **You can only use a fire extinguisher for grease fires in the following situations:**

- 1) You have a CLASS ABC extinguisher and you already know how to operate it.
- 2) The fire is small and contained in the area where it started.
- 3) The fire department is being called.
- 4) The fire does not obstruct your escape route.
  - Any works on gas equipment and systems may only be carried

out by authorized and qualified persons.

- "Prior to the installation, ensure that the local distribution conditions (nature of the gas and gas pressure) and the adjustment of the appliance are compatible."
- "This appliance is not connected to a combustion products evacuation device. It shall be installed and connected in accordance with current installation regulations. Particular attention shall be given to the relevant requirements regarding ventilation;" See Before installation.
- **"CAUTION:** "The use of gas cooking appliance results in the production of heat and moisture in the room in which it is installed. Ensure that the kitchen is well ventilated: keep natural ventilation holes open or install a mechanical ventilation device (mechanical extractor hood). Prolonged intensive use of the appliance may call for additional ventilation, for example increasing the level of the mechanical ventilation where present."
- Gas appliances and systems must be regularly checked for proper functioning. Please arrange for annual maintenance.
- Clean the gas burners regularly. The flames should be blue and burn evenly.
- Good combustion is required in gas appliances. In case of incomplete combustion, carbon monoxide (CO) might develop. Carbon monoxide is a colorless, odorless and very toxic gas, which has a lethal effect even in very small doses.
- Request information about gas emergency telephone numbers and safety measures in case of gas smell from your local gas provider.
- The appliance and its individual shut-off valve must be disconnected from the gas supply piping system during any pressure testing of that system at test pressures in excess of 1/2 psi (3.5 kPa).
- The appliance must be isolated from the gas supply piping system by closing its individual manual shutoff valve during any pressure testing of the gas supply piping system at test pressures equal to or less than 1/2 psi (3.5 kPa).
- Cooktop burners will not automatically re-ignite in the event of power failure and unignited gas will still be expelled from the burners. Switch off burners im-

mediately whenever a power failure occurs.

- If a burner goes out and gas escapes, open windows and doors. Wait until gas dissipates before using the appliance.
- A manual valve shall be installed in an accessible location in the gas piping external to the appliance for the purpose of turning on or shutting off gas to the appliance.

### **What to do when you smell gas**

- Do not use open flame or do not smoke. Do not operate any electrical buttons (e.g. lamp button, door bell and etc.) Do not use fixed or mobile phones. Risk of explosion and toxication!
- Open doors and windows.
- Turn off all valves on gas appliances and gas meter at the main control valve, unless it's in a confined space or cellar.
- Check all tubes and connections for tightness. If you still smell gas leave the property.
- Warn the neighbours.
- Call the fire-brigade. Use a telephone outside the house.
- Do not re-enter the property until you are told it is safe to do so.

### **Intended use**



**WARNING:** NEVER use this appliance as a space heater to heat or warm a room. Doing so may result in carbon monoxide poisoning and overheating the oven.

- Use this appliance only for its intended use as described in this manual. Never use the appliance for storage.
- All openings in the wall behind the appliance and in the floor under the appliance shall be sealed.
- This appliance is not intended to use at mobile homes, recreational vehicles.
- Do not obstruct the flow of ventilation air.
- The manufacturer shall not be held liable for any damage caused by improper use or handling errors.

### **Disposal**

#### **Packaging material**



**DANGER:**  
Risk of suffocation by the packaging materials!

Packing elements (i.e. plastic bags, polystyrene foam, nails, packing straps, etc.) should not be left around within easy reach of children, as these may cause serious injuries.

The packaging material and transport locks are made from materials that are not harmful to the environment. Please dispose of all parts of the packaging according to environmental standards. This is beneficial to the environment.

**CAUTION:**

If product will be given to someone for personal use or given to someone for second hand use, User manual, product labels, other related documents, mounting parts etc. should be given with product.

**If you do not have the original carton**

Pack the appliance in bubble wrap or thick cardboard and tape it securely in order to prevent damage during transportation.

**Future transportation**

Do not carry out cleaning or maintenance operations on the appliance without having previously disconnected it from the electric power supply.

**NOTICE:**

Do not place other items on the top of the appliance. The appliance must be transported upright.

Store the appliance's original box and transport the appliance in its original carton. Follow the guidance marks that are printed on the carton.

**IMPORTANT:**

Verify the general appearance of your equipment by identifying possible damage during the transportation.

## 2 Preparation

### Tips for saving energy

The following information will help you to use your appliance in an ecological way, and to save energy:

- While cooking your dishes, perform a pre-heating operation if it is advised in the user manual or cooking instructions.
- Defrost frozen dishes before cooking them.
- Use pots/pans with cover for cooking. If there is no cover, energy consumption may increase 4 times.
- Select the burner which is suitable for the bottom size of the pot to be used. Always select the correct pot size for your dishes. Larger pots require more energy.

### Initial use

#### First cleaning of the appliance



The surface might get damaged by some detergents or cleaning materials.

Do not use aggressive detergents, cleaning powders/creams or any sharp objects during cleaning.

Do not use harsh abrasive cleaners or sharp metal scrapers to clean the oven door glass since they can scratch the surface, which may result in shattering of the glass.

1. Remove all packaging materials.
2. Wipe the surfaces of the appliance with a damp cloth or sponge and dry with a cloth.

### Initial heating



#### IMPORTANT:

Smoke and smell may emit for a couple of hours during the initial operation. This is quite normal. Ensure that the room is well ventilated to remove the smoke and smell. Avoid directly inhaling the smoke and the smell that emits.

Heat up the product for about 30 minutes and then switch it off. Thus, any production residues or layers will be burnt off and removed.



#### WARNING

Hot surfaces cause burns!

Product may be hot when it is in use. Never touch the hot burners, inner sections of the oven, heaters and etc. Keep children away.

### 3 How to use the cooktop

#### General information about cooking



##### WARNING

Never fill the pan with oil more than one third of it. Do not leave the cooktop unattended when heating oil. Overheated oils bring risk of fire. **Never attempt to extinguish a possible fire with water!** When oil catches fire, cover it with a fire blanket. Turn off the cooktop if it is safe to do so and call the fire department.



##### CAUTION

Never extend the flame beyond the outer edge of the cooking utensil. A higher flame wastes energy, and increases your risk of being burned by the flame



##### WARNING:

For your safety, top burner flame size must be adjusted so that it does not extend beyond the edge of the cooking utensil. Failure to do so can cause fire hazard.

- Watch the flame, not the knob, as you adjust heat. When rapid heating is desired, the flame size should match the size of the cookware you are using. Flames larger than the bottom of the cookware will not heat faster and may be hazardous.

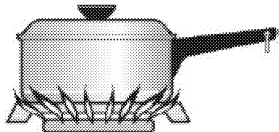
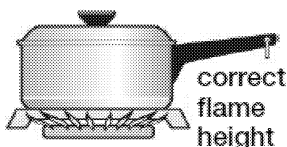

- Before frying foods, always dry them well and gently place into the hot oil. Ensure complete thawing of frozen foods before frying.
- Do not cover the vessel you use when heating oil.
- Place the pans and saucepans in a manner so that their handles are not over adjacent work areas, burners, or the edge of the cooktop to prevent heating of the handles,

risk of fires, spills and burns. Do not place unbalanced and easily tilting vessels on the cooktop.

- Hold the handle of the pan when stirring or turning food. This helps prevent spills and movement of the pan.
- Do not place empty vessels and saucepans on cooking zones that are switched on. They might get damaged.
- Operating a cooking zone without a vessel or saucepan on it will cause damage to the product. Turn off the cooking zones after the cooking is complete.
- As the surface of the product can be hot, do not put plastic and aluminum vessels on it. Such vessels should not be used to keep foods either.
- Use only certain types of glass, heatproof glass, ceramic, earthenware, or other glazed utensils that are suitable for cooktop use.
- Use flat bottomed saucepans or vessels only.
- Put appropriate amount of food in saucepans and pans. Thus, you will not have to make any unnecessary cleaning by preventing the dishes from overflowing.
- Do not put covers of saucepans or pans on cooking zones.
- Place the saucepans in a manner so that they are centered on the cooking zone. When you want to move the saucepan onto another cooking zone, lift and place it onto the cooking zone you want instead of sliding it.
- When disabling gas lockout (some models), make sure the surface controls are set to the OFF position. This will prevent unintended gas flow from the burners.
- Do not use aluminum foil to cover the grates or line any part of the cooktop. Doing so may result in carbon monoxide poisoning, overheating of the cooktop surfaces, or a potential fire hazard.
- Size of the vessel and the flame must match each other. Adjust the gas flames so that

they will not extend the bottom of the vessel and center the vessel on grate.

## Using the cooktop

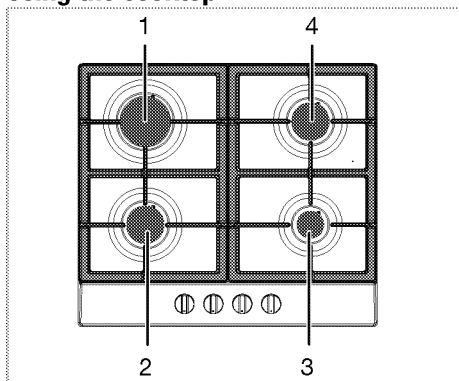

- 1 Rapid burner 23-25 cm (9-10 inches)
- 2 Normal burner 18-23 cm (7-9 inches)
- 3 Auxiliary burner 18-20 cm (7-7.8 inches)
- 4 Normal burner 18-23 cm (7-9 inches) is list of advised diameter of pots to be used on related burners.

 The suggested diameter of pots is given separate use of burner. Do not use all burners at the same time.

 **DANGER:**  
Do not use cooking pans beyond the dimension limits given above. Using larger pans causes risk of carbon monoxide poisoning, overheating of adjacent surfaces and control knobs. Using smaller pans causes your risk of being burned by the flame.

## Igniting the gas burners

Make sure all burners are in their correct locations and fully assembled before attempting to operate any burner.

Gas burners are controlled with gas cooktop knobs.

“HI” symbol indicates the highest cooking power and “LO” symbol corresponds to the lowest cooking power. In “OFF” position, gas is not supplied to the burners.

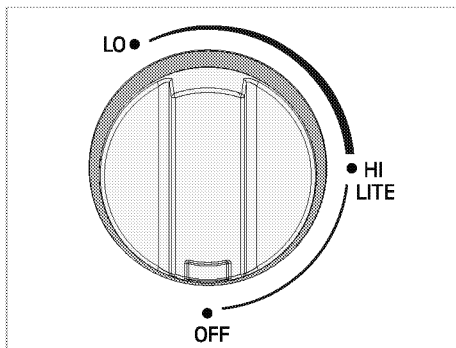

1. Keep burner knob pressed.
2. Turn it counter clockwise to level “LITE”. Gas is ignited with the spark created.
3. Adjust it to the desired cooking power.

 **DANGER:**  
All igniters spark when any single burner is turned on. Do not touch any of the burners when the cooktop is in use.

## Turning off the gas burners

Turn the gas cooktop knobs to “OFF” position.

 **DANGER:**  
If the burner is not ignited within 15 seconds, turn the burner control knob to OFF position. Make sure all burners are in their correct position, control all gas piping against gas leakage and make sure gas supply is not turned off. Wait at least 1 minute and room is well ventilated before trying for ignition again. There is the risk of gas accumulation and explosion!

## Flame characteristics

The burner flame should be soft blue in color and stable with no yellow tips, excessive noise or fluttering. It should burn completely around the burner cap.

**Yellow Flames:**  
Further adjustment is required 

**Yellow Tips on Outer Cones:**  
Normal for LP Gas. 

**Soft Blue Flames:**  
Normal for Natural Gas. 

If the flame is completely or mostly yellow, verify that the regulator is set for the correct gas type and correct injectors are used on the burners. After adjustment, retest.

Some yellow streaking is normal during the initial use. Allow unit to operate 10-15 minutes and re-evaluate before making adjustments.

Foreign particles in the gas line may cause an orange flame during initial use. This should disappear with use. Check burner to make sure port holes are not obstructed and not clogged.

**Call service if;**

1. Any of the burners do not light.
2. Any of the burners continue to burn yellow.



**WARNING:** This product can expose you to chemicals including Nickel (Metallic) which is known to the State of California to cause cancer. For more information go to [www.P65Warnings.ca.gov](http://www.P65Warnings.ca.gov)  
Note: Nickel is a component in all stainless steel and some other metal components.



## 4 Maintenance and care

### General information

Service life of the product will extend and the possibility of problems will decrease if the product is cleaned at regular intervals.

 **DANGER:**  
Disconnect the product from main supply before starting maintenance and cleaning works.  
There is the risk of electric shock!

 **DANGER:**  
Allow the product to cool down before you clean it.  
Hot surfaces may cause burns!

- Keep the appliance area clear and free from combustible materials, gasoline and other flammable vapors and liquids.
- Do not obstruct the flow of combustion and ventilation air.
- Check the burner flames regularly according to **"Flame characteristics"** section in user manual. If flame characteristics is not suitable, clean the burners as described in **"Cleaning the burner/plate"** section.
- Clean the product thoroughly after each use. In this way it will be possible to remove cooking residues more easily, thus avoiding these from burning the next time the appliance is used.
- No special cleaning agents are required for cleaning the product. Use warm water with washing liquid, a soft cloth or sponge to clean the product and wipe it with a dry cloth.
- Always ensure any excess liquid is thoroughly wiped off after cleaning and any spillage is immediately wiped dry.
- Do not use cleaning agents that contain acid or chloride to clean the stainless or inox surfaces. Use a soft cloth with a liquid detergent (not abrasive) to wipe those parts clean, paying attention to sweep in one direction.

 The surface might get damaged by some detergents or cleaning materials.  
Do not use aggressive detergents, cleaning powders/creams or any sharp objects during cleaning.

 Do not use steam cleaners to clean the appliance as this may cause an electric shock.

### Cleaning the burner/plate

#### Gas cooktop

1. Remove and clean the burner grates and burner caps and clean them.
2. Clean the cooktop.
3. Refit the burner caps and make sure that they are seated correctly.
4. When installing the pan supports, pay attention to place the burner grates so that the burners are centered.

#### Burner caps

After cleaning make sure the burner caps are placed properly. See below figure.

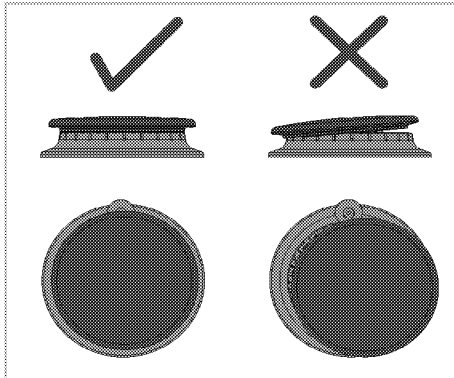

#### Grates

The cooktop has three different grates. These grates have specific position from each other. For maximum stability, these grates should only be used in their proper position. Because of the varied burner sizes, the side grates cannot be exchanged nor can any of the grates be rotated front to back.

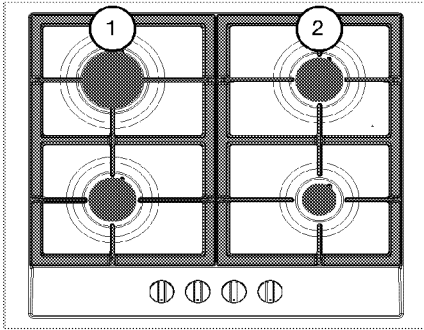

Grates should be cleaned regularly and, of course, after spills. Wash them in hot, soapy water and rinse with clean water.

After cleaning make sure the burner grates are placed properly.

### **Cleaning the control panel**

Clean the control panel and knobs with a damp cloth and wipe them dry.



Do not remove the control buttons/knobs to clean the control panel.  
Control panel may get damaged!

# 5 General information

## Overview

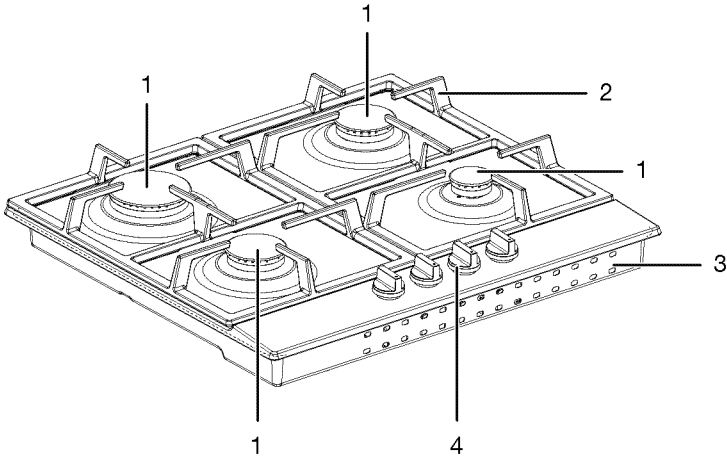

- 1 Burners
- 2 Grates

- 3 Base cover
- 4 Control panel

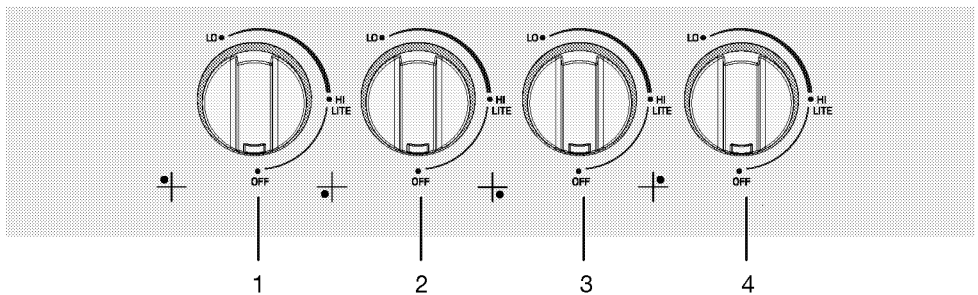

- 1 Rapid burner Rear left
- 2 Normal burner Front left

- 3 Auxiliary burner Front right
- 4 Normal burner Rear right

## Technical specifications

<b>Voltage / frequency</b>	<b>120V ~ 60 Hz 1A</b>
Total gas consumption	27 500 BTU/h / 23 500 BTU/h
Cable type / section/length	DTR 4x10 AWG / max. 6 ft
Fuse protection	Min. 15 A
Gas type / pressure	<b>Natural Gas NAT 4" / LP Gas 11"</b>
External dimensions (height / width / depth)	2" 5/16 (59mm) / 22" 13/16 (580 mm) / 20" 1/16 (510 mm)
Installation dimensions (width / depth)	22" 1/16 (560 mm) / 19" 5/16 (490 mm)
<b>Burners</b>	
Front left	<b>Normal burner</b>
Power	7000 BTU/h / 5000 BTU/h
Rear left	<b>Rapid burner</b>
Power	10000 BTU/h / 10000 BTU/h
Front right	<b>Auxiliary burner</b>
Power	3500 BTU/h / 2500 BTU/h
Rear right	<b>Normal burner</b>
Power	7000 BTU/h / 6000 BTU/h

This appliance can be used with LP gas and Natural gas. It is shipped from the factory adjusted for use with 4" w.c natural gas. Conversion orifices are located in conversion kit. Follow the instructions packaged with the orifices for gas conversion.



Technical specifications may be changed without prior notice to improve the quality of the product.



Figures in this manual are schematic and may not exactly match your product.



Values stated on the product labels or in the documentation accompanying it are obtained in laboratory conditions in accordance with relevant standards. Depending on operational and environmental conditions of the product, these values may vary.

## Injector table



### WARNING:

This product can be converted to LP Gas. Gas conversion must always be performed by Authorized Service Agents.

According to the gas type that will be used, the correct injector type must be used. Please refer to the LPG/NG table below.

Position cooktop zone	Rear left	Front right	Rear right	Front left
Gas type / Gas pressure				
Natural Gas 4"	1.55 mm	0.90 mm	1.25 mm	1.25 mm

Position cooktop zone	Rear left	Front right	Rear right	Front left
Gas type / Gas pressure				
LP Gas 11"	0.87 mm	0.50 mm	0.72 mm	0.72 mm

## 6 Troubleshooting

### **Burner have yellow or yellow-tipped flames.**

- The combustion quality of burner flames needs to be determined visually >>> *Verify that the regulator is set for the correct gas type and correct injectors are used on the burners. After adjustment, retest.*

### **Control knobs will not turn.**

- Knob is not pushed down. >>> *To turn from the OFF position, push the knob down and then turn.*

### **Burner flames are very large or have yellow.**

- Improper air to gas ratio >>> *If cooktop is connected to LP gas, contact the person who installed your cooktop or made the conversion.*

### **Burners do not light**

- Plug on cooktop is not completely inserted in the electrical outlet. >>> *Make sure electrical plug is plugged into a live, properly grounded outlet.*
- Gas supply not connected or turned on. >>> *See the Installation Manual that came with your cooktop.*
- Burner part not replaced correctly. >>> *Make sure the burner caps are placed properly.*

### **Burners are not burning properly or at all.**

- Burners are dirty. >>> *Clean burner components.*
- Burners are wet. >>> *Dry the burner components.*
- Burner cap is not mounted safely. >>> *Mount the burner cap properly.*
- Gas valve is closed. >>> *Open gas valve.*



Consult the Authorised Service Agent or technician with licence or the dealer where you have purchased the product if you can not remedy the trouble although you have implemented the instructions in this section. Never attempt to repair a defective product yourself.

## **7 BEKO US RESIDENTIAL PRODUCT WARRANTY**

The warranties provided by Beko in these statements only apply to Beko appliance sold to the original purchaser or homeowner in the US (Including Alaska, Hawaii, Puerto Rico and the US Virgin Islands) and The Cayman Islands

The factory warranty applies only to products purchased through an authorized dealer or authorized reseller. Go to [www.bekoappliances.com/where-to-buy](http://www.bekoappliances.com/where-to-buy) for a list of authorized dealers. Products purchased through non-authorized dealers and wholesalers will not be covered under the manufactures warranty

The warranty is not transferable. To obtain warranty service, please contact your dealer or contact us at

<https://www.bekoappliances.com/support/beforecallcenter/>  
You will need your product model number, serial number, retailer name and address, where purchased and purchase date / installation date. This warranty gives you specific legal rights, and you may also have other rights which vary from state to state. Also, please make sure you register your product for warranty at:  
<https://www.bekoappliances.com/product-registration/>

### **2 year (\*) full warranty from date of first Installation (All Beko Products)**

Beko will repair or replace at no cost to the consumer any defective parts product if used under normal household conditions

**(Warranty is void if the product is used commercially e.g., bed + breakfast, nursing home etc.). Service must also be performed by an authorized Beko service agency. (Cosmetic defects must be reported within 10 business days from installation). 1 year warranty on the accessories is for the parts only and does not include labor.**

### **3rd thru 5th year (\*, \*\*) Sealed System Warranty on refrigerators - Parts Only**

Beko will provide (No Charge) any compressor, evaporator, condenser and filter Dryer to the consumer if material defects or workmanship have caused the damage or failure of these components.

(Trip and Labor charges are the responsibility of the consumer)

### **3rd thru 10th year (\*, \*\*) ProSmart™ Inverter Motor on Dishwashers – Part Only**

Beko will provide (No Charge) a ProSmart Inverter Main Wash Motor if material defects or workmanship have caused the damage or failure of this component.

(Trip and Labor charges are the responsibility of the consumer)

### **Disclaimers of warranties and exclusions:**

**Warranty does not cover service costs by an authorized service agent to correct installation, electrical problems or educational instruction on the use of the electric and gas ranges. The warranty also does not cover defects or damage caused by an act of God (such as storms, floods, fires, mudslides, etc.), damage cause by use of the electric and gas ranges for purposes other than those for**

**which it was designed, misuse, abuse, accident, alteration, improper installation, maintenance, travel fees, service calls outside normal service hours, pick up and delivery, any food loss due to product failure, unauthorized service work or work.**

**This product is fully tested and went through official quality assurance inspections before leaving the original manufacturing site. Warranty terms for this Beko household appliance is not valid if the product is altered, tampered, modified, additional parts assembled, fixed and re-packed by an authorized distributor, servicer, a third party retailer, reseller or by any other unauthorized person(s).**

**TO THE EXTENT PERMITTED BY LAW, THIS WARRANTY IS IN LIEU OF ALL OTHER EXPRESSED AND IMPLIED WARRANTIES, INCLUDING THE IMPLIED WARRANTIES OF MERCHANTABILITY AND FITNESS FOR A PARTICULAR PURPOSE. BEKO UNDERTAKES NO RESPONSIBILITY FOR THE QUALITY OF THIS PRODUCT EXCEPT AS OTHERWISE PROVIDED IN THIS WARRANTY STATEMENT. BEKO ASSUMES NO RESPONSIBILITY THAT THE PRODUCT WILL BE FIT FOR ANY PARTICULAR PURPOSE FOR WHICH YOU MAY BE BUYING THIS PRODUCT, EXCEPT AS OTHERWISE PROVIDED IN THIS WARRANTY STATEMENT.**

**Beko does not assume any responsibility for incidental or consequential damages. Such damages include, but are not limited to, loss of profits, loss of savings or revenue, loss of use of the electric and gas ranges or any associated equipment, cost of capital, cost of any substitute equipment, facilities or services, downtime, the claims of third parties, and injury to property. Some states do not allow the exclusion or limitation of incidental or consequential damages, so the above limitations or exclusion may not apply to you.**

**(\*) Installation date shall refer to either purchase date or 5 business days after delivery of the product to the home, whichever is later.**

**(\*\*) Parts replaced will assume the identity of the original parts + their original warranty.**

**No Other Warranties. This Warranty Statement is the complete and exclusive warranty from the manufacturer. No employee of Beko or any other party is authorized to make any warranty statements in addition to those made in this Warranty Statement.**

**Please keep this warranty card, user manual and your sales slip for future reference.**

### **HOW TO CONTACT BEKO**

Please contact Beko US at 1 (888) 352-2356 and select option 2 for customer service

### **HOW TO GET SERVICE**

Please contact your authorized Beko dealer or visit [www.bekoappliances.com](http://www.bekoappliances.com) to locate and get information for the closest authorized Beko service center.

