



Built-in Oven

User Manual

IMPORTANT

Installer should leave these instructions with appliance.

Consumer should read these instructions before using the appliance and should retain them for future reference.

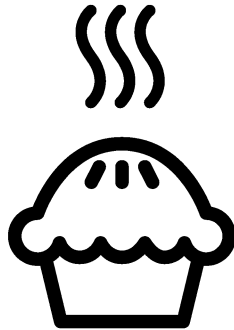

WOS30100SS-WOS30200CF

EN

285.6001.22/R.Aj/23.09.2020/3-1

7735687907-7735687912

IMPORTANT SAFETY INSTRUCTIONS

READ AND SAVE THESE INSTRUCTIONS



WARNING: Read all safety instructions before using the product. If the information in this manual is not followed exactly, a fire or explosion may result causing property damage, personal injury or death.



IMPORTANT:

This appliance is intended for normal household use only. It is not approved for outdoor or other non-household uses (including sea or air-going vessels). See the Statement of Limited Warranty. If you have any questions, contact the manufacturer.

Do not repair or replace any part of the appliance unless specifically recommended in this manual. Refer all servicing to a factory authorized service center.

Explanation of symbols

Throughout this User Manual the following symbols are used:



important information or useful hints about usage.



Warning for hazardous situations with regard to life and property.



Warning for electric shock.



Warning for risk of fire.



Warning for hot surfaces.

DANGER indicates a hazardous situation which, if not avoided, will result in death or serious injury.

WARNING indicates a hazardous situation which, if not avoided, could result in death or serious injury.

CAUTION indicates a hazardous situation which, if not avoided, could result in minor or moderate injury.

NOTICE is used to address practices not related to physical injury.

 **Please read these instructions before installation
or using your appliance!**

Dear Customer,

We would like you to obtain best performance with your product that has been manufactured in modern facilities and passed through strict quality control procedures.

Therefore, we advise you to read through this user manual carefully before using your product and keep it for future reference. If you hand over the product to someone else, deliver the user manual as well.

The user manual will help you use the product in a fast and safe way.



IMPORTANT:

Save these instructions for the local electrical inspectors use.



IMPORTANT:

This product can only be used in the rooms which incorporates a properly adjusted and functioning Carbon Monoxide sensor. Make sure the Carbon Monoxide sensor works properly and its maintenance done frequently. Carbon Monoxide sensor should be installed maximum 6.5 feet away from the product.

The instructions will help you to operate the appliance quickly and safely.

- Upon delivery, please check that the appliance is not damaged. If you note any transport damage, please contact your point of sale immediately and do not connect and operate the appliance!
- Before you connect and start using the appliance, please read this manual and all enclosed documents. Please note in particular the safety instructions.
- Keep all documents so that you can refer to the information again later on.
Please keep your receipt for any repairs which may be required under warranty.
- When you pass on the appliance to another person, please provide all documents with it including original date of purchasing. (The warranty does not convey if the unit is sold).
- If you should decide not to use this appliance any longer (or decide to substitute an older model), before disposing of it, it is recommended that it be made inoperative in an appropriate manner in accordance to health and environmental protection regulations, ensuring in particular that all potentially hazardous parts be made harmless, especially in relation to children who could play with old appliances.

TABLE OF CONTENTS

1 Safety Instructions - Read before use

6

Basic safety instructions	6
Safety for children	10
Safety when working with electricity	11
Intended use.....	11
Disposal	12
Packaging material.....	12
Future transportation	12

2 Installation

13

Before installation	13
---------------------------	----

3 Preparation

20

Tips for saving energy	20
Initial use.....	20
Setting the time	20
First cleaning of the appliance.....	20
Initial heating	21

4 How to operate the oven

22

General information on baking, roasting and broiling	22
How to use the electric oven	22
How to operate the oven control unit	31

5 Maintenance and care

36

General information.....	36
Cleaning the control panel	36
Cleaning the oven	36
Removing the oven door	37
Replacing the oven lamp.....	38

6 General information

39

Overview.....	39
Technical specifications.....	39
Package contents.....	40

7 Troubleshooting



41

8 BEKO US RESIDENTIAL PRODUCT WARRANTY

42



1 Safety Instructions - Read before use



Basic safety instructions

- The manufacturer reserves its right to make changes in the technical specifications in order to improve the appliance quality without any prior notice. Figures included in this manual are for schematic purpose only and may not match exactly with your appliance. Values stated on the markings of the appliance or in other printed documents supplied with the appliance are obtained under laboratory conditions as per relevant standards. These values may vary according to the usage of the appliance and ambient conditions.
- This appliance is not intended for use by persons (including children) with reduced physical, sensory or mental capabilities, or lack of experience and knowledge, unless they have been given supervision or instruction concerning use of appliance by a person responsible for their safety.
- Children should be supervised to ensure that they do not play with the appliance.
- Proper installation - Be sure your appliance is properly installed and grounded by a qualified technician
- If the supply cord damaged, it must be replaced by a special cord or assembly available from the manufacturer or its service agent or similarly qualified persons.
- ** WARNING:** Never use your appliance for warming or heating the room.
- User servicing - Do not repair or replace any part of the appliance unless specifically recommended in the manual. All other servicing should be referred to a qualified technician.
- Wear proper apparel - loose-fitting or hanging garments should never be worn while using the appliance.
- Use care when opening door- let hot air or steam escape before removing or replacing food.
- ** CAUTION:** Placement of oven racks -always place oven racks in desired location while oven is cool. If rack must be moved while oven is hot, do not let potholder contact hot heating element in oven.
- ** CAUTION:** Use only dry potholders- moist or damp potholders on hot surfaces may

result in burns from steam. Do not let potholder touch hot heating elements.

Do not use a towel or other bulky clothes.





- Do not heat unopened food containers. Pressure could build up and the container could burst, causing an injury.
- Keep oven vent ducts unobstructed.
- Ensure that no flammable materials are adjacent to the appliance as the sides become hot during use.
- Do not place baking trays, dishes or aluminum foil directly onto the bottom of the oven. The heat accumulation might damage the bottom of the oven.
-  **CAUTION:** Do not use aluminum foil to line drip pans or anywhere in the oven, except as described in this manual. Foil can trap heat or melt, resulting in damage to the product and a shock or fire hazard.
-  **WARNING:** Keep all ventilation slots clear of obstructions.
- The manufacturer declines all liability for injury to persons or damage to property caused by incorrect or improper use of the appliance.

- Do not use the oven with front door glass removed or broken.
-  **WARNING:** Do not use water on grease fires. If there is a fire in the oven during baking, smother the fire by closing the oven door and turning the oven off or by using a multi-purpose dry chemical or foam-type fire extinguisher.
-  **WARNING:** Rear surface of the oven gets hot when it is in use. Electric connection should not touch the rear surface, otherwise the mains cable may get damaged. Do not trap the mains cable between the hot oven door and frame. Do not route the mains cable over the hot cooking section. Otherwise, cable insulation may melt and cause fire as a result of short circuit.
- Never wear loose-fitting or hanging garments while using the appliance. Be careful when reaching for items stored in cabinets over the oven. Flammable material could be ignited if brought in contact with hot surfaces or heating elements and may cause severe burns.
- Pulling out the rack to the stop-lock is a convenience in lifting heavy foods. It is also a precaution against burns from









touching hot surfaces of the door or oven walls.







-  **WARNING:** Do not use the oven to dry newspapers. If overheated, they can catch on fire.
-  **WARNING:** Storage in or on Appliance- Flammable materials should not be stored in an oven or near surface units.
-  **WARNING:** Do not leave paper products, cooking utensils or food in the oven when not in use.
-  **WARNING:** After broiling, always take any broiler pan out of the oven and clean it. Leftover grease in a broiler pan can catch fire next time you use the pan.
- Check that all controls on the appliance are switched off after use.
-  **WARNING:** **"Do not touch heating elements or interior surfaces of oven** - Heating elements may be hot even though they are dark in color. Interior surfaces of an oven become hot enough to cause burns. During and after use, do not touch, or let clothing or other flammable materials contact heating elements or interior surfaces of oven until they have had sufficient time to cool. Other

surfaces of the appliance may become hot enough to cause burns - among these surfaces are oven vent openings and surfaces near these openings, interior surfaces of the oven cavity, oven doors, and window."

-  **WARNING:** Accessible parts may become hot during use. Young children should be kept away.
-  **CAUTION:** Do not use harsh abrasive cleaners or sharp metal scrapers to clean the oven door glass since they can scratch the surface, which may result in shattering of the glass.
-  **WARNING:** This appliance can be used by children aged from 8 years and above and persons with reduced physical, sensory or mental capabilities or lack of experience and knowledge if they have been given supervision or instruction concerning use of the appliance in a safe way and understand the hazards involved.
- Children shall not play with the appliance. Cleaning and user maintenance shall not be made by children without supervision.
-  **WARNING:** The appliance and its accessible parts become hot during use. Care should be

taken to avoid touching heating elements. Children less than 8 years of age shall be kept away unless continuously supervised.

-  **WARNING:** Only use the connection cable specified in the “Technical specifications”. If the supply cord damaged, it must be replaced by a special cord or assembly available from the manufacturer or its service agent or similarly qualified persons in order to avoid a hazard.
-  **WARNING:** During self-cleaning, surfaces may become hotter than with standard use. Keep children away.
-  **CAUTION:** Only use the temperature probe recommended for this oven.
-  **CAUTION:** Use care when opening door- let hot air or steam escape before removing or replacing food.
- Do not heat closed food containers and glass jars. Pressure that may build-up in the jar can cause it to burst.
-  **WARNING:** Food Poisoning Hazard: Do not let food sit in oven for more than 1 hour before or after cooking. Doing so can result in food poisoning or sickness.
-  **WARNING:** To avoid permanent damage to the oven bottom finish do not line the oven bottom with any type of foil or liner.
-  **CAUTION:** If a wet sponge or cloth is used to wipe spills on a hot cooking area, be careful to avoid steam burn. Some cleaners can produce noxious fumes if applied to a hot surface. Utensil handles should be turned inward and not extend over adjacent surface units. To reduce the risk of burns, ignition of flammable materials, and spillage due to unintentional contact with the utensil, the handle of a utensil should be positioned so that it is turned inward, and does not extend over adjacent surface units.
-  **CAUTION:** Do not store or use flammable materials in an oven, including paper, plastic, pot holders, linens, wall coverings, curtains, drapes and gasoline or other flammable vapors and liquids.
- Never use when judgment or coordination is impaired by the use of alcohol and/or drugs.
- Do not operate the appliance if it is defective or shows any visible damage.

- Do not carry out any repairs or modifications on the appliance. However, you may remedy some malfunctions; see Troubleshooting.
- Be careful when using alcoholic drinks in your dishes. Alcohol evaporates in high temperatures and may cause fire since it will catch fire when it gets in contact with hot surfaces.
-  **WARNING:** Keep appliance area clear and free from combustible materials, gasoline, and other flammable vapors.
-  **WARNING:** Keep the oven free from grease buildup. Grease in the oven may ignite.
- Only authorized replacement parts may be used in performing service on the range. Replacement parts are available from factory authorized parts distributors. Contact the nearest parts distributor in your area.
-  **WARNING:** Use this appliance for its intended purpose as described in this owner's manual.
-  **CAUTION:** Always use heat-resistant gloves when putting or removing the dishes into/from your oven.
-  **CAUTION:** Always use Only Dry Potholders or heat-resistant gloves when putting or removing the dishes into/from your oven. Do not let potholder touch hot heating elements.
-  **WARNING:** Avoid scratching or impacting glass doors, cook tops or control panels. Doing so may lead to glass breakage. Do not cook on a product with broken glass. Shock, fire or cuts may occur.
-  **IMPORTANT:** Call the authorized service for installation of the appliance to be used. After this procedure, guarantee period will be started.



Safety for children

- **WARNING:** Stepping, leaning or sitting on the door or drawers of this range can result in serious injuries and also cause damage to the range. Do not allow children to climb or play around the range. The weight of a child on an open door may cause the range to tip, resulting in serious burns or other injury.
- Accessible parts may be hot when the broil is in use. Young children should be kept away.
- Surface units may be hot even though they are dark in color. Areas near surface units may become hot enough to cause burns. During and after use, do not touch or let clothing or other

flammable materials contact surface units until they have had sufficient time to cool. Among these areas are (identification of areas) for example, the cook-top and surfaces facing the cook-top.

-  **WARNING:** Do not store items of interest to children in the cabinets above the range or on back guard of a range. Children climbing on the range to reach items could be seriously injured.
- The packaging materials will be dangerous for children. Keep the packaging materials away from children. Please dispose of all parts of the packaging according to environmental standards.
- Do not leave children alone - children should not be left alone or unattended in area where appliance is in use. They should never be allowed to sit or stand on any part of the appliance.

Safety when working with electricity

-  **WARNING:** Before installing, turn power OFF at the service panel. Lock service panel to prevent power from being turned ON accidentally.
-  **WARNING:** Personal injury or death from electrical shock may occur if the range is not

installed by a qualified installer or electrician.

- Any additions, changes or conversions required in order for this appliance to satisfactorily meet the application needs must be made by a qualified technician.
- Before performing any service, unplug the range or disconnect the power supply at the household distribution panel by removing the fuse or switching off the circuit breaker.
- Any work on electric equipment and systems may only be carried out by authorized qualified persons.
- In case of any damage, switch off the appliance and disconnect it from the main supply by removing the fuse or switching off the circuit breaker.
- Ensure that the fuse rating is correct.
- Do not operate the appliance barefooted.
- Never touch the appliance with wet hands or feet.
- Do not soak removable heating elements. Heating elements should never be immersed in water.

Intended use

- This product is designed for domestic cooking purposes only.

It is not designed for any other uses such as room heating or drying towels and dish cloths. Commercial use will void the guarantee.

- All openings in the wall behind the appliance and in the floor under the appliance shall be sealed.
- This appliance is not intended to use at mobile homes, recreational vehicles.
-  **WARNING:** Do not obstruct the flow of ventilation air.
- The manufacturer shall not be held liable for any damage caused by improper use or handling errors.
- The appliance can be used for defrosting, baking, roasting and broiling food.

Disposal

Packaging material

	<p>DANGER: Risk of suffocation by the packaging materials!</p> <p>Packing elements (i.e. plastic bags, polystyrene foam, nails, packing straps, etc.) should not be left around within easy reach of children, as these may cause serious injuries.</p>
---	--

The packaging material and transport locks are made from materials that are not harmful to the environment. Please dispose of all parts of the

packaging according to environmental standards. This is beneficial to the environment.

	<p>CAUTION: If product will be given to someone for personal use or given to someone for second hand use, User manual, product labels, other related documents, mounting parts etc. should be given with product.</p>
---	--

Future transportation

Do not carry out cleaning or maintenance operations on the appliance without having previously disconnected it from the electric power supply.

	<p>NOTICE: Do not place other items on the top of the appliance. The appliance must be transported upright.</p>
---	--

Store the appliance's original box and transport the appliance in its original carton. Follow the guidance marks that are printed on the carton.

	<p>IMPORTANT: Verify the general appearance of your equipment by identifying possible damage during the transportation.</p>
---	--

To prevent the wire shelf and tray inside the oven from damaging the oven door, place a strip of cardboard onto the inside of the oven door that lines up with the position of the trays. Tape the oven door to the side walls.

If you do not have the original carton

Pack the appliance in bubble wrap or thick cardboard and tape it securely in order to prevent damage during transportation.

2 Installation



IMPORTANT:

The product should only be installed by suitably qualified electricians.

- Preparation of location and electrical installation for the product is under customer's responsibility.
- The product must be installed in accordance with all local electrical regulations.
- Prior to installation, visually check if the product has any defects on it. If so, do not have it installed.
- Damaged products cause risks for your safety.

Before installation

The appliance is intended for installation in commercially available kitchen cabinets. A safety distance must be left between the appliance and the kitchen walls and furniture. See figure (values in mm).

- Surfaces, synthetic laminates and adhesives used must be heat resistant.
- Kitchen cabinets must be set level and fixed.
- If there is a drawer beneath the oven, a shelf must be installed between oven and drawer.
- The following installation drawings are representational and may not match exactly with your appliance
- Product guarantee will be valid after proper installation. Manufacturer will not be responsible any hazard or damage of improper installation or usage.
- Don't pull the oven on the floor during transportation in order to avoid damages on the floor surface. Always carry your product by using two or more people.
- Remove all shipping materials inside or outside of the oven.
- Remove all equipments inside of the oven including the printed documents.



Important notes to the consumer

Keep this manual for future reference.

- As when using any range generating heat, there are certain safety precautions you should follow. These are listed in the front of this manual. Read and follow carefully.
- Be sure your range is installed and grounded properly by a qualified installer or service technician.



Important notes to the installer

Read manual before installing the range.

Observe all governing codes and ordinances.

Be sure to leave these instructions with the consumer.

Be sure your range is installed and grounded properly by a qualified installer or service technician.



IMPORTANT:

Before installing the range in an area covered with linoleum or any other synthetic floor covering, make sure the floor covering can withstand heat at least 90°F (32.2°C) above room temperature without shrinking, warping or discoloring.

Installation Conditions

- All dimensions given in this manual are in inches and millimeters.
- The oven has dimensions given in Figure A.
- The product should be installed to the cabinets with the dimensions specified for different types of locations.
- The first step of the installation is to check the dimensions of your existing cut out. For new furniture orders, these dimensions should be considered.
- All cabinet works, if necessary should be completed before installation and all remains of the work should be cleaned before installation.
- Kitchen cabinet should be fixed and level so that the fix oven can't tilt.
- The board of the cabinet on which the oven to placed should withstand 220 lbs (100 kg) or more.
- If there is a drawer beneath the oven, a shelf must be installed between the oven and drawer.

Installation Under a Countertop

- The cabinet should have the dimensions in Figure B.
- Base plate dimension must $\frac{3}{4}$ " (19 mm).
- Junction box may be located in adjacent cabinet.

Installation in a High Cupboard

- The cabinet should have the dimensions in Figure C.

- Junction box may be located in adjacent cabinet.

Flush Installation in a High Cupboard

- The cabinet should have the dimensions in Figure D.
- Junction box may be located in adjacent cabinet.
- For flush installation you need two reveal cleats fixed like in figure E.

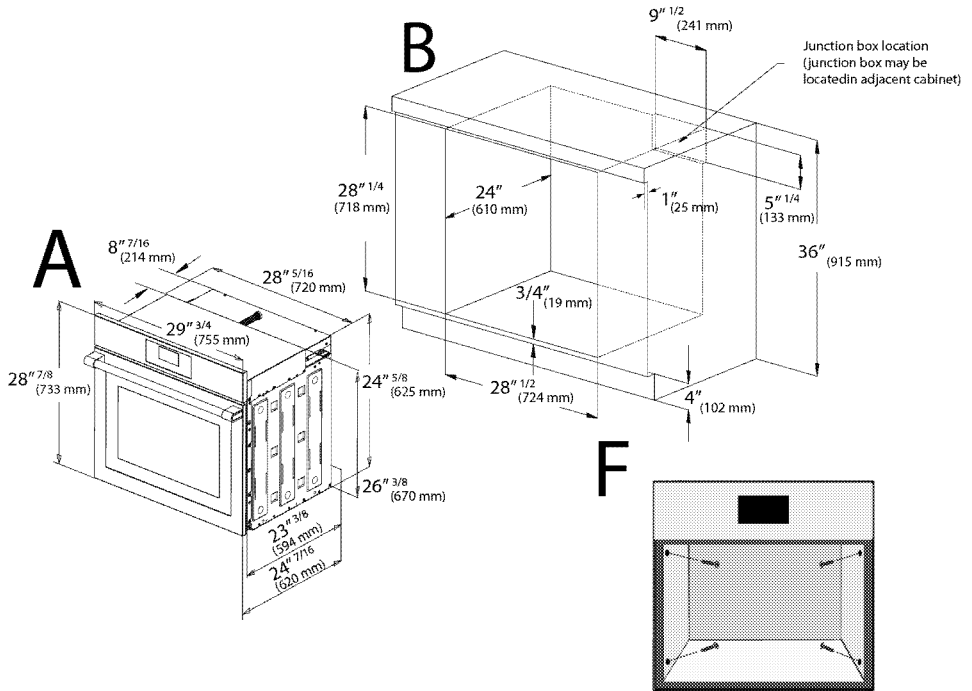

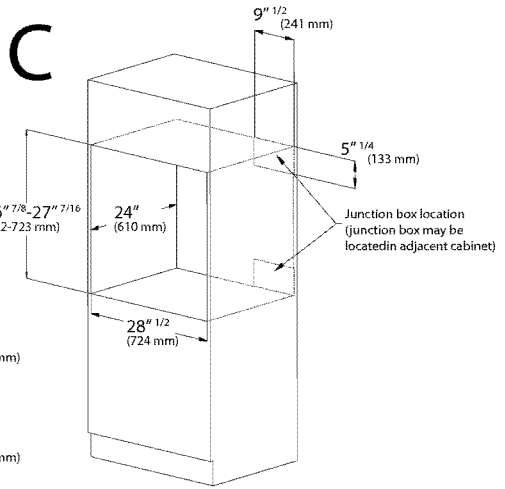
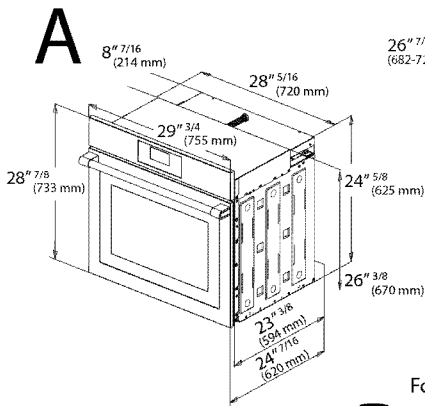

For Flush Fitted Installation

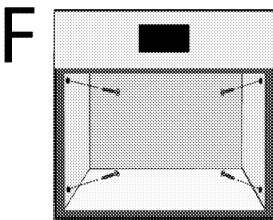
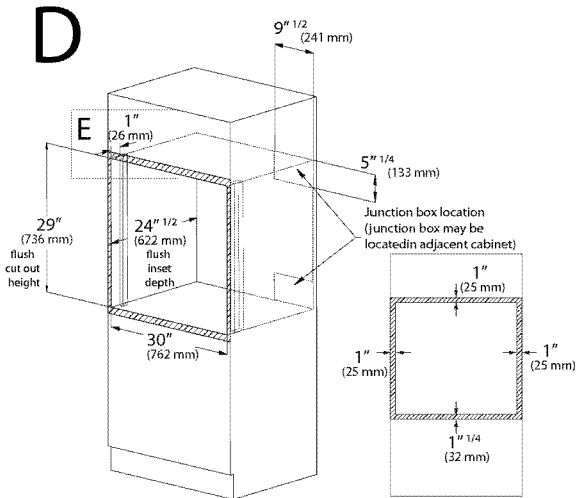
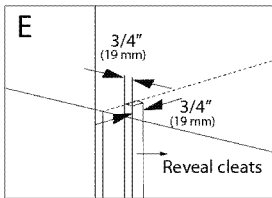

Positioning and Fixing the Oven

- Use safety gloves before carry the oven.
- Put the oven into the cabinet by two or more people.
- Don't carry or lift the oven from its handle or front panel.

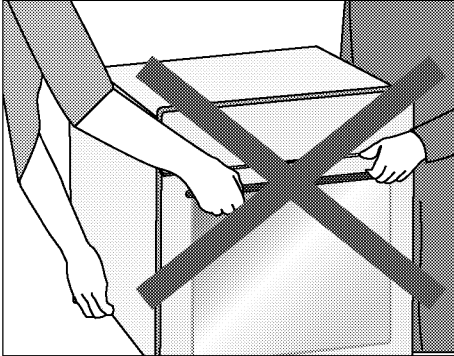

- Carry the oven like in the figures below.

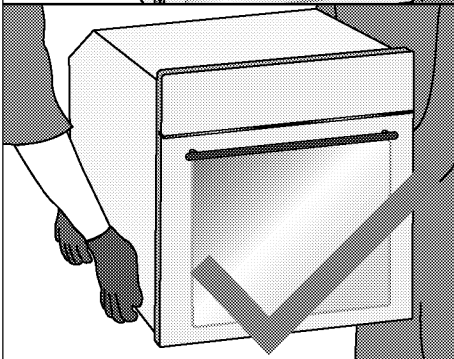
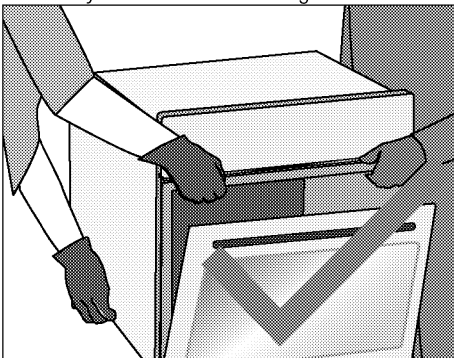

- Push the oven into the cabinet from the seal area (Z). Don't push against the control panel or edges.

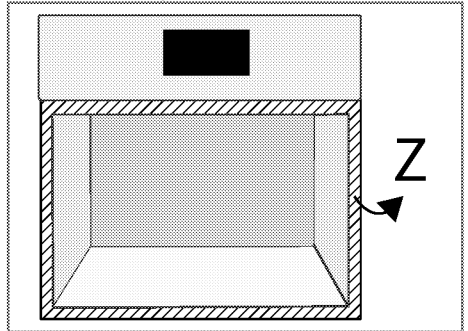

- Be sure that oven frame and cabinet front frame overlapped perfectly.
- The supply cord must not be clamped, bent, or squeezed during positioning the oven into the cabinet. If there is a damage on the supply cord, it must be replaced by a qualified electrician with a new supply cord with the technical properties listed in the user manual.
- Fix the oven to the cabinet using the screws provided. Screws should be inserted through installation mounted on the side frames of the oven (see Figure F). Do not over tighten the screws.
- After installation, check the screws are securely tightened and the product can't be moved. If the oven is not installed and tightened properly, there is a risk of tip over.

Final Check

- Turn on the power source after installing the oven.
- Refer to the user manual for first usage of the oven.
- Check functions.

Installation and connection



IMPORTANT: **Material damage!**

The door and/or handle must not be used for lifting or moving the appliance.

If the appliance has wire handles, push the handles, back into the side walls after moving the appliances.

- Carry the appliance with at least two persons.
- For installation the appliance must be connected in accordance with all local electrical and/or gas regulations.



DANGER **Electrical shock hazard!**

Do not use an adapter plug, an extension cord, or remove grounding prong from electrical power cord, have a qualified electrician install an outlet near the appliance. Failure to follow this warning can cause serious injury, fire or death.

- Contact a qualified installer or contractor to determine the proper method for drilling holes through the wall or floor material (such as ceramic tile, hardwood, etc.)
- Do not slide the unit across an unprotected floor.
- Failure to follow these instructions may result in damage to wall or floor coverings.
- The California Safe Drinking water and Toxic Enforcement Act requires the Governor of California to publish a list of substances known to the State of California to cause cancer, birth defects, or other reproductive harm, and requires businesses to warn of potential exposure to such substances.



WARNING: This product can expose you to chemicals including Nickel (Metallic) which is known to the State of California to cause cancer. For more information go to www.P65Warnings.ca.gov
Note: Nickel is a component in all stainless steel and some other metal components.



IMPORTANT:

This product contains a chemical known to the state of California to cause cancer, birth defects, or other reproductive harm.

Installation instructions

- Electrical connections:
- Attention Installer
- All electric wall ovens must be hard wired (Direct wired) into an approved junction box. A plug and receptacle is not permitted on these product. Do not shorten the flexible conduit. The conduit strain relief clamp must be securely attached to the junction box and the flexible conduit must be securely attached to the clamp. If the flexible conduit will not fit within the clamp, do not install the oven until a clamp of the proper size is obtained.

Electrical Connection



IMPORTANT:

Save for the local electrical inspector's use.



IMPORTANT:

Any work on electric equipment and systems may only be carried out by authorized qualified persons.

- It is important that the place of installation has an adequate electrical system. Before installing the oven, it should be controlled by a qualified electrician and approved that the addition of the oven will not overload the branch circuit on which it is to be installed. The mains supply data should correspond to the data specified on the type plated. Type plate can be reached by opening the front door of the oven.
- The unit should be installed and connected in accordance with national and local regulations.
- The cable for further replacements should correspond to the specifications listed in the user manual.
- Turn off the power source before installing the oven. The product should not be connected to the mains before the installation completed.

Connection to the main supply



IMPORTANT:

Electrical installation should comply with national and local codes.



IMPORTANT:

This appliance must be grounded!



WARNING

Avoid fire hazard or electrical shock. Do not use an adapter plug, an extension cord, or remove grounding prong from electrical power cord, have a qualified electrician install an outlet near the appliance. Failure to follow this warning can cause serious injury, fire or death.



WARNING: Power supply!

The main power supply lead must not be clamped, bent or trapped or come into contact with hot parts of the appliance. If the main power supply is damaged, it must be replaced by a qualified electrician.

Be sure your appliance is properly installed and grounded by a qualified technician. Ask your dealer to recommend a qualified technician or an authorized repair service.

This appliance is manufactured with a green GROUND wire connected to the oven chassis. After making sure that the power has been turned off, connect the flexible conduit from the oven to the junction box using a U.L. listed conduit connector. Figures A and B and the instructions provided below present the most common way of connecting the ovens. Your local codes and ordinances, of course, take precedence over these. Complete electrical connections according to local codes and ordinances.



WARNING

Risk of Electric Shock or Fire. Grounding through the neutral conductor is prohibited for new branch circuit installations (1996 NEC), mobile homes, and recreational vehicles, or in an area where local codes prohibit grounding through the neutral conductor.

For installations where grounding through the neutral conductor is prohibited:

- Disconnect the ground from the neutral at free end of conduit;
- Use grounding terminal of lead to ground unit; and
- Connect neutral terminal or lead to branch circuit neutral in usual manner.

Wire branch circuit (for US only)

Figure A

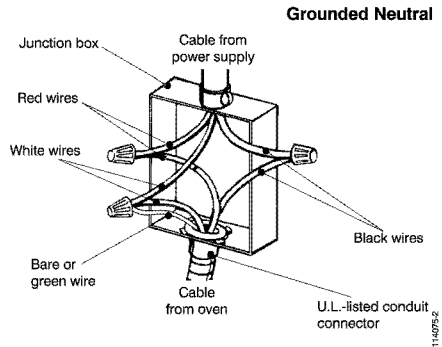

Refer to Figure A, where local codes allow the connection of GROUND wire from the oven to the branch circuit NEUTRAL wire (gray or white colored wire):

- If local codes permit, connect the green GROUND wire from the oven and white wire form the oven to the branch circuit NEUTRAL wire (gray or white colored wire).
- Connect the red and black leads from the oven to the corresponding leads in the junction box.

Wire branch circuit (for US and Canada)

Figure B

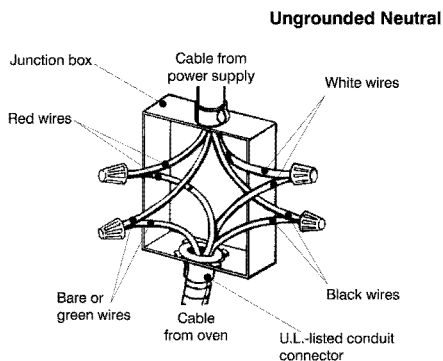

Refer to Figure B:

- Disconnect ground from neutral at free end of conduit.
- Connect the green GROUND wire from the oven to the GROUND wire in the junction box (bare or green colored wire).
- Connect the red and black leads from the oven to the corresponding leads in the junction box.
- Connect the white wire from the oven to the NEUTRAL (gray or white) wire in the junction box.

Electrical requirements

This appliance must be supplied with the proper voltage and frequency and connected to an individual, properly grounded branch circuit, protected by a circuit breaker or fuse.

See the rating plate located on the side trim to determine the rating of the product. Use the chart below to determine to minimum recommended dedecated circuit protection.

kW Rating 240 V	Recommended size (Dedicated) circuit
<4,8 kW	20 Amp

For installations where grounding through the neutral conductor is prohibited.

The main supply data must correspond to the data specified on the rating plate of the appliance. The rating plate is either seen when the door or the lower cover is opened or it is located at the rear wall of the appliance depending on the appliance type.

Rating Plate Location

Open the front door to see the rating label.

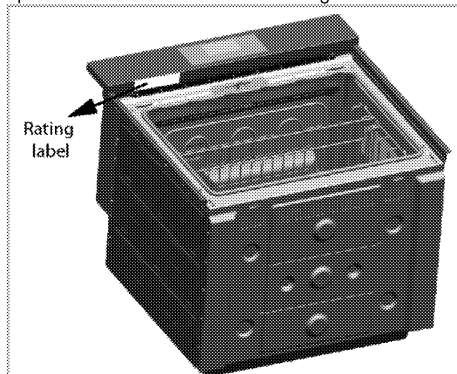

For equipment with a cooling fan

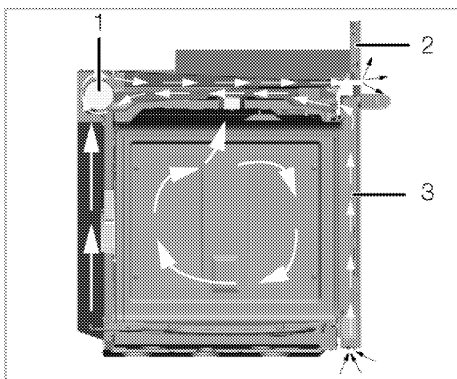

- 1 Fan
- 2 Control panel
- 3 Door

The Built-in cooling fan cools both the built-in cabinet and the front of the appliance.



Cooling fan continues to run for up to 20-30 minutes (approx.) even after the oven is turned off.

3 Preparation

Tips for saving energy

The following information will help you to use your appliance in an ecological way, and to save energy:

- Use dark colored or enamel coated cookware in the oven since the heat transmission will be better.
- While cooking your meals, perform a preheating operation if it is advised in the user manual or cooking instructions.
- During cooking, do not open the oven door frequently.
- Try to cook more than one type of meal with in the oven at the same time (You can cook two different meals at the same time by locating cooking bowls on the same shelf). It will be suitable to cook more than one meal after each other. The oven will already be hot.
- Defrost frozen meals before cooking them.
- You can save energy by switching off your oven a few minutes before the end of the cooking time. (The oven door should not be opened).

Initial use

Before first usage of your appliance, don't forget to remove the sticker on the control panel.

Setting the time



IMPORTANT:

Default setting for clock is 12:00 after initial powering.



IMPORTANT:

Active time setting automatically reset when power failure. Please set the clock again..

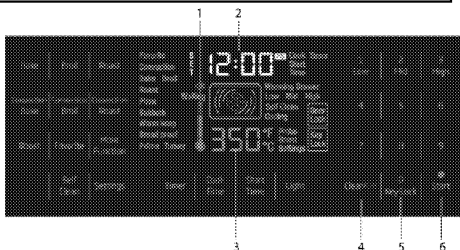

1 Symbol of internal temperature

- 2 Display of active clock
 - 3 Display of set temperature
 - 4 Clear/Off touchpad
 - 5 Key Lock touchpad to disable all keys.
 - 6 Start/Approve touchpad for cooking
1. Touch the "Settings" touchpad once.



2. Display of timer, "Time" and "Settings" touch pads flash.
3. Set the clock with using numeric keypad.
4. When desired time entered, set the time by pressing "Start" or wait approximately 10 seconds.
5. After making 12 hours setting, you can perform AM-PM selection by using button number 8.

Setting 12hr – 24 hr

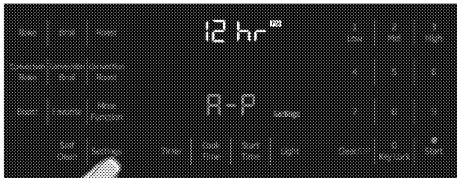

1. Touch the "Settings" touchpad three times.
2. "Settings" touchpad flashes.
3. Adjust 12 hr or 24 hr with touching 1 and 2 in the numeric keypad.
4. Set the 12-hr or 24-hr by pressing "Start" or wait approximately 10 seconds.

First cleaning of the appliance



IMPORTANT:

When removing appliance for cleaning and/or service; Disconnect AC power supply. Carefully remove the range by pulling outward. Range is heavy, use care in handling.



The surface might get damaged by some detergents or cleaning materials. Do not use aggressive detergents, cleaning powders/creams or any sharp objects during cleaning. Be careful to avoid steam burn. Some cleaners can produce noxious fumes if applied to a hot surface.

1. Remove all packaging materials.
2. Wipe the surfaces of the appliance with a damp cloth or sponge and dry with a cloth.

Initial heating



IMPORTANT:

Smoke and smell may emit for a couple of hours during the initial operation. This is quite normal. Ensure that the room is well ventilated to remove the smoke and smell. Avoid directly inhaling the smoke and the smell that emits.

Heat up the product for about 30 minutes and then switch it off. Thus, any production residues or layers will be burnt off and removed.



WARNING

Hot surfaces cause burns!
Product may be hot when it is in use. Never touch the hot burners, inner sections of the oven, heaters and etc. Keep children away. Always use heat resistant oven gloves when putting in or removing dishes into/from the hot oven.

Electric oven

1. Take all baking trays and the wire grill out of the oven.
2. Close the oven door.
3. Select the bake function.
4. Set the temperature 350° F (175 °C).
5. Operate the oven about 30 minutes.
6. Turn off your oven.

Broil

1. Take all baking trays and the wire grill out of the oven.
2. Select the broil function.
3. Set the broil level to "HI".
3. Operate the broil about 30 minutes.
4. Turn off your oven.



Smoke and smell may emit for a couple of hours during the initial operation. This is quite normal. Ensure that the room is well ventilated to remove the smoke and smell. Avoid directly inhaling the smoke and the smell that emits.

4 How to operate the oven

General information on baking, roasting and broiling



WARNING

Hot surfaces cause burns!
Product may be hot when it is in use. Never touch the hot burners, inner sections of the oven, heaters and etc. Keep children away. Always use heat resistant oven gloves when putting in or removing dishes into/from the hot oven.



DANGER:

Be careful when opening the oven door as steam may escape.
Exiting steam can scald your hands, face and/or eyes.

Tips for baking

- Use non-sticky coated appropriate metal plates or aluminum vessels or heat-resistant silicone moulds.
- Make best use of the space on the rack.
- Place the baking mould in the middle of the shelf.
- Select the correct rack position before turning the oven or Broil on. Do not change the rack position when the oven is hot.
- Always place oven racks in desired location while oven is cool. If rack must be moved while oven is hot, do not let potholder contact hot heating element in oven.
- Keep the oven door closed.

Tips for roasting

- Seasoning with lemon juice and black pepper will improve the cooking performance when cooking a whole chicken, turkey or a large piece of meat.
- Meat with bones takes about 15 to 30 minutes longer before it is cooked than a roast of the same size without bones.
- You should calculate about 4 to 5 minutes cooking time per centimeter height of the meat.
- Let meat rest in the oven for about 10 minutes after the cooking time. The juice is better distributed all over the roast and does not run out when the meat is cut.

- Fish in a fire-resistant dish should be placed on the rack at the medium or lower level.

Tips for broiling

Broiling is ideal for cooking meat, fish and poultry and will achieve a nice brown surface without it drying out to much. Flat pieces, meat skewers and sausages are particularly suited for broiling as are vegetables with a high water content such as tomatoes and onions.

- Distribute the pieces to be broiled on the wire shelf.
- If the broiling is on the wire shelf, locate a dripping pan under it in order to collect the fat.
- Add some water in dripping pan for easy cleaning.



Fire danger due to food which is unsuitable for grilling!

Only use food for grilling which is suitable for intensive grilling heat.
Do not place the food too far in the back of the grill. This is the hottest area and fat food may catch fire.



Fan only runs if necessary for improving performance of cooking and saving the energy of the oven.

Tips for cooking vegetables

1. If the vegetable dish runs out of juice and gets to dry,
» Since using a lid during cooking will keep the juice of the dish in the pan, cook your vegetable dishes in a pan with a lid instead of a tray.
2. If a vegetable dish does not get cooked,
» Boil the vegetables beforehand or prepare them like canned food and put in the oven.

How to use the electric oven



CAUTION: Food Poisoning Hazard

Do not let food sit in oven more than one hour before or after cooking.
Doing so can result in food poisoning or sickness.



IMPORTANT:

Before using the oven, the clock time must be set. If the clock time is not set, the main oven will not work.



WARNING

Never cover any slots, holes or passges in the oven bottom or cover an entire rack with materials such as aluminium foil. Doing so blocks airflow through the oven and may cause carbonmonoxide poisoning. Aluminium foil linings may also trap heat, causing a fire hazard.



Fire Hazard!

Never leave the range unattended with the cooktop on medium or high settings. Keep flammable items away from the cooktop. Turn off all controls when done cooking. Failure to follow these instructions can result in fire, serious injury or death..

Settings Temperature Unit

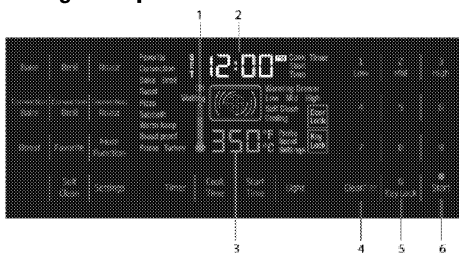

- 1 Symbol of internal temperature
 - 2 Display of active clock
 - 3 Display of set temperature
 - 4 Clear/Off touchpad
 - 5 Key Lock touchpad to disable all keys.
 - 6 Start/Approve touchpad for cooking
1. Touch the "Settings" touchpad four times.



2. "Settings" touchpad and icon of °F or °C flashing.



3. Adjust °F or °C with touching 1 and 2 in the numeric keypad.
4. When desired unit entered, set the temperature unit by touching "Start" or wait approximately 10 seconds.

Switch on the electric oven

Stand-by mode is active when oven has power. The display shows only active time. When stand-by mode is active;

Bake

Broil

Roast

Convection Broil

Convection Bake

Convection Roast

More Function

Shelf positions

For optimum broil coverage, position the wire shelf towards the front of the oven just out of contact with the glass door. Placing the wire shelf fully to the rear of the oven will reduce the broil coverage. It is important to position the wire shelf on side rack correctly. The wire shelf must be placed so that it will fit into the opening of the wire shelf as illustrated in the figure.

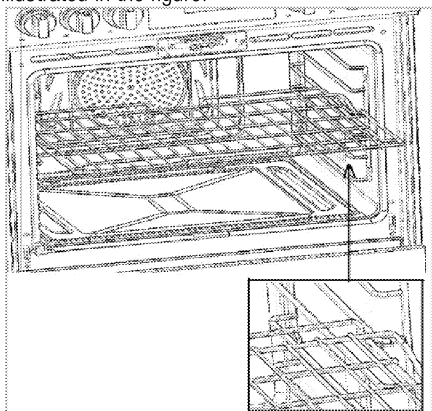

Self Clean
Settings
Light
Key lock
Favorite

Timer touch pads are active.

Setting Temperature and Function Mode

Sample display for initial operation mode of oven functions.

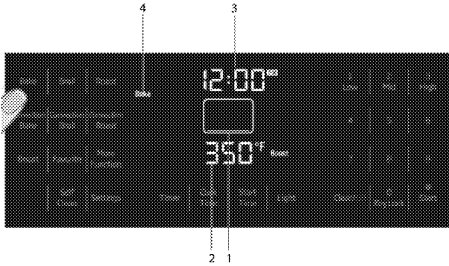

- 1 Functions icon
- 2 Area of set temperature
- 3 Area of active clock
- 4 Function mode name

Recommended temperature is shown in the area of set temperature and working heaters or components are shown in the functions icon.

“Temperature”, “Cook Time”, “Cook End Time” can be adjustable when functions are selected.

Temperature should be adjustable when functions (except Broil, Convection Broil, Warm Keep and Warming Drawer) are firstly selected. Set temperature adjusts with numeric keypad.

You can change set temperature after starting cook. If you want to change set temperature after starting cook, touch same function and change set temperature.

Broil, Convection Broil, Warm Keep and Warming Drawer functions’ temperature can adjust with pressing 1-Low, 2-Mid and 3-High in the numeric keypad.

Function Table

Function table indicates the functions that can be used in the oven and their respective maximum, minimum and initial display temperatures.

FUNCTION	RECOMENDED TEMPERATURE	LOW	MID	HIGH	MAX	MIN
	°F / °C	°F / °C	°F / °C	°F / °C	°F / °C	°F / °C
BAKE	350/175				550/290	125/50
CON BAKE	350/175				550/290	125/50
BROIL	350/175	350/175	450/230	550/290		
CON BROIL	350/175	350/175	450/230	550/290		
ROAST	375/190				550/290	125/50
CON ROAST	350/175				550/290	125/50
PIZZA	425/220				550/290	125/50
SABBATH	350/175				450/230	125/50
WARM KEEP	150/65	150/65	170/75	200/95		
BREAD PROOF	100/40				125/50	100/40
PRIME TURKEY	325/165				550/290	125/50
SELF CLEAN		3 HOURS	4 HOURS	5 HOURS		

Using the meat probe

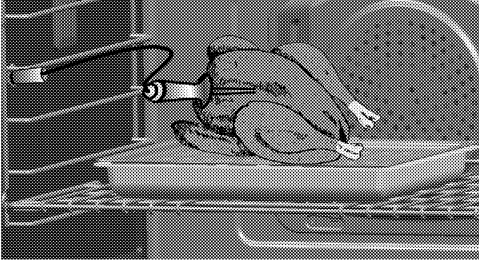

The probe is used to measure the central temperature of meats and poultry such as chicken or turkey by sticking the thin and long part into the meat and attaching the other end to its slot on the side wall of the chassis.

Measured inner temperature of the food indicates the doneness level of the meat. "Probe" appears on the display of the oven when the probe is attached to its slot on the side wall of the chassis. It can be used with the Probe; Bake, Convection Bake, Roast, Convection Roast, Prime Turkey functions.

Using the probe:

1. Select one of the oven functions which allows using the probe.
2. To adjust the food central temperature, enter the food central temperature with the numbers on the right hand side while °F or °C is blinking and press "Start".
3. To adjust the oven inner temperature, enter the oven inner temperature with the numbers on the right hand side while °F or °C is blinking. And then press "Start" to start cooking.
4. The temperature that appears on the display during cooking is the food central temperature measured by the probe.
5. Cooking is terminated automatically once the adjusted food central temperature is attained.



CAUTION

Use of probes other than the one provided with this product may result in damage to the probe or oven control.



CAUTION

Use the handles of the probe and plug when inserting and removing them from the food and outlet.



CAUTION

To avoid damaging your probe, do not use tongs to pull on the cable when removing it.



CAUTION

Insert the probe completely into the meat. It should not touch bone, fat or gristle.



CAUTION

For roasts with no bone, insert the probe into the meatiest part of the roast. For bone-in ham or lamb, insert the probe into the center of the lowest large muscle.



CAUTION

Insert the probe into the center of dishes such as meat loaf or casseroles.



CAUTION

Insert the probe into the meatiest part of the inner thigh from below and parallel to the leg of a whole turkey.

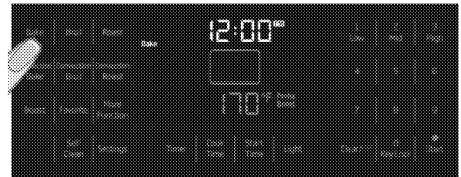

In functions where the meat probe is used, "Probe" symbol appears on the display and flashes with an interval of about 1 sec as illustrated in the image.

The "Probe" symbol also appears for the functions where the meat probe is not used. The "Probe" symbol flashes rapidly on the display.













WARNING

Never store the probe inside the oven when it is not in use.



WARNING

Take the meat probe out of the oven when the Self-Clean mode is activated.

	WARNING Do not remove the probe from its slot on the side wall when the cooking is over; wait for it to cool down. Heat may cause burns..
	CAUTION There is the risk of fracture for the thin and long part of the probe when the probe is stuck into the frozen food. Wait for the frozen food to thaw and use the probe with thawed food.
	WARNING Use heat-resistant gloves to remove the probe when the cooking is over.
	CAUTION Stick the probe to the center of the food. If the tip of the probe is close to the bone or surface of the meat, cooking will be terminated before the de-sired doneness level is attained.
	CAUTION Failure to fully insert the probe into the meat may result in poor cooking performance because the probe will sense the oven air vs. the food temperature..
	CAUTION Food central temperature can be set between 100-210°F (40-100 °C).
	Cooking time is not indicated when the meat probe is attached..
	It is not suggested to set the cooking time for the best cooking results with meat probe.
	In case of cooking without meat probe, the oven temperature and the oven set temperature are displayed alternately until the oven temperature reaches the set temperature. After that, oven set temperature displayed.
	In case of cooking with meat probe, the oven temperature and the oven set temperature are displayed alternately until the oven temperature reaches the set temperature. After that, meat probe's real temperature displayed.
	Cooking cannot be started in functions where the meat probe cannot be used.

Operating modes

Bake

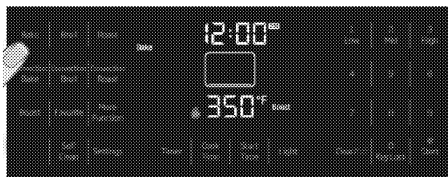

Only bottom heat is on. The bake mode can be used for a variety of food items, from cakes to casseroles.

Bake food on a single rack with the pans are positioned in the middle of the oven. Bake foods with 1" (25mm) to 1.5" (38mm) space between pans and oven walls.

When using the Bake mode, preheat the oven for best results.

Baking time will vary with the size, shape and material of the pan used.

Convection Bake

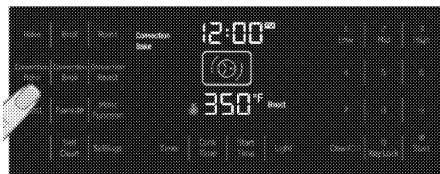

Only right heater is on. The heat comes from back of steel plate and is circulated throughout the oven by the convection fan. The convection bake mode can be used for a variety of food items, from cakes to breads.

It is also ideal for sponge cakes, pasties and biscuits on multiple racks (3 and 5) at the same time and large quantities of baked foods.

The cakes are positioned with the top rack cakes towards the back of the oven and the lower rack cakes towards the front of the oven. Bake foods with 1" (25mm) to 1.5" (38mm) space between pans and oven walls.

When using the Convection Bake mode, preheat the oven for best results.

Baking time will vary with the size, shape and material of the pan used.

Broil

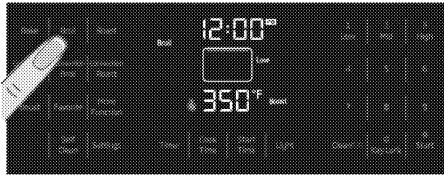

Top heat is on. The broil mode can be used for cuts of meat, poultry and fish. It can also be used to brown breads. The food must be put on a grid in a pan (broiler tray).

Broil food on a single rack with the broiler tray are centrally located with respect to the heating element.

The broil mode has three settings: low 350°F (175°C), mid 450°F (230°C), high 550°F (290°C).

When using the Broil mode, preheat the oven 5-6 minutes for best results.

Turn foods once during the recommended cook time.

The size, weight, thickness, starting temperature and personal preference of doneness will affect broiling times.

Convection Broil

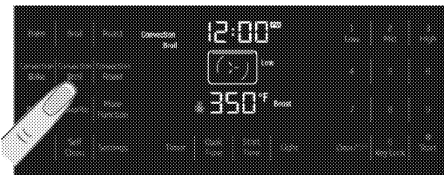

Top heat is on. The heat comes from top and is circulated throughout the oven by the convection fan. The convection broil mode can be used for cuts of meat, poultry and fish. The food must be put on a grid in a pan (broiler tray).

Broil food on a single rack with the broiler tray are centrally located with respect to the heating element.

The convection broil mode has three settings: low (350°F (175°C)), mid (450°F (230°C)), high (550°F (290°C)).

When using the Convection Broil mode, preheat the oven 5-6 minutes for best results.

Turn foods once during the recommended cook time.

The size, weight, thickness, starting temperature and personal preference of doneness will affect broiling times.

Roast

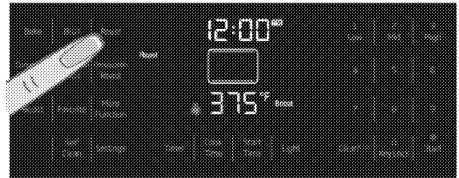

Top and bottom heat are on. The roast mode can be used for meat and poultry.

Roast food on a single rack with the pan is positioned in the middle of the oven.

When using the Roast mode, preheat the oven for best results.

For best performance, use a pan and grid (roasting tray or broiler tray) under the meat or poultry. The pan catches grease spills.



WARNING
You can use a lid or roasting bags in this mode. Follow manufacturer's directions for the roasting bag.

Convection Roast

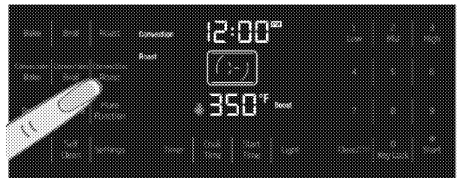

Top and bottom heat are on. The heat comes from top and bottom and is circulated throughout the oven by the convection fan. The convection roast mode can be used for meat, poultry and large quantities of roasted foods.

Roast food on a single rack with the pan is positioned in the middle of the oven.

When using the Convection Roast mode, preheat the oven for best results.

For best performance, use a pan and grid (roasting tray or broiler tray) under the meat or poultry. The pan catches grease spills.



WARNING
Do not cover meat or use roasting bags in this mode.

Self-cleaning function



WARNING:

If the oven is hot, self cleaning mode cannot be operated until the oven is cold. If the self cleaning mode malfunctions (power cut), turn the oven off and disconnect the power supply, and call the service.



DANGER:

Hot surfaces cause burns!

Do not touch the product during self cleaning step and keep children away from it. Keep at least 30 minutes before removing the remnants.



WARNING:

The oven is equipped with self-cleaning function. The oven is heated to approx. 790 °F and existing dirt is burned to ashes. A strong smoke development may arise. Provide for good ventilation.

The self-cleaning should be used after approx. every 10th oven usage.

The self-cleaning has three levels. It can be selected according to level of dirtiness.

Low level (Low): it takes 3 hours.

Medium Level (Mid): it takes 4 hours.

High Level (High): it takes 5 hours.



WARNING:

Remove all accessories from the oven.



WARNING:

If the self-cleaning mode malfunctions, turn the oven off and disconnect the power supply. Have it serviced by a qualified technician.



WARNING:

Before operating the self-clean cycle, Wipe grease and food soils from the oven. Excessive amount of grease may ignite, leading to smoke damage to your home.



WARNING:

Do not clean the door gasket. Fiberglass gasket is highly sensitive and can get damaged easily. In case of a damage on the oven door gasket, replace with the new one from the authorized service.



WARNING:

Before operating the self-clean cycle, remove dirt from exterior surfaces and oven interior with a damp cloth, wipe grease and food soils from the oven. Excessive amount of grease may ignite, leading to smoke damage to your home. Remove all accessories from the oven.

1. Before the self-cleaning cycle, remove dirt from exterior surfaces and oven interior with a damp cloth.
2. Keep the function knob pressed and turn it clockwise to desired level of "Clean". (Low, Mid or High).

This duration cannot be changed.



WARNING:

The health of some birds and pets is extremely sensitive to the fumes given off during the Self-Cleaning cycle. Always move birds and pets to another closed and well ventilated room. Keep the kitchen well-ventilated during the Self-Cleaning cycle also for your health.

3. If there is a fire in the oven during self-clean, turn the oven off and wait for the fire to go out. Do not force the door open. Introduction of fresh air at self-clean temperatures may lead to a burst of flame from the oven. Failure to follow this instruction may result in severe burns.



CAUTION:

After a clean cycle, remove soil deposits with vinegar water.



During the Self-Cleaning cycle, the electrical flow to hob burners will be cut. After turning the function and thermostat knob to off position, the door lock will be automatically opened. When the oven gets cool, the electrical flow to hob burners will be started.



During the Self-Cleaning cycle, the lamp cannot be operated.



WARNING:

If there is a fire in the oven during self-clean, turn the oven off and wait for the fire to go out. Do not force the door open. Introduction of fresh air at self-clean temperatures may led

to a burst of flame from the oven. Failure to follow this instruction may result in severe burns.

Pizza

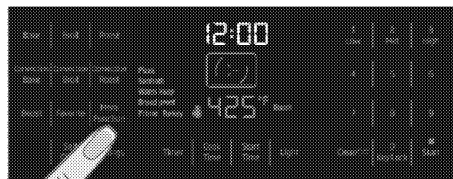

Bottom heat is on. The heat comes from bottom and is circulated throughout the oven by the convection fan. The pizza mode can be used for fresh and frozen pizza. Follow manufacturer's directions for frozen pizza.

For best performance, use a pizza pan or baking tray.

You can also use pizza stone but follow manufacturer's directions for the pizza stone.

Bake pizza on a single rack with the pizza pan or baking tray is positioned in the middle of the oven.

When using the Pizza mode, preheat the oven for best results.

Sabbath

Only bottom heat is on.

Cook food on a single rack with the pans are positioned in the middle of the oven. Cook foods with 1" (25mm) to 1" ½ "(38mm) space between pans and oven walls.

The Sabbath mode can be start with touching Sabbath function and START button.

The temperature must be with range of 125°F (50°C) to 450°F (230°C).with in the Sabbath mode.



All control button except CLEAR/OFF button is deactivated when Sabbath mode is active.



If Sabbath mode is wanted to close, both CLEAR/OFF and LIGHT buttons are touched simultaneously for approximately 2 seconds.



The maximum time for Sabbath mode is 72 hours if you set the cook time.



CLEAR/OFF button closes the all heaters when Sabbath mode is active but the appearance of display is not changed.



IMPORTANT:
Light is off when the Sabbath function in use. No change in light if you press the button without Sabbath mode.



IMPORTANT:
You cannot change the oven temperature after Sabbath starts.



IMPORTANT:
All acoustic signals is deactivated when Sabbath mode is active.



IMPORTANT:
If you set the Cook Time in Sabbath mode, all heaters are closed but the appearance of display is not changed after the Cook Time finished.



The maximum time for Sabbath mode is 75 hours if you do not use Cook Time.



WARNING:
Food Poisoning Hazard: Do not let food sit in oven for more than 1 hour before or after cooking. Doing so can result in food poisoning or sickness.



WARNING:
To avoid permanent damage to the oven bottom finish do not line the oven bottom with any type of foil or liner.



WARNING:
Sabbath mode should be used only on the Jewish Sabbath and Holidays.

WARNING:
The health of some birds and pets is extremely sensitive to the fumes given off during the Sabbath mode. Always move birds and pets to another closed and well ventilated room. Keep the kitchen well-ventilated during the Sabbath mode also for your health.

i All food should be placed in the oven before the Sabbath begins, since none may be placed in the oven during the Sabbath.

i On the Sabbath the oven door may only be opened once, all the food removed and then closed. On the Holidays, the oven door may be opened/closed at any time as often as desired.

i After recovery from a power failure, the oven will return to the start up screen.

i The start time can be adjusted max.12 hours at Sabbath mode. Make sure the oven clock shows the correct time of day.

Recommendations

Temperature	Food type
Low	Soft rolls, chips, empty dinner plates
Medium	Casseroles, pizza, vegetables, eggs, pastries, biscuits, hard rolls, gravies
High	Roasts, poultry, hamburgers, bacon, potatoes (baked)

CAUTION:
Put the cooked food in heat-safe serving dish on the rack in the oven.
Remove serving spoons etc. before placing dishes in the oven.

WARNING:
Do not leave paper products, plastics, canned food or combustible materials in the drawer. They may ignite.

WARNING:
Do not leave paper products, plastics, canned food or combustible materials in the drawer. They may ignite.

WARNING:
Fire risk!
Do not store flammable material in the oven and/or in the warming drawer.

Warm Keep

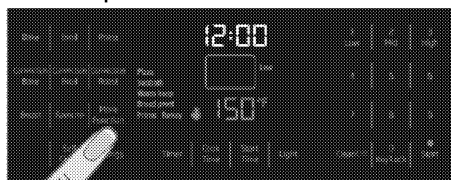

Only bottom heat is on. The warm keep mode will keep hot, cooked foods at serving temperature. Always start with hot food. Cold or room temperature foods cannot be heated or warmed in this mode (except crisping crackers, chips, dry cereal).

Bacteria will grow very rapidly in food that in between 40°F (4,5°C) and 140°F (60°C). Always preheat the oven before warming food. For best results, do not warm food longer than one hour.

The warm keep mode has three settings: low (150°F(65°C)), mid (170°F(75°C)), high (200°F(95°C)).

Bread Proof

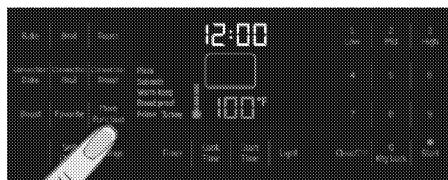

Only bottom heat is on. The bread proof mode can be used leavening of the bread and pizza dough or other yeast dough.

Use a bowl or a pan with lid or cover.

Proof dough on a single rack with bowl or a pan is positioned in the middle of the oven.

No preheat is necessary.

Prime Turkey

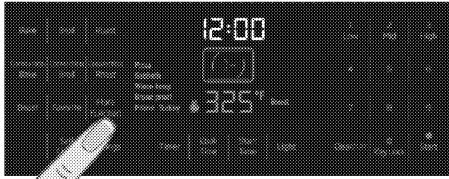

Top and bottom heat are on. The heat comes from top and bottom and is circulated throughout the oven by the convection fan. The Prime Turkey mode can be used for whole or parts of turkey.

Roast turkey on a single rack with the pans are positioned in the middle of the oven.

When using the Prime Turkey mode, preheat the oven for best results.

Always use a pan and grid (roasting tray or broiler tray) under whole or parts of Turkey. The pan catches grease spills.

	WARNING: Do not cover meat or use roasting bags in this mode.
	IMPORTANT: Maximum adjustable cooking time in modes is limited with 6 hours due to safety reasons. It is limited with 5 hours for Self Clean.
	IMPORTANT: While adjusting any function, related symbols will flash on the display.
	IMPORTANT: Program will be canceled in case of power failure. You must reprogram the appliance.

How to operate the oven control unit

Activating semi-automatic operation mode

In this operation mode, you may adjust the time period during which the oven will operate (cooking time).

1. Put your meal into the oven and close the oven door.
2. Select the desired oven function.
3. If you want to change the temperature adjust the temperature using numbers on the right side while °F or °C is flashing.
4. For cooking time, touch the 'Cook Time' key once.
 - » Enter the cooking time using numbers on the right keypad while Cook and Time are flashing.

5. Once the cooking time is set, Cook and Time symbols will appear on the display continuously.

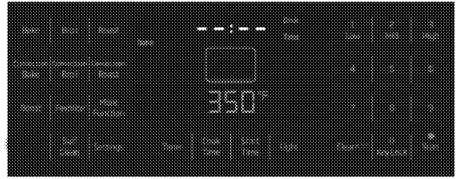

6. If cooking function, temperature and time values are suitable, touch Start to start cooking. Cooking starts and "ON" appears on the display.

» The oven will be heated up to the preset temperature and will maintain this temperature until the end of the cooking time you selected.

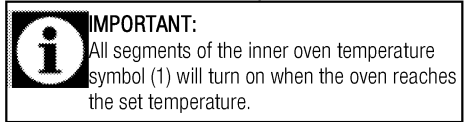

7. After the cooking is completed, the oven will give an audible warning.
8. To stop the alarm signal, just touch any key.

Switch on fully automatic operation

In this operation mode you can adjust cooking time and end of cooking time.

1. Put your meal into the oven and close the oven door.
2. Select the desired oven function.
3. If you want to change the temperature adjust the temperature using numbers on the right side while °F or °C is flashing.
4. For cooking time, touch the 'Cook Time' key once.
 - » Enter the cooking time using numbers on the right keypad while Cook and Time are flashing.

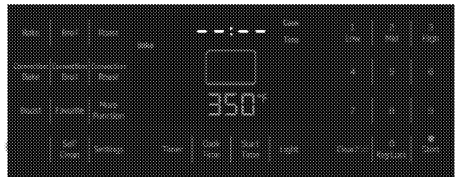

5. Touch "Start Time" key once for end of cooking time. Enter end of cooking time using numbers on the right while Start and Time are flashing.

6. When end of cooking time is set, end of cooking time and the Start and Time symbols will appear on the display continuously.

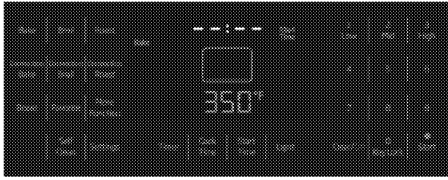

7. If cooking function, temperature, time and end of cooking time values are suitable, touch "Start" key to start cooking. "Cooking" appears on the display.
- » Oven timer automatically calculates the startup time for cooking by deducting the cooking time from the end of cooking time you have set.
8. Selected operation mode is activated when the startup time of cooking has come. "ON" appears on display and oven heats up to the adjusted temperature. It maintains this temperature until the end of the cooking time.

IMPORTANT:
All segments of the inner oven temperature symbol (1) will turn on when the oven reaches the set temperature.

9. After the cooking is completed, the oven will give an audible warning.
10. To stop the alarm signal, just touch any key.

IMPORTANT:
If you want to cancel the program after performing semi-automatic or automatic programming, you need to reset the cooking time. You can also switch off the oven by touching the "Clear/Off" key.

IMPORTANT:
In case of malfunction of the "Clear/Off" key, you can touch any other program selector keys to switch off the oven.

Setting the booster(for only electric ovens) (Quick heating)

Use Booster (rapid pre-heating) function to make the oven reach the desired temperature faster.

IMPORTANT:
Booster cannot be selected in Warm Keep, Self Clean and Bread Proof cooking positions. Booster will be set by default in other positions. If you do not want to use Booster function, disable it by pressing 'Booster' key.

1. If cooking function, temperature and time values are suitable, touch Start to start cooking. Cooking starts and 'ON' appears on the display.
 - » 'Booster' disappears from the display as soon as the oven reaches the desired temperature and oven resumes operating in the function it was in before the Booster function.
2. Touch the 'Booster' key again in order to enable or disable booster function. If 'Booster' appears on the display, it means it is enabled. If not, it means it is disabled.

Using the key lock

You can prevent oven from being intervened with by activating the key lock function.

IMPORTANT:
Key lock can be enabled only when the oven is in Standby position and operating mode.

Activating the key lock

Key lock is activated by pressing 0-Key Lock key amongst the numbers on the right of display for approximately 3 seconds.

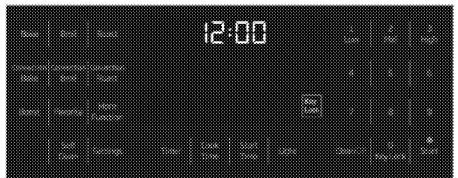

Deactivating the key lock

Key Lock is deactivated by pressing 0-Key Lock key amongst the numbers on the right of display for approximately 3 seconds.

IMPORTANT:
Oven keys are not functional when the key lock function is activated. Key lock will be canceled in case of power failure.

Using the timer as an alarm clock

You can use the timer of the product for any warning or reminder apart from the cooking

program. The alarm clock has no influence on the functions of the oven. It is only used as a warning. For example, this is useful when you want to turn food in the oven at a certain point of time. Alarm clock will give a signal once the time you set is over.

i **IMPORTANT:**
Maximum alarm period can be 6 hours.

To set the alarm:

Press 'Timer' key on display and set the desired alarm period by entering the alarm period using the numbers on the right of the display. It will be activated after about 10 seconds when no key is pressed.

After the alarm period is over, 'Timer' will start flashing and an alarm signal is heard. To stop the alarm signal, just touch any key.

To cancel the alarm:

Touch 'Timer' key when alarm is set. When you set the time to 00:00, the alarm will be canceled about 10 seconds later and 'Timer' symbol on display will disappear.

Turning the light on and off

Every time you touch 'Light' key on display, it will be turned on if it is off or vice versa.

i **IMPORTANT:**
If Self Clean is active, light will be off at all times. Pressing 'Light' key does not change this.

i **IMPORTANT:**
If internal temperature of the oven exceeds 572°F (300°C), light will be off at all times. Pressing 'Light' key does not change this.

i **IMPORTANT:**
While oven functions are on, all heaters will be switched off when Clear/Off key is pressed.

i **IMPORTANT:**
If oven door is opened when turbo fan is on, turbo fan will be stopped.

i **IMPORTANT:**
If oven door is opened when an oven function is active, all heaters will be deactivated after about 30 seconds.

There are lights on keys. Descriptions of these lights are given in the table below

Using the Favorite Mode

Saving the Favorite Function

When a cooking function is on display, current values will be saved as your favorite meal when you touch "Favorite" key for about 3 seconds.

i **IMPORTANT:**
1 menu will be saved as Favorite meal. Therefore, when you save a new meal, previously saved meal will be deleted and the latest will be stored.

i **IMPORTANT:**
Bake and Set values are preset as "Favorite" meal in the initial setup.

Selecting the favorite menu

Favorite menu will appear on display when you touch "Favorite" key for 1 second when the oven is on.

Touch the 'Start' key to activate cooking.

Standby position of timer

Once the time of the day is set up on the unit, timer display will show the time and the manual cooking symbol will be lit, indicating that the unit is in Standby position. Manual cooking symbol will always be on the display when the unit is not in use. Neither any indicators nor any heater elements on the unit are active at this position.

This indicates that oven can be operated manually without setting the timer. If you wish to make a programmed cooking operation in the oven, please follow the steps to activate the oven timer on page 27.



OFF position of timer

You can bring the timer to the OFF position. At OFF position even turn on the function knob, timer do not allow heaters on. To set timer to the OFF position when it is at Standby mode:

1. Press to button 2.

2. If you cannot see 0:00 on display, by pressing 5 and 6 buttons adjust it to 0:00.
3. If you see already 0:00 on the display, by pressing button 6 make display 0:01. Then by pressing button 5 make it 0:00 again.
4. You will hear alarm sound. Press button 3 to switch off the alarm sound. You will see "AUTO" is blinking and the display shows time of the day.

Now timer is in OFF position. It is the same position when you first time connect your product to the main supply. First cleaning of supply.

Cooking times table



IMPORTANT:

The values indicated in the table below are data indicative. They may vary according to the type of food as well as your preferences of cooking.



IMPORTANT:

Level 1 is the **bottom** level in the oven.

Baking and roasting

Food	Cooking Mode	Oven Temperature (°F-°C)	Number of Racks	Rack Position	Time (min.)	Pan Size&Type	Explanation
Sponge Cake	Bake	350/175	Single	3	20-30	8" or 9" (200-230 mm) round	The cakes are positioned in the middle of the oven. Bake foods with 1" (25mm) to 1.5" (38mm) space between pans and oven walls.
Sponge Cake	Convection Bake	350/175	Multiple	2&4	30-40	8" or 9" (200-230 mm) round	The cakes are positioned with the top rack cakes towards the front of the oven and the lower rack cakes towards the back of the oven. Bake foods with 1" (25mm) to 1.5" (38mm) space between pans and oven walls.
Loaf (leavened*)	Bake	400/205	Single	3	30-40	Baking tray	-
Loaf (leavened*)	Convection Bake	400/205	Single	3	25-35	Baking tray	-
Puff pastry	Convection Bake	375/190	Multiple	2&4	15-25	Cookie sheet	The cakes are positioned with the top rack cakes towards the front of the oven and the lower rack cakes towards the back of the oven. Bake foods with 1" (25mm) to 1.5" (38mm) space oven walls.
Fresh pizza, thin	Pizza	425/220	Single	2	8-15	Pizza pan or Baking tray	-
Fresh pizza, thick	Pizza	425/220	Single	2	12-20	Pizza pan or Baking tray	-
Frozen pizza, thick	Pizza	425/220	Single	2	10-15	Pizza pan or Baking tray	-
Chicken, whole (4-4.5 lbs.)	Convection Roast	375/190	Single	2	120-140	Roasting pan or broiler tray	Minimum internal temperature is 180°F (82 °C) in thigh
Turkey, whole, unstuffed (18-20 lbs.)	Prime Turkey	325/160	Single	1	150-180	Roasting pan	Minimum internal temperature is 180°F (82 °C) in thigh. Foil the top surface of turkey to prevent over-browning in last 30 minutes of the cooking, if necessary.
Sirloin, boneless (4-4.5 lbs.)	Convection Roast	325/160	Single	3	90-120	Broiler tray	Internal temperature is 145°F (62 °C) (medium rare), 160°F (71 °C) (medium)
Toast bread	Broil	High	Single	5	2-2:30	Broiler tray	Place broiler tray centrally located with respect to the heating element.
Chicken thigh (2-2.5 lbs)	Broil	High	Single	4	Side 1: 16-20	Broiler tray	Place broiler tray centrally located with respect to the heating element.

					Side 2: 8-12		Minimum internal temperature is 180°F (82 °C) in thigh.
Chicken thigh (2-2.5 lbs)	Broil	Mid	Single	4	Side 1: 20-24 Side 2: 14-16	Broiler tray	Place broiler tray centrally located with respect to the heating element. Minimum internal temperature is 180°F (82 °C) in thigh.
Ground beef (0.3"-0.5" thick, 6 patties)	Broil	High	Single	4	Side 1: 5-7 Side 2: 3-5	Broiler tray	Place broiler tray centrally located with respect to the heating element.
Hamburger, frozen (0.3"-0.5" thick, 6 patties)	Broil	High	Single	4	Side 1: 7-10 Side 2: 2-4	Broiler tray	Place broiler tray centrally located with respect to the heating element.
*Leavening	Bread Proof	100/40	Single	3	30-40	Bowl or pan with cover	
**It is suggested to perform preheating for all foods cooking. It is suggested to perform 5-6 minutes preheating for all foods broiling.							

(**) For preheating, set the required temperature, the thermostat lamp will go out when the required temperature is reached.

How to operate the broil



IMPORTANT:

Before using the oven the clock time must be set. If the clock time is not set, the main oven will not work.



WARNING:

Hot surfaces may cause burns!
Close oven door during broiling.

Switch on broil

1. Touch to "Broil" the function knob onto the broil symbol.

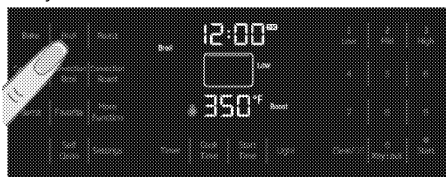

2. Set broil mode. The broil mode has three settings: low 350°F (175°C), mid 450°F (230°C), high 550°F (290°C).
3. Preheat for approximately 5 minutes, if it is necessary.

5 Maintenance and care

General information

Service life of the product will extend and the possibility of problems will decrease if the product is cleaned at regular intervals.



DANGER:
Risk of electric shock!

Switch off the electricity before cleaning appliance to avoid an electric shock.



DANGER:
Hot surfaces may cause burns!

Allow the appliance to cool down before you clean it.



IMPORTANT:

The surface might get damaged by some detergents or cleaning materials. Do not use aggressive detergents, cleaning powder/cream or any sharp objects. Do not use aggressive detergents, cleaning powder/cream or any sharp objects.

- Clean the appliance thoroughly after each use; in this way it will be possible to remove cooking residues more easily, thus avoiding these from burning the next time the appliance is used.



IMPORTANT:

No special cleaning agents are required for cleaning the appliance. It is recommended to use warm water with washing liquid, a soft cloth or sponge and use a dry cloth for drying.

- **Do not use any abrasive cleaning materials!**



The surface might get damaged by some detergents or cleaning materials. Do not use aggressive detergents, cleaning powders/creams or any sharp objects during cleaning.

Do not use harsh abrasive cleaners or sharp metal scrapers to clean the oven door glass since they can scratch the surface, which may result in shattering of the glass.



WARNING:

Do not use steam cleaners to clean the appliance as this may cause an electric shock.

Cleaning the control panel

Clean the control panel and knobs with a damp cloth and wipe them dry.



IMPORTANT:

Damage of the control panel!
Do not remove the control knobs for control panel cleaning.

Cleaning the oven

No oven cleaner or any other special cleaning agent is required for cleaning the oven. It is recommended to wipe the oven with a damp cloth while it is still warm.



WARNING:

Do not use oven cleaners. No commercial oven cleaner or oven liner protective coating of any kind should be used in or around any part of the oven.

Self-cleaning function



WARNING:

If the oven is hot, self cleaning mode cannot be operated until the oven is cold. If the self cleaning mode malfunctions (power cut), turn the oven off and disconnect the power supply, and call the service.



DANGER:

Hot surfaces cause burns!
Do not touch the product during self cleaning step and keep children away from it. Keep at least 30 minutes before removing the remnants.



WARNING:

The oven is equipped with self-cleaning function. The oven is heated to approx. 790 °F and existing dirt is burned to ashes. A strong smoke development may arise. Provide for good ventilation.

The self-cleaning should be used after approx. every 10th oven usage.

The self-cleaning has three levels. It can be selected according to level of dirtiness.

Low level (Low): it takes 3 hours.

Medium Level (Mid): it takes 4 hours.

High Level (High): it takes 5 hours.

 **WARNING:**
Remove all accessories from the oven.

 **WARNING:**
If the self-cleaning mode malfunctions, turn the oven off and disconnect the power supply. Have it serviced by a qualified technician.

 **WARNING:**
Before operating the self-clean cycle, Wipe grease and food soils from the oven. Excessive amount of grease may ignite, leading to smoke damage to your home.

 **WARNING:**
Do not clean the door gasket. Fiberglass gasket is highly sensitive and can get damaged easily. In case of a damage on the oven door gasket, replace with the new one from the authorized service.

 **WARNING:**
Before operating the self-clean cycle, remove dirt from exterior surfaces and oven interior with a damp cloth, wipe grease and food soils from the oven. Excessive amount of grease may ignite, leading to smoke damage to your home. Remove all accessories from the oven.

1. Before the self-cleaning cycle, remove dirt from exterior surfaces and oven interior with a damp cloth.
2. Keep the function knob pressed and turn it clockwise to desired level of "Clean". (Low, Mid or High).

This duration cannot be changed.

 **WARNING:**
The health of some birds and pets is extremely sensitive to the fumes given off during the Self-Cleaning cycle. Always move birds and pets to another closed and well ventilated room. Keep the kitchen well-ventilated during the Self-Cleaning cycle also for your health.

3. If there is a fire in the oven during self-clean, turn the oven off and wait for the fire to go out. Do not force the door open. Introduction of fresh air at self-clean temperatures may lead to a burst of flame from the oven. Failure

to follow this instruction may result in severe burns.

 **CAUTION:**
After a clean cycle, remove soil deposits with vinegar water.

 During the Self-Cleaning cycle, the electrical flow to hob burners will be cut. After turning the function and thermostat knob to off position, the door lock will be automatically opened. When the oven gets cool, the electrical flow to hob burners will be started.

 During the Self-Cleaning cycle, the lamp cannot be operated.

 **WARNING:**
If there is a fire in the oven during self-clean, turn the oven off and wait for the fire to go out. Do not force the door open. Introduction of fresh air at self-clean temperatures may lead to a burst of flame from the oven. Failure to follow this instruction may result in severe burns.

Clean oven door

To clean the oven door, use warm water with washing liquid, a soft cloth or sponge to clean the product and wipe it with a dry cloth.

 Don't use any harsh abrasive cleaners or sharp metal scrapers for cleaning the oven door. They could scratch the surface and destroy the glass.

Removing the oven door

When removing the oven door, make sure oven is cool and power to the oven has been turned off before removing the door.

Failure to do so could result in electrical shock or burns.

The oven door is heavy and parts of it are fragile. Use both hands to remove the oven door. The door front is glass. Handle carefully to avoid breakage.

Grasp only the sides of the oven door. Do not grasp the handle as it may swing in your hand and cause damage or injury.

Failure to grasp the oven door firmly and properly could result in personal injury or product damage.

To avoid injury from hinge bracket snapping

closed, be sure that both levers are securely in place before removing the door. Also, do not force door open or closed—the hinge could be damaged and injury could result.

Do not lay removed door on sharp or pointed objects as this could break the glass. Lay on a flat, smooth surface, positioned so that the door cannot fall over.

Oven door can be removed in order to clean the inside of oven easily

1. Open the oven door completely.
2. Press the hinge clamps located at both sides of the door backwards.

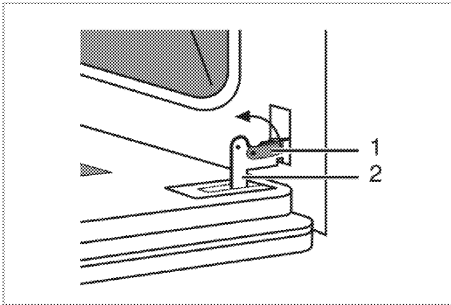

- 1 Hinge clamp
- 2 Hinge

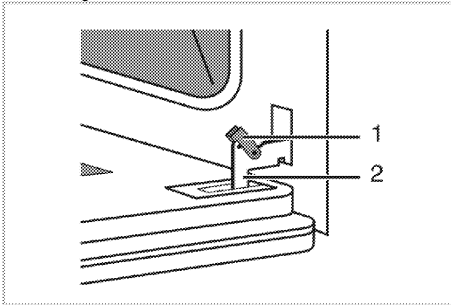

3. Move the oven door to a slightly inclined position.
4. Raise the oven door forwards with your two hands.
5. Once you complete cleaning, perform the same procedure in reverse order to reinstall the oven door.

i Once you complete cleaning, perform the same procedure in reverse order to reinstall the oven door.

Replacing the oven lamp



DANGER:

Before replacing the oven lamp, make sure that the product is disconnected from mains and cooled down in order to avoid the risk of an electrical shock.
Hot surfaces may cause burns!



In this oven, an incandescent lamp with a power of less than 40 W, a height of less than 60 mm, a diameter of less than 30 mm or a halogen lamp with socket type G9, a power of less than 60 W is used. The lamps are suitable for operation at temperatures above 300 °C. Oven lamps can be obtained from Authorised Service Agents or technician with licence.



Position of lamp might vary from the figure.

If your oven is equipped with a square lamp:

The oven lights can be illuminated with light key. The lights are switched on when the door is opened or when the oven is in a cooking cycle. The oven lights are not illuminated during self clean. Each light assembly consists of a removable lens, a light bulb as well as a light socket housing that is fixed in place. Light bulb replacement is considered to be a routine maintenance item.

1. Turn off power at the main power supply (your fuse or breaker box).
2. Remove the wire racks as described. See *Cleaning the oven*.

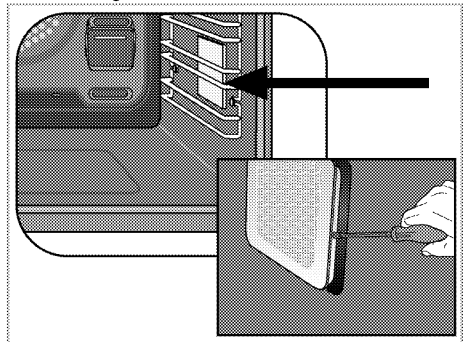

3. Remove the protective glass cover with a screwdriver.
4. Pull out oven lamp and replace it with new one.
5. Install the glass cover and then the wire racks.

6 General information

Overview

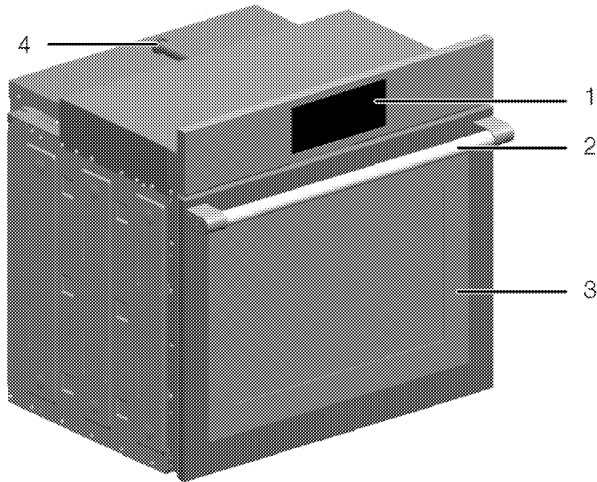

- 1 Control panel
- 2 Handle

- 3 Front door
- 4 Supply cord

Technical specifications

GENERAL	
Outer dimensions (height/width/depth)	733 mm(28" 7/8) /755 mm(29" 3/4) /620 mm (24" 7/16)
Voltage / frequency	220- 240V~60Hz 2AC~N
Total electric power	3,7 kW
Fuse protection	Min. 20 A
Cable type / cross section	BC-SIL 4X13 AWG
Cable length	max. 4ft
Inside Illumination	
Bake	2240 W
Broil	3320 W
Convection Roast	3670 W
* Powers are for 230 V 2AC ~ N	



Technical specifications may be changed without prior notice to improve the quality of the product.



Figures in this manual are schematic and may not exactly match your product.



Values stated on the product labels or in the documentation accompanying it are obtained in laboratory conditions in accordance with relevant standards. Depending on operational and environmental conditions of the product, these values may vary.

Package contents



WARNING:

Pull the oven rack to the stop-lock position when loading and unloading food from the oven. This helps prevent burns from touching hot surfaces of the door and oven walls.



CAUTION:

When you are using a rack in the lowest position (A), you will need to use caution when pulling the rack out. We recommend that you pull the rack out several inches and then, using two pot holders, pull the rack out by holding the sides of it. The rack is low and you could be burned if you place your hand in the middle of the rack and pull all the way out. Be very careful not to burn your hand on the door when using the rack in the lowest position (A).



Accessories supplied can vary depending on the product model. Not every accessory described in the user manual may exist on your product.

1. **User manual**

2. **Oven tray**

Used for pastries, frozen foods and big roasts.

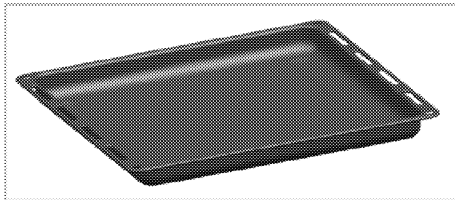

3. **Wire Shelf**

Used for roasting and for placing the food to be baked, roasted or cooked in casserole dishes to the desired rack.

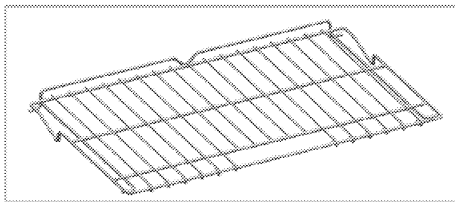

4. **Broiler tray**

It is placed onto the tray in order to collect the dripping fat while grilling so that the oven is kept clean.

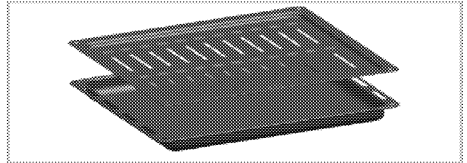
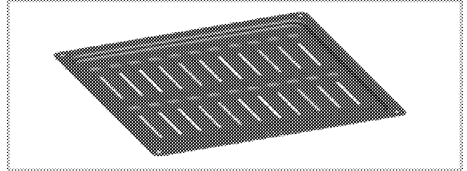

5. **Placing the wire shelf and tray onto the telescopic racks properly**

Telescopic racks allow you to install and remove the trays and wire shelf easily. When using the tray and wire shelf with telescopic racks, make sure that the pins at the rear section of the telescopic rack stands against the edges of the wire shelf and tray.

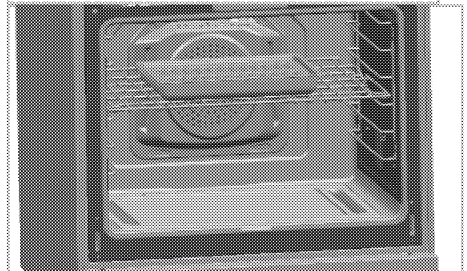
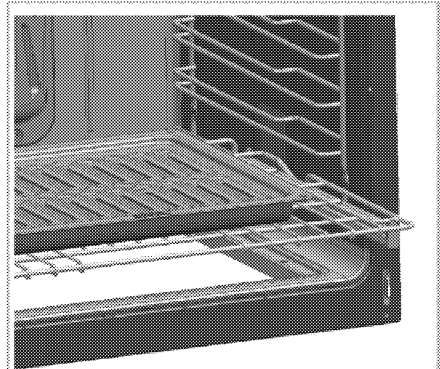

7 Troubleshooting

Oven emits steam when it is in use.

- It is normal that steam escapes during operation. >>> *This is not a fault.*

Product emits metal noises while heating and cooling.

- When the metal parts are heated, they may expand and cause noise. >>> *This is not a fault.*

Product does not operate.

- The mains fuse is defective or has tripped. >>> *Check fuses in the fuse box. If necessary, replace or reset them.*
- Product is not plugged into the (grounded) socket. >>> *Check the plug connection.*
- Buttons/knobs/keys on the control panel do not function. >>> *Keylock may be enabled. Please disable it. (See. Using the keylock, page*

Oven light does not work.

- Oven lamp is defective. >>> *Replace oven lamp.*
- Power is cut. >>> *Check if there is power. Check the fuses in the fuse box. If necessary, replace or reset the fuses.*

Oven does not heat.

- Function and/or Temperature are not set. >>> *Set the function and the temperature with the Function and/or Temperature knob/key.*
- In models equipped with a timer, the timer is not adjusted. >>> *Adjust the time.* (In products with microwave oven, timer controls only microwave oven.)
- Power is cut. >>> *Check if there is power. Check the fuses in the fuse box. If necessary, replace or reset the fuses.*

(In models with timer) Clock display is blinking or clock symbol is on.

- A previous power outage has occurred. >>> *Adjust the time / Switch of the product and switch it on again.*



Consult the Authorised Service Agent or the dealer where you have purchased the product if you can not remedy the trouble although you have implemented the instructions in this section. Never attempt to repair a defective product yourself.

8 BEKO US RESIDENTIAL PRODUCT WARRANTY

The warranties provided by Beko in these statements only apply to Beko appliance sold to the original purchaser or homeowner in the US (Including Alaska, Hawaii, Puerto Rico and the US Virgin Islands) and The Cayman Islands

The factory warranty applies only to products purchased through an authorized dealer or authorized reseller. Go to www.bekoappliances.com/where-to-buy for a list of authorized dealers. Products purchased through non-authorized dealers and wholesalers will not be covered under the manufacturer's warranty

The warranty is not transferable. To obtain warranty service, please contact your dealer or contact us at

<https://www.bekoappliances.com/support/beforecallcenter/>

You will need your product model number, serial number, retailer name and address, where purchased and purchase date / installation date. This warranty gives you specific legal rights, and you may also have other rights which vary from state to state. Also, please make sure you register your product for warranty at:

<https://www.bekoappliances.com/product-registration/>

2 year (*) full warranty from date of first installation (All Beko Products)

Beko will repair or replace at no cost to the consumer any defective parts product if used under normal household conditions

(Warranty is void if the product is used commercially e.g., bed + breakfast, nursing home etc.). Service must also be performed by an authorized Beko service agency. (Cosmetic defects must be reported within 10 business days from installation). 1 year warranty on the accessories is for the parts only and does not include labor.

3rd thru 5th year (*, **) Sealed System Warranty on refrigerators - Parts Only

Beko will provide (No Charge) any compressor, evaporator, condenser and filter dryer to the consumer if material defects or workmanship have caused the damage or failure of these components.

(Trip and Labor charges are the responsibility of the consumer)

3rd thru 10th year (*, **) ProSmart™ Inverter Motor on Dishwashers – Part Only

Beko will provide (No Charge) a ProSmart Inverter Main Wash Motor if material defects or workmanship have caused the damage or failure of this component.

(Trip and Labor charges are the responsibility of the consumer)

Disclaimers of warranties and exclusions:

Warranty does not cover service costs by an authorized service agent to correct installation, electrical problems or educational instruction on the use of the electric and gas ranges. The warranty also does not cover defects or damage caused by an act of God (such as storms, floods, fires, mudslides, etc.), damage caused by use of the electric and gas ranges for purposes other than those for

which it was designed, misuse, abuse, accident, alteration, improper installation, maintenance, travel fees, service calls outside normal service hours, pick up and delivery, any food loss due to product failure, unauthorized service work or work.

This product is fully tested and went through official quality assurance inspections before leaving the original manufacturing site. Warranty terms for this Beko household appliance is not valid if the product is altered, tampered, modified, additional parts assembled, fixed and re-packed by an authorized distributor, servicer, a third party retailer, reseller or by any other unauthorized person(s).

TO THE EXTENT PERMITTED BY LAW, THIS WARRANTY IS IN LIEU OF ALL OTHER EXPRESSED AND IMPLIED WARRANTIES, INCLUDING THE IMPLIED WARRANTIES OF MERCHANTABILITY AND FITNESS FOR A PARTICULAR PURPOSE. BEKO UNDERTAKES NO RESPONSIBILITY FOR THE QUALITY OF THIS PRODUCT EXCEPT AS OTHERWISE PROVIDED IN THIS WARRANTY STATEMENT. BEKO ASSUMES NO RESPONSIBILITY THAT THE PRODUCT WILL BE FIT FOR ANY PARTICULAR PURPOSE FOR WHICH YOU MAY BE BUYING THIS PRODUCT, EXCEPT AS OTHERWISE PROVIDED IN THIS WARRANTY STATEMENT.

Beko does not assume any responsibility for incidental or consequential damages. Such damages include, but are not limited to, loss of profits, loss of savings or revenue, loss of use of the electric and gas ranges or any associated equipment, cost of capital, cost of any substitute equipment, facilities or services, downtime, the claims of third parties, and injury to property. Some states do not allow the exclusion or limitation of incidental or consequential damages, so the above limitations or exclusion may not apply to you.

(*) Installation date shall refer to either purchase date or 5 business days after delivery of the product to the home, whichever is later.

() Parts replaced will assume the identity of the original parts + their original warranty.**

No Other Warranties. This Warranty Statement is the complete and exclusive warranty from the manufacturer. No employee of Beko or any other party is authorized to make any warranty statements in addition to those made in this Warranty Statement.

Please keep this warranty card, user manual and your sales slip for future reference.

HOW TO CONTACT BEKO

Please contact Beko US at 1 (888) 352-2356 and select option 2 for customer service

HOW TO GET SERVICE

Please contact your authorized Beko dealer or visit www.bekoappliances.com to locate and get information for the closest authorized Beko service center.

